

z/OS



# XL C/C++ User's Guide



z/OS



# XL C/C++ User's Guide

**Note!**

Before using this information and the product it supports, be sure to read the information in "Notices" on page 625.

**Sixth Edition (September 2006)**

This edition applies to Version 1 Release 8 of z/OS XL C/C++ (5694-A01), Version 1 Release 8 of z/OS.e XL C/C++ (5655-G52), and to all subsequent releases until otherwise indicated in new editions. This edition replaces SC09-4767-04. Make sure that you use the correct edition for the level of the program listed above. Also, ensure that you apply all necessary PTFs for the program.

Order publications through your IBM representative or the IBM branch office serving your location. Publications are not stocked at the address below. You can also browse the books on the World Wide Web by clicking on "The Library" link on the z/OS home page. The web address for this page is [www.ibm.com/servers/eserver/zseries/zos/bkserv](http://www.ibm.com/servers/eserver/zseries/zos/bkserv)

IBM welcomes your comments. You can send your comments to the following Internet address: [compinfo@ca.ibm.com](mailto:compinfo@ca.ibm.com). Be sure to include your e-mail address if you want a reply.

Include the title and order number of this book, and the page number or topic related to your comment. When you send information to IBM, you grant IBM a nonexclusive right to use or distribute the information in any way it believes appropriate without incurring any obligation to you.

© Copyright International Business Machines Corporation 1996, 2006. All rights reserved.

US Government Users Restricted Rights – Use, duplication or disclosure restricted by GSA ADP Schedule Contract with IBM Corp.

---

# Contents

|   |   |       |
|---|---|-------|
|   | <b>About this document</b> . . . . .          | xv    |
| I | Typographical conventions . . . . .           | xv    |
|   | How to read syntax diagrams . . . . .         | xvi   |
|   | Symbols . . . . .                             | xvi   |
|   | Syntax items . . . . .                        | xvi   |
|   | Syntax examples . . . . .                     | xvii  |
|   | z/OS XL C/C++ and related documents . . . . . | xvii  |
|   | Softcopy documents . . . . .                  | xxii  |
|   | Softcopy examples . . . . .                   | xxii  |
|   | z/OS XL C/C++ on the World Wide Web . . . . . | xxiii |
|   | Where to find more information . . . . .      | xxiii |
| I | Technical support . . . . .                   | xxiv  |
| I | How to send your comments . . . . .           | xxv   |

---

## Part 1. Introduction . . . . . 1

|   |   |    |
|---|---|----|
|   | <b>Chapter 1. About IBM z/OS XL C/C++</b> . . . . .                             | 3  |
| I | Changes for z/OS V1R8 . . . . .   | 3  |
|   | The XL C/C++ compilers . . . . .  | 6  |
|   | The C language . . . . .  | 6  |
|   | The C++ language . . . . .  | 6  |
|   | Common features of the z/OS XL C and XL C++ compilers . . . . .                 | 6  |
|   | z/OS XL C compiler-specific features . . . . .                                  | 8  |
|   | z/OS XL C++ compiler-specific features . . . . .                                | 8  |
|   | Class libraries . . . . .   | 8  |
|   | Utilities . . . . .   | 9  |
|   | dbx . . . . .   | 9  |
|   | z/OS Language Environment . . . . .   | 9  |
|   | z/OS Language Environment downward compatibility . . . . .                      | 10 |
|   | About prelinking, linking, and binding . . . . .                                | 11 |
|   | Notes on the prelinking process . . . . .                                       | 12 |
|   | File format considerations . . . . .  | 13 |
|   | The program management binder . . . . .   | 13 |
|   | z/OS UNIX System Services . . . . .   | 13 |
|   | z/OS XL C/C++ applications with z/OS UNIX System Services C functions . . . . . | 15 |
|   | Input and output . . . . .  | 15 |
|   | I/O interfaces . . . . .  | 15 |
|   | File types . . . . .  | 16 |
|   | Additional I/O features . . . . .   | 17 |
|   | The System Programming C facility . . . . .                                     | 17 |
|   | Interaction with other IBM products . . . . .                                   | 18 |
|   | Additional features of z/OS XL C/C++ . . . . .                                  | 20 |

---

## Part 2. User's reference . . . . . 23

|  |   |    |
|--|---|----|
|  | <b>Chapter 2. z/OS XL C example</b> . . . . .                   | 25 |
|  | Example of a C program . . . . .                                | 25 |
|  | CCNUAAM . . . . .   | 25 |
|  | CCNUAAN . . . . .   | 26 |
|  | Compiling, binding, and running the z/OS XL C example . . . . . | 27 |
|  | Under z/OS batch . . . . .                                      | 27 |
|  | Non-XPLINK and XPLINK under TSO . . . . .                       | 28 |

|   |           |
|---|-----------|
| Non-XPLINK and XPLINK under the z/OS UNIX System Services shell . . . . . | 29        |
| <b>Chapter 3. z/OS XL C++ examples . . . . .</b>                          | <b>31</b> |
| Example of a C++ program . . . . .  | 31        |
| CCNUBRH . . . . .   | 32        |
| CCNUBRC . . . . .   | 34        |
| Compiling, binding, and running the z/OS XL C++ example . . . . .         | 36        |
| Under z/OS batch . . . . .  | 36        |
| Non-XPLINK and XPLINK under TSO . . . . .                                 | 37        |
| Non-XPLINK and XPLINK under the z/OS UNIX shell . . . . .                 | 38        |
| Example of a C++ template program . . . . .                               | 39        |
| CLB3ATMP.CXX . . . . .  | 40        |
| Compiling, binding, and running the C++ template example . . . . .        | 41        |
| Under z/OS batch . . . . .  | 41        |
| Under TSO . . . . .   | 43        |
| Under the z/OS UNIX shell . . . . .                                       | 44        |
| <b>Chapter 4. Compiler Options . . . . .</b>                              | <b>45</b> |
| Specifying compiler options . . . . .                                     | 45        |
| IPA considerations . . . . .  | 46        |
| Using special characters . . . . .  | 48        |
| Specifying z/OS XL C compiler options using #pragma options . . . . .     | 49        |
| Specifying compiler options under z/OS UNIX System Services . . . . .     | 49        |
| Compiler option defaults . . . . .  | 50        |
| Summary of compiler options . . . . .                                     | 53        |
| Compiler options for file management . . . . .                            | 56        |
| Options that control the preprocessor . . . . .                           | 57        |
| Options that control the processing of an input source file . . . . .     | 58        |
| Options that control the compiler listing . . . . .                       | 58        |
| Options that control the IPA object . . . . .                             | 60        |
| Options that control the IPA Link step . . . . .                          | 60        |
| Options for debugging and diagnosing errors . . . . .                     | 61        |
| Options that control the programming language characteristics . . . . .   | 62        |
| Options that control object code generation . . . . .                     | 63        |
| Options that control program execution . . . . .                          | 66        |
| Portability options . . . . .   | 66        |
| Description of compiler options . . . . .                                 | 67        |
| AGGRCOPY . . . . .  | 67        |
| AGGREGATE   NOAGGREGATE . . . . .   | 68        |
| ALIAS   NOALIAS . . . . .   | 68        |
| ANSIALIAS   NOANSIALIAS . . . . .   | 69        |
| ARCHITECTURE . . . . .  | 72        |
| ARGPARSE   NOARGPARSE . . . . .   | 74        |
| ASCII   NOASCII . . . . .   | 75        |
| ATTRIBUTE   NOATTRIBUTE . . . . .   | 76        |
| BITFIELD(SIGNED)   BITFIELD(UNSIGNED) . . . . .                           | 77        |
| CHARS(SIGNED)   CHARS(UNSIGNED) . . . . .                                 | 77        |
| CHECKOUT   NOCHECKOUT . . . . .   | 78        |
| CICS   NOCICS . . . . .   | 80        |
| COMPACT   NOCOMPACT . . . . .   | 82        |
| COMPRESS   NOCOMPRESS . . . . .   | 83        |
| CONVLIT   NOCONVLIT . . . . .   | 84        |
| CSECT   NOCSECT . . . . .   | 86        |
| CVFT   NOCVFT . . . . .   | 89        |
| DBRMLIB . . . . .   | 90        |
| DEBUG   NODEBUG . . . . .   | 91        |

I

|                             |     |
|-----------------------------|-----|
| DEFINE                      | 94  |
| DIGRAPH   NODIGRAPH         | 95  |
| DLL   NODLL                 | 97  |
| ENUMSIZE                    | 99  |
| EVENTS   NOEVENTS           | 101 |
| EXECOPS   NOEXECOPS         | 102 |
| EXH   NOEXH                 | 103 |
| EXPMAC   NOEXPMAC           | 103 |
| EXPORTALL   NOEXPORTALL     | 104 |
| FASTTEMPINC   NOFASTTEMPINC | 104 |
| FLAG   NOFLAG               | 105 |
| FLOAT                       | 106 |
| GOFF   NOGOFF               | 111 |
| GONUMBER   NOGONUMBER       | 111 |
| HALT(num)                   | 113 |
| HALTONMSG   NOHALTONMSG     | 113 |
| HGPR   NOHGPR               | 114 |
| HOT   NOHOT                 | 114 |
| IGNERRNO   NOIGNERRNO       | 115 |
| INFO   NOINFO               | 116 |
| INITAUTO   NOINITAUTO       | 118 |
| INLINE   NOINLINE           | 119 |
| INLRPT   NOINLRPT           | 123 |
| IPA   NOIPA                 | 124 |
| KEYWORD   NOKEYWORD         | 132 |
| LANGLVL                     | 132 |
| LIBANSI   NOLIBANSI         | 145 |
| LIST   NOLIST               | 146 |
| LOCALE   NOLOCALE           | 148 |
| LONGNAME   NOLONGNAME       | 149 |
| LP64   ILP32                | 150 |
| LSEARCH   NOLSEARCH         | 153 |
| MARGINS   NOMARGINS         | 158 |
| MAXMEM   NOMAXMEM           | 159 |
| MEMORY   NOMEMORY           | 161 |
| NAMEMANGLING                | 161 |
| NESTINC   NONESTINC         | 163 |
| OBJECT   NOOBJECT           | 163 |
| OBJECTMODEL                 | 165 |
| OE   NOOE                   | 165 |
| OFFSET   NOOFFSET           | 166 |
| OPTFILE   NOOPTFILE         | 167 |
| OPTIMIZE   NOOPTIMIZE       | 169 |
| PHASEID   NOPHASEID         | 172 |
| PLIST                       | 173 |
| PORT   NOPORT               | 174 |
| PPONLY   NOPPONLY           | 175 |
| REDIR   NOREDIR             | 178 |
| RENT   NORENT               | 178 |
| ROCONST   NOROCONST         | 179 |
| ROSTRING   NOROSTRING       | 181 |
| ROUND                       | 182 |
| RTTI   NORTTI               | 183 |
| SEARCH   NOSEARCH           | 183 |
| SEQUENCE   NOSEQUENCE       | 185 |
| SERVICE   NOSERVICE         | 186 |

|   |            |
|---|------------|
| SHOWINC   NOSHOWINC . . . . .                                     | 187        |
| SOURCE   NOSOURCE . . . . .                                       | 187        |
| SPILL   NOSPILL . . . . .   | 188        |
| SPLITLIST   NOSPLITLIST . . . . .                                 | 190        |
| SQL   NOSQL . . . . .   | 193        |
| SSCOMM   NOSSCOMM . . . . .                                       | 194        |
| START   NOSTART . . . . .   | 195        |
| STATICINLINE   NOSTATICINLINE . . . . .                           | 195        |
| STRICT   NOSTRICT . . . . .                                       | 196        |
| STRICT_INDUCTION   NOSTRICT_INDUCTION . . . . .                   | 197        |
| SUPPRESS   NOSUPPRESS . . . . .                                   | 198        |
| TARGET . . . . .  | 198        |
| TEMPINC   NOTEMPINC . . . . .                                     | 203        |
| TEMPLATERECOMPILE   NOTEMPLATERECOMPILE . . . . .                 | 204        |
| TEMPLATEREGISTRY   NOTEMPLATEREGISTRY . . . . .                   | 205        |
| TERMINAL   NOTERMINAL . . . . .                                   | 206        |
| TEST   NOTEST . . . . .   | 206        |
| TMPLPARSE . . . . .   | 210        |
| TUNE . . . . .  | 211        |
| UNDEFINE . . . . .  | 213        |
| UNROLL . . . . .  | 213        |
| UPCONV   NOUPCONV . . . . .                                       | 214        |
| WARN64   NOWARN64 . . . . .                                       | 215        |
| WSIZEOF   NOWSIZEOF . . . . .                                     | 215        |
| XPLINK   NOXPLINK . . . . .                                       | 216        |
| XREF   NOXREF . . . . .   | 220        |
| Using the z/OS XL C compiler listing . . . . .                    | 220        |
| IPA considerations . . . . .                                      | 221        |
| Example of a C compiler listing . . . . .                         | 221        |
| z/OS XL C compiler listing components . . . . .                   | 254        |
| Using the z/OS XL C++ compiler listing . . . . .                  | 257        |
| IPA considerations . . . . .                                      | 258        |
| Example of a C++ compiler listing . . . . .                       | 258        |
| z/OS XL C++ compiler listing components . . . . .                 | 268        |
| Using the IPA Link step listing . . . . .                         | 271        |
| Example of an IPA Link step listing . . . . .                     | 272        |
| IPA Link step listing components . . . . .                        | 277        |
| <br>  |            |
| <b>Chapter 5. Binder options and control statements . . . . .</b> | <b>285</b> |
| <br>  |            |
| <b>Chapter 6. Run-Time options . . . . .</b>                      | <b>287</b> |
| Specifying run-time options . . . . .                             | 287        |
| Using the #pragma runopts preprocessor directive . . . . .        | 287        |

---

**Part 3. Compiling, binding, and running z/OS XL C/C++ programs . . . . . 289**

|  |            |
|--|------------|
| <b>Chapter 7. Compiling . . . . .</b>                | <b>291</b> |
| Input to the z/OS XL C/C++ compiler . . . . .        | 291        |
| Primary input . . . . .                              | 291        |
| Secondary input . . . . .                            | 292        |
| Output from the compiler . . . . .                   | 292        |
| Specifying output files . . . . .                    | 292        |
| Valid input/output file types . . . . .              | 295        |
| Compiling under z/OS batch . . . . .                 | 296        |
| Using cataloged procedures for z/OS XL C . . . . .   | 297        |
| Using cataloged procedures for z/OS XL C++ . . . . . | 297        |



|  |            |
|--|------------|
| Using special characters . . . . .   | 298        |
| Examples of compiling programs using your own JCL . . . . .  | 298        |
| Specifying source files . . . . .  | 300        |
| Specifying include files . . . . .   | 301        |
| Specifying output files . . . . .  | 302        |
| Compiling under TSO . . . . .  | 302        |
| Using the CC and CXX REXX EXECs . . . . .  | 302        |
| Specifying sequential and partitioned data sets . . . . .  | 303        |
| Specifying z/OS UNIX files or directories . . . . .  | 304        |
| Compiling and binding in the z/OS UNIX System Services environment . . . . .                                 | 305        |
| Compiling without binding using compiler invocation command names supported by c89 and xlc . . . . .         | 307        |
| Compiling and binding in one step using compiler invocation command names supported by c89 and xlc . . . . . | 309        |
| Building an application with XPLINK using the c89 or xlc utilities . . . . .                                 | 310        |
| Building a 64-bit application using the c89 or xlc utilities . . . . .                                       | 310        |
| Invoking IPA using the c89 or xlc utilities . . . . .  | 310        |
| Using IPA(OBJONLY) with the c89 or xlc utilities . . . . .   | 311        |
| Using the make utility . . . . .   | 311        |
| Compiling with IPA . . . . .   | 312        |
| The IPA Compile step . . . . .   | 312        |
| The IPA Link step . . . . .  | 313        |
| Compiling with IPA(OBJONLY) . . . . .  | 314        |
| Working with object files . . . . .  | 315        |
| Browsing object files . . . . .  | 315        |
| Identifying object file variations . . . . .   | 316        |
| Using feature test macros . . . . .  | 316        |
| Using include files . . . . .  | 316        |
| Specifying include file names . . . . .  | 317        |
| Forming file names . . . . .   | 317        |
| Forming data set names with LSEARCH   SEARCH options . . . . .   | 318        |
| Search sequence . . . . .  | 320        |
| Determining whether the file name is in absolute form . . . . .  | 321        |
| Using SEARCH and LSEARCH . . . . .   | 323        |
| Search sequences for include files . . . . .   | 325        |
| With the NOOE option . . . . .   | 325        |
| With the OE option . . . . .   | 326        |
| Compiling z/OS XL C source code using the SEARCH option . . . . .  | 327        |
| Compiling z/OS XL C++ source code using the SEARCH option . . . . .  | 328        |
| <b>Chapter 8. Using the IPA Link step with z/OS XL C/C++ programs . . . . .</b>                              | <b>329</b> |
| Invoking IPA using the c89 and xlc utilities . . . . .   | 329        |
| Specifying options . . . . .   | 330        |
| Other considerations . . . . .   | 330        |
| Compiling under z/OS batch . . . . .   | 331        |
| Using cataloged procedures for IPA Link . . . . .  | 331        |
| Creating a module with IPA . . . . .   | 331        |
| Example 1. all C parts . . . . .   | 331        |
| Example 2. all C parts built with XPLINK . . . . .   | 341        |
| Creating a DLL with IPA . . . . .  | 343        |
| Example 1. a mixture of C and C++ . . . . .  | 343        |
| Example 2. using the IPA control file . . . . .  | 345        |
| Using Profile-Directed Feedback (PDF) . . . . .  | 347        |
| Steps for utilizing PDF optimization . . . . .   | 347        |
| Steps for building a module in UNIX System Services using PDF . . . . .                                      | 349        |
| Reference Information . . . . .  | 349        |

|   |            |
|---|------------|
| IPA Link step control file . . . . .  | 349        |
| Object file directives understood by IPA . . . . .                                | 354        |
| Troubleshooting . . . . .   | 354        |
| <b>Chapter 9. Binding z/OS XL C/C++ programs . . . . .</b>                        | <b>355</b> |
| When you can use the binder . . . . .   | 355        |
| When you cannot use the binder . . . . .  | 355        |
| Your output is a PDS, not a PDSE . . . . .  | 355        |
| CICS . . . . .  | 355        |
| MTF . . . . .   | 355        |
| IPA . . . . .   | 355        |
| Using different methods to bind . . . . .   | 356        |
| Single final bind . . . . .   | 356        |
| Bind each compile unit . . . . .  | 357        |
| Build and use a DLL . . . . .   | 358        |
| Rebind a changed compile unit . . . . .   | 360        |
| Binding under z/OS UNIX System Services . . . . .                                 | 360        |
| z/OS UNIX System Services example . . . . .                                       | 361        |
| Steps for single final bind using c89 . . . . .                                   | 361        |
| Steps for binding each compile unit using c89 . . . . .                           | 362        |
| Steps for building and using a DLL using c89 . . . . .                            | 363        |
| Steps for rebinding a changed compile unit using c89 . . . . .                    | 364        |
| Using the non-XPLINK version of the Standard C++ Library and c89 . . . . .        | 365        |
| Using the non-XPLINK version of the Standard C++ Library and xlc . . . . .        | 366        |
| Binding under z/OS batch . . . . .  | 366        |
| z/OS batch example . . . . .  | 367        |
| Steps for single final bind under z/OS batch . . . . .                            | 367        |
| Steps for binding each compile unit under z/OS batch . . . . .                    | 368        |
| Steps for building and using a DLL under z/OS batch . . . . .                     | 370        |
| Build and use a 64-bit application under z/OS batch . . . . .                     | 371        |
| Build and use a 64-bit application with IPA under z/OS batch . . . . .            | 372        |
| Using the non-XPLINK version of the Standard C++ Library and z/OS batch . . . . . | 374        |
| Steps for rebinding a changed compile unit under z/OS batch . . . . .             | 375        |
| Writing JCL for the binder . . . . .  | 376        |
| Binding under TSO using CXXBIND . . . . .   | 378        |
| TSO example . . . . .   | 380        |
| Steps for single final bind under TSO . . . . .                                   | 380        |
| Steps for binding each compile unit under TSO . . . . .                           | 381        |
| Steps for building and using a DLL under TSO . . . . .                            | 381        |
| Steps for rebinding a changed compile unit under TSO . . . . .                    | 382        |
| <b>Chapter 10. Binder processing . . . . .</b>                                    | <b>383</b> |
| Linkage considerations . . . . .  | 385        |
| Primary input processing . . . . .  | 385        |
| C or C++ object module as input . . . . .   | 385        |
| Secondary input processing . . . . .  | 385        |
| Load module as input . . . . .  | 385        |
| Program object as input . . . . .   | 385        |
| Autocall input processing (library search) . . . . .                              | 386        |
| Incremental autocall processing (AUTOCALL control statement) . . . . .            | 386        |
| Final autocall processing (SYSLIB) . . . . .                                      | 386        |
| Rename processing . . . . .   | 388        |
| Generating aliases for automatic library call (library search) . . . . .          | 388        |
| Dynamic Link Library (DLL) processing . . . . .                                   | 389        |
| Statically bound functions . . . . .  | 389        |
| Imported variables . . . . .  | 390        |

|  |            |
|--|------------|
| Imported functions . . . . .   | 390        |
| Output program object. . . . .   | 390        |
| Output IMPORT statements. . . . .  | 390        |
| Output listing . . . . .   | 391        |
| Header . . . . .   | 392        |
| Input Event Log . . . . .  | 392        |
| Module Map . . . . .   | 392        |
| Cross Reference Table . . . . .  | 394        |
| Imported and Exported Symbols Listing . . . . .                            | 394        |
| Mangled to Demangled Symbol Cross Reference. . . . .                       | 395        |
| Processing Options . . . . .   | 396        |
| Save Operation Summary . . . . .   | 396        |
| Save Module Attributes . . . . .   | 397        |
| Entry Point and Alias Summary . . . . .                                    | 397        |
| Long Symbol Abbreviation Table . . . . .                                   | 398        |
| DDname vs Pathname Cross Reference Table . . . . .                         | 398        |
| Message Summary Report . . . . .   | 399        |
| Binder processing of C/C++ object to program object . . . . .              | 399        |
| Rebindability . . . . .  | 401        |
| Error recovery. . . . .  | 402        |
| Unresolved symbols . . . . .   | 403        |
| Significance of library search order . . . . .                             | 403        |
| Duplicates . . . . .   | 404        |
| Duplicate functions from autocall . . . . .                                | 406        |
| Hunting down references to unresolved symbols . . . . .                    | 406        |
| Incompatible linkage attributes. . . . .                                   | 407        |
| Non-reentrant DLL problems . . . . .                                       | 407        |
| Code that has been prelinked . . . . .                                     | 407        |
| <b>Chapter 11. Running a C or C++ application.</b> . . . . .               | <b>409</b> |
| Setting the region size for z/OS XL C/C++ applications. . . . .            | 409        |
| Running an application under z/OS batch. . . . .                           | 410        |
| Specifying run-time options under z/OS batch . . . . .                     | 410        |
| Specifying run-time options in the EXEC statement . . . . .                | 411        |
| Using cataloged procedures. . . . .  | 411        |
| Running an application under TSO . . . . .                                 | 412        |
| Specifying run-time options under TSO . . . . .                            | 413        |
| Passing arguments to the z/OS XL C/C++ application . . . . .               | 413        |
| Running an application under z/OS UNIX System Services . . . . .           | 414        |
| z/OS UNIX System Services application environments . . . . .               | 414        |
| Specifying run-time options under z/OS UNIX System Services . . . . .      | 415        |
| Restriction on using 24-bit AMODE programs . . . . .                       | 415        |
| Copying applications between a PDS and z/OS UNIX System Services . . . . . | 415        |
| Running a data set member from the z/OS shell . . . . .                    | 415        |
| Running z/OS UNIX System Services applications under z/OS batch . . . . .  | 416        |
| <b>Chapter 12. Cataloged procedures and REXX EXECs</b> . . . . .           | <b>419</b> |
| Tailoring cataloged procedures, REXX EXECs, and EXECs . . . . .            | 421        |
| Data sets used . . . . .   | 424        |
| Description of data sets used . . . . .                                    | 424        |
| Examples using cataloged procedures. . . . .                               | 431        |
| Other z/OS XL C utilities . . . . .  | 431        |
| Using the old syntax for CC. . . . .                                       | 431        |
| Using CMOD . . . . .   | 432        |

|   |     |
|---|-----|
| <b>Chapter 13. Object library utility</b>                   | 437 |
| Creating an object library under z/OS batch                 | 437 |
| Creating an object library under TSO                        | 438 |
| Object library utility map                                  | 440 |
| <b>Chapter 14. Filter utility</b>                           | 449 |
| CXXFILT options   | 450 |
| SYMMAP   NOSYMMAP   | 450 |
| SIDEBYSIDE   NOSIDEBYSIDE                                   | 450 |
| WIDTH(width)   NOWIDTH                                      | 450 |
| REGULARNAME   NOREGULARNAME                                 | 450 |
| CLASSNAME   NOCLASSNAME                                     | 451 |
| SPECIALNAME   NOSPECIALNAME                                 | 451 |
| Unknown type of name  | 451 |
| Under z/OS batch  | 451 |
| Under TSO   | 452 |
| <b>Chapter 15. DSECT conversion utility</b>                 | 455 |
| DSECT Utility options                                       | 455 |
| SECT  | 455 |
| BITF0XL   NOBITF0XL   | 456 |
| COMMENT   NOCOMMENT   | 457 |
| DECIMAL   NODECIMAL   | 457 |
| DEFSUB   NODEFSUB   | 458 |
| EQUATE   NOEQUATE   | 459 |
| HDRSKIP   NOHDRSKIP   | 461 |
| INDENT   NOINDENT   | 461 |
| LOCALE   NOLOCALE   | 461 |
| LOWERCASE   NOLOWERCASE                                     | 462 |
| LP64   NOLP64   | 462 |
| OPTFILE   NOOPTFILE   | 462 |
| PPCOND   NOPPCOND   | 462 |
| SEQUENCE   NOSEQUENCE                                       | 463 |
| UNIQUE   NOUNIQUE   | 463 |
| UNNAMED   NOUNNAMED   | 464 |
| OUTPUT  | 464 |
| RECFM   | 464 |
| LRECL   | 464 |
| BLKSIZE   | 464 |
| Generation of structures                                    | 464 |
| Under z/OS batch  | 467 |
| Under TSO   | 468 |
| <b>Chapter 16. Coded character set and locale utilities</b> | 469 |
| Coded character set conversion utilities                    | 469 |
| iconv utility   | 469 |
| genxlt utility  | 471 |
| localedef utility   | 473 |

---

**Part 5. z/OS UNIX System Services utilities** . . . . . 477

|   |     |
|---|-----|
| <b>Chapter 17. Archive and make utilities</b> | 479 |
| Archive libraries                             | 479 |
| Creating archive libraries                    | 479 |
| Creating makefiles                            | 480 |
| Makedepend utility                            | 480 |

|  |     |
|--|-----|
| <b>Chapter 18. BPXBATCH utility</b>  | 481 |
| BPXBATCH usage   | 481 |
| Parameter  | 482 |
| Usage notes  | 483 |
| Files  | 483 |
| <b>Chapter 19. as — Use the HLASM assembler to produce object files</b>              | 485 |
| Format   | 485 |
| Description  | 485 |
| Options  | 485 |
| <b>Chapter 20. c89 — Compiler invocation using host environment variables</b>        | 489 |
| Format   | 489 |
| Description  | 489 |
| Options  | 491 |
| Operands   | 502 |
| Environment variables  | 504 |
| Files  | 518 |
| Usage notes  | 518 |
| Localization   | 524 |
| Exit values  | 525 |
| Portability  | 525 |
| Related information  | 526 |
| <b>Chapter 21. xlc — Compiler invocation using a customizable configuration file</b> | 527 |
| Format   | 527 |
| Description  | 527 |
| Invocation commands  | 528 |
| Setting up the compilation environment   | 529 |
| Environment variables  | 530 |
| Setting up a configuration file  | 531 |
| Configuration file attributes  | 531 |
| Tailoring a configuration file   | 535 |
| Default configuration file   | 535 |
| Invoking the compiler  | 538 |
| Invoking the binder  | 538 |
| Supported options  | 538 |
| –q options syntax  | 538 |
| Flag options syntax  | 540 |
| Specifying compiler options  | 543 |
| Specifying compiler options on the command line                                      | 544 |
| Specifying flag options  | 545 |
| Specifying compiler options in a configuration file                                  | 545 |
| Specifying compiler options in your program source files                             | 545 |
| Specifying compiler options for architecture-specific 32-bit or 64-bit compilation   | 546 |

---

**Part 6. Appendixes** . . . . . 547

|  |     |
|--|-----|
| <b>Appendix A. Prelinking and linking z/OS XL C/C++ programs</b> | 549 |
| Restrictions on using the prelinker                              | 549 |
| Prelinking an application  | 549 |
| Using DD Statements for the standard data sets - prelinker       | 550 |
| Input to the prelinker   | 552 |
| Prelinker output   | 552 |

|   |            |
|---|------------|
| Mapping long names to short names . . . . .                               | 553        |
| Linking an application . . . . .  | 554        |
| Using DD statements for standard data sets—linkage editor . . . . .       | 554        |
| Input to the linkage editor . . . . .                                     | 555        |
| Output from the linkage editor . . . . .                                  | 556        |
| Link-editing multiple object modules . . . . .                            | 557        |
| Building DLLs . . . . .   | 558        |
| Linking your code . . . . .   | 559        |
| Using DLLs . . . . .  | 559        |
| Prelinking and linking an application under z/OS batch and TSO . . . . .  | 563        |
| z/OS Language Environment Prelinker Map . . . . .                         | 564        |
| Processing the prelinker automatic library call . . . . .                 | 569        |
| References to currently undefined symbols (external references) . . . . . | 569        |
| Prelinking and linking under z/OS batch . . . . .                         | 569        |
| Writing JCL for the prelinker and linkage editor . . . . .                | 571        |
| Secondary input to the linker . . . . .                                   | 572        |
| Using additional input object modules under z/OS batch . . . . .          | 573        |
| Under TSO . . . . .   | 573        |
| Using CPLINK . . . . .  | 576        |
| Using LINK . . . . .  | 578        |
| Prelinking and link-editing under the z/OS Shell . . . . .                | 580        |
| Using your JCL . . . . .  | 580        |
| Setting c89 to invoke the prelinker . . . . .                             | 582        |
| Using the c89 utility . . . . .   | 582        |
| Prelinker control statement processing . . . . .                          | 582        |
| IMPORT control statement . . . . .  | 583        |
| INCLUDE control statement . . . . .                                       | 583        |
| LIBRARY control statement . . . . .                                       | 584        |
| RENAME control statement . . . . .  | 585        |
| Reentrancy . . . . .  | 586        |
| Natural or constructed reentrancy . . . . .                               | 586        |
| Using the prelinker to make your program reentrant . . . . .              | 586        |
| Steps for generating a reentrant load module in C . . . . .               | 587        |
| Steps for generating a reentrant load module in C++ . . . . .             | 588        |
| Resolving multiple definitions of the same template function . . . . .    | 589        |
| External variables . . . . .  | 589        |
| <b>Appendix B. Prelinker and linkage editor options . . . . .</b>         | <b>591</b> |
| Prelinker options . . . . .   | 591        |
| DLLNAME(dll-name) . . . . .   | 591        |
| DUP   NODUP . . . . .   | 591        |
| DYNAM   NODYNAM . . . . .   | 591        |
| ER   NOER . . . . .   | 591        |
| MAP   NOMAP . . . . .   | 592        |
| MEMORY   NOMEMORY . . . . .   | 592        |
| NCAL   NONCAL . . . . .   | 592        |
| OMVS   NOOMVS . . . . .   | 592        |
| UPCASE   NOUPCASE . . . . .   | 593        |
| Linkage editor options . . . . .  | 593        |
| <b>Appendix C. Diagnosing problems . . . . .</b>                          | <b>595</b> |
| Problem checklist . . . . .   | 595        |
| When does the error occur? . . . . .                                      | 596        |
| Steps for problem diagnosis using optimization levels . . . . .           | 597        |
| Steps for diagnosing errors that occur at compile time . . . . .          | 598        |
| Steps for diagnosing errors that occur at IPA Link time . . . . .         | 599        |

|   |            |
|---|------------|
| The error occurs at bind time . . . . .   | 600        |
| The error occurs at prelink time . . . . .  | 600        |
| The error occurs at link time . . . . .   | 601        |
| Steps for diagnosing errors that occur at run time . . . . .                        | 601        |
| Steps for avoiding installation problems . . . . .                                  | 603        |
| <b>Appendix D. Calling the z/OS XL C/C++ compiler from assembler . . . . .</b>      | <b>605</b> |
| Example of using the assembler ATTACH macro (CCNUAAP) . . . . .                     | 607        |
| Example of JCL for the assembler ATTACH macro (CCNUAAQ) . . . . .                   | 609        |
| Example of using the assembler LINK macro (CCNUAAR) . . . . .                       | 610        |
| Example of JCL for the assembler LINK macro (CCNUAAS) . . . . .                     | 612        |
| Example of using the assembler CALL macro (CCNUAAT) . . . . .                       | 613        |
| Example of JCL for assembler CALL macro (CCNUAAU) . . . . .                         | 615        |
| <b>Appendix E. Layout of the Events file . . . . .</b>                              | <b>617</b> |
| Description of the FILEID field . . . . .   | 617        |
| Description of the FILEEND field . . . . .  | 618        |
| Description of the ERROR field . . . . .  | 618        |
| <b>Appendix F. Customizing default options for z/OS XL C/C++ compiler . . . . .</b> | <b>621</b> |
| <b>Appendix G. Accessibility . . . . .</b>  | <b>623</b> |
| Accessibility . . . . .   | 623        |
| Using assistive technologies . . . . .  | 623        |
| Keyboard navigation of the user interface. . . . .                                  | 623        |
| z/OS information . . . . .  | 623        |
| <b>Notices . . . . .</b>  | <b>625</b> |
| Programming interface information . . . . .   | 626        |
| Trademarks. . . . .   | 626        |
| Standards . . . . .   | 627        |
| <b>Glossary . . . . .</b>   | <b>629</b> |
| <b>Bibliography . . . . .</b>   | <b>657</b> |
| z/OS . . . . .  | 657        |
| z/OS XL C/C++ . . . . .   | 657        |
| z/OS Run-Time Library Extensions . . . . .  | 657        |
| Debug Tool . . . . .  | 657        |
| z/OS Language Environment . . . . .   | 658        |
| Assembler . . . . .   | 658        |
| COBOL . . . . .   | 658        |
| PL/I . . . . .  | 658        |
| VS FORTRAN. . . . .   | 658        |
| CICS Transaction Server for z/OS . . . . .  | 658        |
| DB2 . . . . .   | 658        |
| IMS/ESA. . . . .  | 659        |
| MVS . . . . .   | 659        |
| QMF . . . . .   | 659        |
| DFSMS . . . . .   | 659        |
| <b>INDEX . . . . .</b>  | <b>661</b> |

I





---

## About this document

This edition of *z/OS XL C/C++ User's Guide* is intended for users of the z/OS® or z/OS.e XL C/C++ compiler with the z/OS or z/OS.e Language Environment® product. It provides you with information about implementing (compiling, linking, and running) programs that are written in C and C++. It contains guidelines for preparing C and C++ programs to run on the z/OS or z/OS.e operating systems. References to z/OS in this document refer to both z/OS and z/OS.e.

Systems programmers who are interested in customizing compiler option defaults, should review Appendix F, “Customizing default options for z/OS XL C/C++ compiler,” on page 621. Information on customizing cataloged procedures, REXX EXECs, and EXECs is available in “Tailoring cataloged procedures, REXX EXECs, and EXECs” on page 421.

**Note:** As of z/OS V1R7, the z/OS C/C++ compiler has been rebranded to z/OS XL C/C++.

This document contains terminology, maintenance, and editorial changes. Technical changes or additions to the text and illustrations are indicated by a vertical line (|) to the left of the change.

You may notice changes in the style and structure of some of the contents in this document; for example, headings that use uppercase for the first letter of initial words only, and procedures that have a different look and format. The changes are ongoing improvements to the consistency and retrievability of information in our documents.

---

## Typographical conventions

The following table explains the typographical conventions used in this document.

Table 1. *Typographical conventions*

| Typeface       | Indicates  | Example   |
|----------------|--|---|
| <b>bold</b>    | Commands, executable names, compiler options and pragma directives that contain lower-case letters.  | The xlc utility provides two basic compiler invocation commands, <b>xlc</b> and <b>xlc (xlc++)</b> , along with several other compiler invocation commands to support various C/C++ language levels and compilation environments. |
| <i>italics</i> | Parameters or variables whose actual names or values are to be supplied by the user. Italics are also used to introduce new terms.                                   | Make sure that you update the <i>size</i> parameter if you return more than the <i>size</i> requested.  |
| monospace      | Programming keywords and library functions, compiler built-in functions, file and directory names, examples of program code, command strings, or user-defined names. | If one or two cases of a <code>switch</code> statement are typically executed much more frequently than other cases, break out those cases by handling them separately before the <code>switch</code> statement.                  |

---

## How to read syntax diagrams

This section describes how to read syntax diagrams. It defines syntax diagram symbols, items that may be contained within the diagrams (keywords, variables, delimiters, operators, fragment references, operands) and provides syntax examples that contain these items.

Syntax diagrams pictorially display the order and parts (options and arguments) that comprise a command statement. They are read from left to right and from top to bottom, following the main path of the horizontal line.

## Symbols

The following symbols may be displayed in syntax diagrams:

| Symbol | Definition   |
|--------|--|
| ▶—     | Indicates the beginning of the syntax diagram.                   |
| —▶     | Indicates that the syntax diagram is continued to the next line. |
| —▶     | Indicates that the syntax is continued from the previous line.   |
| —▶◀    | Indicates the end of the syntax diagram.                         |

## Syntax items

Syntax diagrams contain many different items. Syntax items include:

- **Keywords** - a command name or any other literal information.
- **Variables** - variables are italicized, appear in lowercase, and represent the name of values you can supply.
- **Delimiters** - delimiters indicate the start or end of keywords, variables, or operators. For example, a left parenthesis is a delimiter.
- **Operators** - operators include add (+), subtract (-), multiply (\*), divide (/), equal (=), and other mathematical operations that may need to be performed.
- **Fragment references** - a part of a syntax diagram, separated from the diagram to show greater detail.
- **Separators** - a separator separates keywords, variables or operators. For example, a comma (,) is a separator.

**Note:** If a syntax diagram shows a character that is not alphanumeric (for example, parentheses, periods, commas, equal signs, a blank space), enter the character as part of the syntax.

Keywords, variables, and operators may be displayed as required, optional, or default. Fragments, separators, and delimiters may be displayed as required or optional.

| Item type       | Definition   |
|-----------------|--|
| <b>Required</b> | Required items are displayed on the main path of the horizontal line.    |
| <b>Optional</b> | Optional items are displayed below the main path of the horizontal line. |
| <b>Default</b>  | Default items are displayed above the main path of the horizontal line.  |

## Syntax examples

The following table provides syntax examples.

Table 2. Syntax examples

| Item   | Syntax example       |
|--|----------------------|
| Required item.   |                      |
| Required items appear on the main path of the horizontal line. You must specify these items.   |                      |
| Required choice.   |                      |
| A required choice (two or more items) appears in a vertical stack on the main path of the horizontal line. You must choose one of the items in the stack.  |                      |
| Optional item.   |                      |
| Optional items appear below the main path of the horizontal line.  |                      |
| Optional choice.   |                      |
| An optional choice (two or more items) appears in a vertical stack below the main path of the horizontal line. You may choose one of the items in the stack.   |                      |
| Default.   |                      |
| Default items appear above the main path of the horizontal line. The remaining items (required or optional) appear on (required) or below (optional) the main path of the horizontal line. The following example displays a default with optional items. |                      |
| Variable.  |                      |
| Variables appear in lowercase italics. They represent names or values.   |                      |
| Repeatable item.   |                      |
| An arrow returning to the left above the main path of the horizontal line indicates an item that can be repeated.  |                      |
| A character within the arrow means you must separate repeated items with that character.   |                      |
| An arrow returning to the left above a group of repeatable items indicates that one of the items can be selected, or a single item can be repeated.  |                      |
| Fragment.  |                      |
| The <code>  fragment  </code> symbol indicates that a labelled group is described below the main syntax diagram. Syntax is occasionally broken into fragments if the inclusion of the fragment would overly complicate the main syntax diagram.          |                      |
|  | <b>fragment:</b><br> |

## z/OS XL C/C++ and related documents

This section summarizes the content of the z/OS XL C/C++ documents and shows where to find related information in other documents.

Table 3. z/OS XL C/C++ and related documents

| Document Title and Number                   | Key Sections/Chapters in the Document  |
|---|--|
| z/OS XL C/C++ Programming Guide, SC09-4765  | <p>Guidance information for:</p> <ul style="list-style-type: none"> <li>• XL C/C++ input and output</li> <li>• Debugging z/OS XL C programs that use input/output</li> <li>• Using linkage specifications in C++</li> <li>• Combining C and assembler</li> <li>• Creating and using DLLs</li> <li>• Using threads in z/OS UNIX<sup>®</sup> System Services applications</li> <li>• Reentrancy</li> <li>• Handling exceptions, error conditions, and signals</li> <li>• Performance optimization</li> <li>• Network communications under z/OS UNIX System Services</li> <li>• Interprocess communications using z/OS UNIX System Services</li> <li>• Structuring a program that uses C++ templates</li> <li>• Using environment variables</li> <li>• Using System Programming C facilities</li> <li>• Library functions for the System Programming C facilities</li> <li>• Using run-time user exits</li> <li>• Using the z/OS XL C multitasking facility</li> <li>• Using other IBM<sup>®</sup> products with z/OS XL C/C++ (CICS<sup>®</sup> Transaction Server for z/OS, CSP, DWS, DB2<sup>®</sup>, GDDM<sup>®</sup>, IMS<sup>™</sup>, ISPF, QMF<sup>™</sup>)</li> <li>• Internationalization: locales and character sets, code set conversion utilities, mapping variant characters</li> <li>• POSIX character set</li> <li>• Code point mappings</li> <li>• Locales supplied with z/OS XL C/C++</li> <li>• Charmap files supplied with z/OS XL C/C++</li> <li>• Examples of charmap and locale definition source files</li> <li>• Converting code from coded character set IBM-1047</li> <li>• Using built-in functions</li> <li>• Programming considerations for z/OS UNIX System Services C/C++</li> </ul> |
| z/OS XL C/C++ User's Guide, SC09-4767       | <p>Guidance information for:</p> <ul style="list-style-type: none"> <li>• z/OS XL C/C++ examples</li> <li>• Compiler options</li> <li>• Binder options and control statements</li> <li>• Specifying Language Environment run-time options</li> <li>• Compiling, IPA Linking, binding, and running z/OS XL C/C++ programs</li> <li>• Utilities (Object Library, CXXFILT, DSECT Conversion, Code Set and Locale, ar and make, BPXBATCH, c89, xlc)</li> <li>• Diagnosing problems</li> <li>• Cataloged procedures and REXX EXECs supplied by IBM</li> <li>• Customizing default options for the z/OS XL C/C++ compiler</li> </ul>   |
| z/OS XL C/C++ Language Reference, SC09-4815 | <p>Reference information for:</p> <ul style="list-style-type: none"> <li>• The C and C++ languages</li> <li>• Lexical elements of z/OS XL C and C++</li> <li>• Declarations, expressions, and operators</li> <li>• Implicit type conversions</li> <li>• Functions and statements</li> <li>• Preprocessor directives</li> <li>• C++ classes, class members, and friends</li> <li>• C++ overloading, special member functions, and inheritance</li> <li>• C++ templates and exception handling</li> <li>• z/OS XL C and C++ compatibility</li> </ul>   |

Table 3. z/OS XL C/C++ and related documents (continued)

| Document Title and Number   | Key Sections/Chapters in the Document  |
|---|--|
| <i>z/OS XL C/C++ Messages</i> , GC09-4819   | Provides error messages and return codes for the compiler, and its related application interface libraries and utilities. For the XL C/C++ run-time library messages, refer to <i>z/OS Language Environment Run-Time Messages</i> , SA22-7566. For the c89 and xlc utility messages, refer to <i>z/OS UNIX System Services Messages and Codes</i> , SA22-7807.   |
| <i>z/OS XL C/C++ Run-Time Library Reference</i> , SA22-7821   | Reference information for: <ul style="list-style-type: none"> <li>• header files</li> <li>• library functions</li> </ul>   |
| <i>z/OS C Curses</i> , SA22-7820  | Reference information for: <ul style="list-style-type: none"> <li>• Curses concepts</li> <li>• Key data types</li> <li>• General rules for characters, renditions, and window properties</li> <li>• General rules of operations and operating modes</li> <li>• Use of macros</li> <li>• Restrictions on block-mode terminals</li> <li>• Curses functional interface</li> <li>• Contents of headers</li> <li>• The terminfo database</li> </ul>   |
| <i>z/OS XL C/C++ Compiler and Run-Time Migration Guide for the Application Programmer</i> , GC09-4913 | Guidance and reference information for: <ul style="list-style-type: none"> <li>• Common migration questions</li> <li>• Application executable program compatibility</li> <li>• Source program compatibility</li> <li>• Input and output operations compatibility</li> <li>• Class library migration considerations</li> <li>• Changes between releases of z/OS</li> <li>• Pre-z/OS C and C++ compilers to current compiler migration</li> <li>• Other migration considerations</li> </ul>  |
| <i>Standard C++ Library Reference</i> , SC09-4949   | The documentation describes how to use the following three main components of the Standard C++ Library to write portable C/C++ code that complies with the ISO standards: <ul style="list-style-type: none"> <li>• ISO Standard C Library</li> <li>• ISO Standard C++ Library</li> <li>• Standard Template Library (C++)</li> </ul> <p>The ISO Standard C++ library consists of 51 required headers. These 51 C++ library headers (along with the additional 18 Standard C headers) constitute a hosted implementation of the C++ library. Of these 51 headers, 13 constitute the Standard Template Library, or STL.</p> |
| <i>C/C++ Legacy Class Libraries Reference</i> , SC09-7652   | Reference information for: <ul style="list-style-type: none"> <li>• UNIX System Laboratories (USL) I/O Stream Library</li> <li>• USL Complex Mathematics Library</li> </ul> <p>This reference is part of the Run-Time Library Extensions documentation.</p>  |
| <i>IBM Open Class Library Transition Guide</i> , SC09-4948  | The documentation explains the various options to application owners and users for migrating from the IBM Open Class <sup>®</sup> library to the Standard C++ Library.   |
| <i>z/OS Common Debug Architecture User's Guide</i> , SC09-7653  | This documentation is the user's guide for IBM's libddpi library. It includes: <ul style="list-style-type: none"> <li>• Overview of the architecture</li> <li>• Information on the order and purpose of API calls for model user applications and for accessing DWARF information</li> <li>• Information on using the Common Debug Architecture with C/C++ source</li> </ul> <p>This user's guide is part of the Run-Time Library Extensions documentation.</p>  |

Table 3. z/OS XL C/C++ and related documents (continued)

| Document Title and Number   | Key Sections/Chapters in the Document   |
|---|---|
| <i>z/OS Common Debug Architecture Library Reference</i> , SC09-7654                               | This documentation is the reference for IBM's libddpi library. It includes: <ul style="list-style-type: none"> <li>• General discussion of Common Debug Architecture</li> <li>• Description of APIs and data types related to stacks, processes, operating systems, machine state, storage, and formatting</li> </ul> <p>This reference is part of the Run-Time Library Extensions documentation.</p>   |
| <i>DWARF/ELF Extensions Library Reference</i> , SC09-7655   | This documentation is the reference for IBM's extensions to the libdwarf and libelf libraries. It includes information on: <ul style="list-style-type: none"> <li>• Consumer APIs</li> <li>• Producer APIs</li> </ul> <p>This reference is part of the Run-Time Library Extensions documentation.</p>   |
| Debug Tool documentation, available on the Debug Tool for z/OS library page on the World Wide Web | The documentation, which is available at <a href="http://www.ibm.com/software/awdtools/debugtool/library/">www.ibm.com/software/awdtools/debugtool/library/</a> , provides guidance and reference information for debugging programs, using Debug Tool in different environments, and language-specific information.  |
| APAR and BOOKS files (Shipped with Program materials)   | Partitioned data set CBC.SCCNDOC on the product tape contains the members, APAR and BOOKS, which provide additional information for using the z/OS XL C/C++ licensed program, including: <ul style="list-style-type: none"> <li>• Isolating reportable problems</li> <li>• Keywords</li> <li>• Preparing an Authorized Program Analysis Report (APAR)</li> <li>• Problem identification worksheet</li> <li>• Maintenance on z/OS</li> <li>• Late changes to z/OS XL C/C++ publications</li> </ul> |

**Note:** For complete and detailed information on linking and running with Language Environment and using the Language Environment run-time options, refer to *z/OS Language Environment Programming Guide*, SA22-7561. For complete and detailed information on using interlanguage calls, refer to *z/OS Language Environment Writing Interlanguage Communication Applications*, SA22-7563.

The following table lists the z/OS XL C/C++ and related documents. The table groups the documents according to the tasks they describe.

Table 4. Documents by task

| Tasks   | Documents   |
|---|---|
| Planning, preparing, and migrating to z/OS XL C/C++ | <ul style="list-style-type: none"> <li>• <i>z/OS XL C/C++ Compiler and Run-Time Migration Guide for the Application Programmer</i>, GC09-4913</li> <li>• <i>z/OS Language Environment Customization</i>, SA22-7564</li> <li>• <i>z/OS Language Environment Run-Time Application Migration Guide</i>, GA22-7565</li> <li>• <i>z/OS UNIX System Services Planning</i>, GA22-7800</li> <li>• <i>z/OS and z/OS.e Planning for Installation</i>, GA22-7504</li> </ul>      |
| Installing  | <ul style="list-style-type: none"> <li>• <i>z/OS Program Directory</i></li> <li>• <i>z/OS and z/OS.e Planning for Installation</i>, GA22-7504</li> <li>• <i>z/OS Language Environment Customization</i>, SA22-7564</li> </ul>   |
| Option customization                                | <ul style="list-style-type: none"> <li>• <i>z/OS XL C/C++ User's Guide</i>, SC09-4767</li> </ul>  |
| Coding programs                                     | <ul style="list-style-type: none"> <li>• <i>z/OS XL C/C++ Run-Time Library Reference</i>, SA22-7821</li> <li>• <i>z/OS XL C/C++ Language Reference</i>, SC09-4815</li> <li>• <i>z/OS XL C/C++ Programming Guide</i>, SC09-4765</li> <li>• <i>z/OS Language Environment Concepts Guide</i>, SA22-7567</li> <li>• <i>z/OS Language Environment Programming Guide</i>, SA22-7561</li> <li>• <i>z/OS Language Environment Programming Reference</i>, SA22-7562</li> </ul> |

Table 4. Documents by task (continued)

| Tasks  | Documents  |
|--|--|
| Coding and binding programs with interlanguage calls   | <ul style="list-style-type: none"> <li>• <i>z/OS XL C/C++ Programming Guide</i>, SC09-4765</li> <li>• <i>z/OS XL C/C++ Language Reference</i>, SC09-4815</li> <li>• <i>z/OS Language Environment Programming Guide</i>, SA22-7561</li> <li>• <i>z/OS Language Environment Writing Interlanguage Communication Applications</i>, SA22-7563</li> <li>• <i>z/OS MVS Program Management: User's Guide and Reference</i>, SA22-7643</li> <li>• <i>z/OS MVS Program Management: Advanced Facilities</i>, SA22-7644</li> </ul>  |
| Compiling, binding, and running programs   | <ul style="list-style-type: none"> <li>• <i>z/OS XL C/C++ User's Guide</i>, SC09-4767</li> <li>• <i>z/OS Language Environment Programming Guide</i>, SA22-7561</li> <li>• <i>z/OS Language Environment Debugging Guide</i>, GA22-7560</li> <li>• <i>z/OS MVS Program Management: User's Guide and Reference</i>, SA22-7643</li> <li>• <i>z/OS MVS Program Management: Advanced Facilities</i>, SA22-7644</li> </ul>  |
| Compiling and binding applications in the z/OS UNIX System Services (z/OS UNIX) environment      | <ul style="list-style-type: none"> <li>• <i>z/OS XL C/C++ User's Guide</i>, SC09-4767</li> <li>• <i>z/OS UNIX System Services User's Guide</i>, SA22-7801</li> <li>• <i>z/OS UNIX System Services Command Reference</i>, SA22-7802</li> <li>• <i>z/OS MVS Program Management: User's Guide and Reference</i>, SA22-7643</li> <li>• <i>z/OS MVS Program Management: Advanced Facilities</i>, SA22-7644</li> </ul>   |
| Debugging programs   | <ul style="list-style-type: none"> <li>• README file</li> <li>• <i>z/OS XL C/C++ User's Guide</i>, SC09-4767</li> <li>• <i>z/OS XL C/C++ Messages</i>, GC09-4819</li> <li>• <i>z/OS XL C/C++ Programming Guide</i>, SC09-4765</li> <li>• <i>z/OS Language Environment Programming Guide</i>, SA22-7561</li> <li>• <i>z/OS Language Environment Debugging Guide</i>, GA22-7560</li> <li>• <i>z/OS Language Environment Run-Time Messages</i>, SA22-7566</li> <li>• <i>z/OS UNIX System Services Messages and Codes</i>, SA22-7807</li> <li>• <i>z/OS UNIX System Services User's Guide</i>, SA22-7801</li> <li>• <i>z/OS UNIX System Services Command Reference</i>, SA22-7802</li> <li>• <i>z/OS UNIX System Services Programming Tools</i>, SA22-7805</li> <li>• Debug Tool documentation, available on the Debug Tool Library page on the World Wide Web (<a href="http://www.ibm.com/software/awdtools/debugtool/library/">www.ibm.com/software/awdtools/debugtool/library/</a>)</li> <li>• z/OS messages database, available on the z/OS Library page at <a href="http://www.ibm.com/servers/eserver/zseries/zos/bkserv/">www.ibm.com/servers/eserver/zseries/zos/bkserv/</a> through the LookAt Internet message search utility.</li> </ul> |
| Developing debuggers and profilers   | <ul style="list-style-type: none"> <li>• <i>z/OS Common Debug Architecture User's Guide</i>, SC09-7653</li> <li>• <i>z/OS Common Debug Architecture Library Reference</i>, SC09-7654</li> <li>• <i>DWARF/ELF Extensions Library Reference</i>, SC09-7655</li> </ul>  |
| Packaging XL C/C++ applications  | <ul style="list-style-type: none"> <li>• <i>z/OS XL C/C++ Programming Guide</i>, SC09-4765</li> <li>• <i>z/OS XL C/C++ User's Guide</i>, SC09-4767</li> </ul>  |
| Using shells and utilities in the z/OS UNIX System Services environment                          | <ul style="list-style-type: none"> <li>• <i>z/OS XL C/C++ User's Guide</i>, SC09-4767</li> <li>• <i>z/OS UNIX System Services Command Reference</i>, SA22-7802</li> <li>• <i>z/OS UNIX System Services Messages and Codes</i>, SA22-7807</li> </ul>  |
| Using sockets library functions in the z/OS UNIX System Services environment                     | <ul style="list-style-type: none"> <li>• <i>z/OS XL C/C++ Run-Time Library Reference</i>, SA22-7821</li> </ul>   |
| Using the ISO Standard C++ Library to write portable C/C++ code that complies with ISO standards | <ul style="list-style-type: none"> <li>• <i>Standard C++ Library Reference</i>, SC09-4949</li> </ul>   |
| Migrating from the IBM Open Class Library to the Standard C++ Library                            | <ul style="list-style-type: none"> <li>• <i>IBM Open Class Library Transition Guide</i>, SC09-4948</li> </ul>  |



Table 4. Documents by task (continued)

| Tasks  | Documents  |
|--|--|
| Porting a z/OS UNIX System Services application to z/OS                          | <ul style="list-style-type: none"> <li>• <i>z/OS UNIX System Services Porting Guide</i><br/>This guide contains useful information about supported header files and C functions, sockets in z/OS UNIX System Services, process management, compiler optimization tips, and suggestions for improving the application's performance after it has been ported. The <i>Porting Guide</i> is available as a PDF file which you can download, or as web pages which you can browse, at the following web address: <a href="http://www.ibm.com/servers/eserver/zseries/zos/unix/bpxa1por.html">www.ibm.com/servers/eserver/zseries/zos/unix/bpxa1por.html</a></li> </ul> |
| Working in the z/OS UNIX System Services Parallel Environment                    | <ul style="list-style-type: none"> <li>• <i>z/OS UNIX System Services Parallel Environment: Operation and Use</i>, SA22-7810</li> <li>• <i>z/OS UNIX System Services Parallel Environment: MPI Programming and Subroutine Reference</i>, SA22-7812</li> </ul>  |
| Performing diagnosis and submitting an Authorized Program Analysis Report (APAR) | <ul style="list-style-type: none"> <li>• <i>z/OS XL C/C++ User's Guide</i>, SC09-4767</li> <li>• CBC.SCCND0C(APAR) on z/OS XL C/C++ product tape</li> </ul>  |
| Tuning Large C/C++ Applications on OS/390® UNIX System Services                  | <ul style="list-style-type: none"> <li>• IBM Redbook called <i>Tuning Large C/C++ Applications on OS/390 UNIX System Services</i>, which is available at: <a href="http://www.redbooks.ibm.com/abstracts/sg245606.html">www.redbooks.ibm.com/abstracts/sg245606.html</a></li> </ul>  |
| C/C++ Applications on z/OS and OS/390 UNIX                                       | <ul style="list-style-type: none"> <li>• IBM Redbook called <i>C/C++ Applications on z/OS and OS/390 UNIX</i>, which is available at: <a href="http://www.redbooks.ibm.com/abstracts/sg245992.html">www.redbooks.ibm.com/abstracts/sg245992.html</a></li> </ul>  |
| Performance considerations for XPLINK  | <ul style="list-style-type: none"> <li>• IBM Redbook called <i>XPLink: OS/390 Extra Performance Linkage</i>, which is available at: <a href="http://www.redbooks.ibm.com/abstracts/sg245991.html">www.redbooks.ibm.com/abstracts/sg245991.html</a></li> </ul>  |

**Note:** For information on using the prelinker, see Appendix A, "Prelinking and linking z/OS XL C/C++ programs," on page 549.

## Softcopy documents

The z/OS XL C/C++ publications are supplied in PDF and BookMaster® formats on the following CD: *z/OS Collection*, SK3T-4269. They are also available at [www.ibm.com/software/awdtools/czos/library/](http://www.ibm.com/software/awdtools/czos/library/).

To read a PDF file, use the Adobe Reader. If you do not have the Adobe Reader, you can download it from the Adobe Web site at [www.adobe.com](http://www.adobe.com).

You can also browse the documents on the World Wide Web by visiting the z/OS library at [www.ibm.com/servers/eserver/zseries/zos/bkserv/](http://www.ibm.com/servers/eserver/zseries/zos/bkserv/).

**Note:** For further information on viewing and printing softcopy documents and using BookManager®, see *z/OS Information Roadmap*.

## Softcopy examples

Most of the larger examples in the following documents are available in machine-readable form:

- *z/OS XL C/C++ Language Reference*, SC09-4815
- *z/OS XL C/C++ User's Guide*, SC09-4767
- *z/OS XL C/C++ Programming Guide*, SC09-4765



In the following documents, a label on an example indicates that the example is distributed as a softcopy file:

- *z/OS XL C/C++ Language Reference*, SC09-4815
- *z/OS XL C/C++ Programming Guide*, SC09-4765
- *z/OS XL C/C++ User's Guide*, SC09-4767

The label is the name of a member in the CBC.SCCNSAM data set. The labels begin with the form CCN or CLB. Examples labelled as CLB appear only in the *z/OS XL C/C++ User's Guide*, while examples labelled as CCN appear in all three documents, and are further distinguished by *x* following CCN, where *x* represents one of the following:

- R and X refer to *z/OS XL C/C++ Language Reference*, SC09-4815
- G refers to *z/OS XL C/C++ Programming Guide*, SC09-4765
- U refers to *z/OS XL C/C++ User's Guide*, SC09-4767

---

## **z/OS XL C/C++ on the World Wide Web**

Additional information on z/OS XL C/C++ is available on the World Wide Web on the z/OS XL C/C++ home page at: [www.ibm.com/software/awdtools/czos/](http://www.ibm.com/software/awdtools/czos/)

This page contains late-breaking information about the z/OS XL C/C++ product, including the compiler, the C/C++ libraries, and utilities. There are links to other useful information, such as the z/OS XL C/C++ information library and the libraries of other z/OS elements that are available on the Web. The z/OS XL C/C++ home page also contains links to other related Web sites.

## **Where to find more information**

Please see *z/OS Information Roadmap* for an overview of the documentation associated with z/OS, including the documentation available for z/OS Language Environment.

### **Using LookAt to look up message explanations**

LookAt is an online facility that lets you look up explanations for most of the IBM messages you encounter, as well as for some system abends and codes. Using LookAt to find information is faster than a conventional search because in most cases LookAt goes directly to the message explanation.

You can use LookAt from these locations to find IBM message explanations for z/OS elements and features, z/VM<sup>®</sup>, VSE/ESA<sup>™</sup>, and Clusters for AIX<sup>®</sup> and Linux<sup>™</sup>:

- The Internet. You can access IBM message explanations directly from the LookAt Web site at [www.ibm.com/servers/eserver/zseries/zos/bkserv/lookat/](http://www.ibm.com/servers/eserver/zseries/zos/bkserv/lookat/).
- Your z/OS TSO/E host system. You can install code on your z/OS or z/OS.e systems to access IBM message explanations using LookAt from a TSO/E command line (for example: TSO/E prompt, ISPF, or z/OS UNIX System Services).
- Your Microsoft<sup>®</sup> Windows<sup>®</sup> workstation. You can install LookAt directly from the *z/OS Collection* (SK3T-4269) or the *z/OS and Software Products DVD Collection* (SK3T-4271) and use it from the resulting Windows graphical user interface (GUI). The command prompt (also known as the DOS > command line) version can still be used from the directory in which you install the Windows version of LookAt.
- Your wireless handheld device. You can use the LookAt Mobile Edition from [www.ibm.com/servers/eserver/zseries/zos/bkserv/lookat/lookatm.html](http://www.ibm.com/servers/eserver/zseries/zos/bkserv/lookat/lookatm.html) with a

handheld device that has wireless access and an Internet browser (for example: Internet Explorer for Pocket PCs, Blazer or Eudora for Palm OS, or Opera for Linux handheld devices).

You can obtain code to install LookAt on your host system or Microsoft Windows workstation from:

- A CD-ROM in the *z/OS Collection* (SK3T-4269).
- The *z/OS and Software Products DVD Collection* (SK3T-4271).
- The LookAt Web site (click **Download** and then select the platform, release, collection, and location that suit your needs). More information is available in the LOOKAT.ME files available during the download process.

### Using IBM Health Checker for z/OS

IBM Health Checker for z/OS is a z/OS component that installations can use to gather information about their system environment and system parameters to help identify potential configuration problems before they impact availability or cause outages. Individual products, z/OS components, or ISV software can provide checks that take advantage of the IBM Health Checker for z/OS framework. This book refers to checks or messages associated with this component.

For additional information about checks and about IBM Health Checker for z/OS, see *IBM Health Checker for z/OS: User's Guide*. Starting with z/OS V1R4, z/OS users can obtain the IBM Health Checker for z/OS from the z/OS Downloads page at [www.ibm.com/servers/eserver/zseries/zos/downloads/](http://www.ibm.com/servers/eserver/zseries/zos/downloads/).

SDSF also provides functions to simplify the management of checks. See *z/OS SDSF Operation and Customization* for additional information.

### Information updates on the web

For the latest information updates that have been provided in PTF cover letters and Documentation APARs for z/OS and z/OS.e, see the online document at:

[publibz.boulder.ibm.com/cgi-bin/bookmgr\\_0S390/BOOKS/ZIDOCMST/CCONTENTS](http://publibz.boulder.ibm.com/cgi-bin/bookmgr_0S390/BOOKS/ZIDOCMST/CCONTENTS)

This document is updated weekly and lists documentation changes before they are incorporated into z/OS publications.

---

## Technical support

Additional technical support is available from the z/OS XL C/C++ Support page. This page provides a portal with search capabilities to a large selection of technical support FAQs and other support documents. You can find the z/OS XL C/C++ Support page on the Web at:

[www.ibm.com/software/awdtools/czos/support](http://www.ibm.com/software/awdtools/czos/support)

If you cannot find what you need, you can e-mail:

[compinfo@ca.ibm.com](mailto:compinfo@ca.ibm.com)

For the latest information about z/OS XL C/C++, visit the product information site at:

[www.ibm.com/software/awdtools/czos/](http://www.ibm.com/software/awdtools/czos/)

---

## How to send your comments

Your feedback is important in helping to provide accurate and high-quality information. If you have any comments about this document or any other z/OS XL C/C++ documentation, send your comments by e-mail to:

`compinfo@ca.ibm.com`

Be sure to include the name of the document, the part number of the document, the version of, and, if applicable, the specific location of the text you are commenting on (for example, a page number or table number).



---

## Part 1. Introduction

This part discusses introductory concepts for z/OS XL C/C++. Specifically, it discusses the following:

- Chapter 1, “About IBM z/OS XL C/C+,” on page 3
- “About prelinking, linking, and binding” on page 11



---

## Chapter 1. About IBM z/OS XL C/C++

The XL C/C++ feature of the IBM z/OS licensed program provides support for C and C++ application development on the z/OS platform.

z/OS XL C/C++ includes:

- A C compiler (referred to as the z/OS XL C compiler)
- A C++ compiler (referred to as the z/OS XL C++ compiler)
- Performance Analyzer host component, which supports the IBM C/C++ Productivity Tools for OS/390 product
- A set of utilities for C/C++ application development

### Notes:

1. The Run-Time Library Extensions base element was introduced in z/OS V1R5. It includes the Common Debug Architecture (CDA) Libraries, the c89 utility, and, as of z/OS V1R6, the xlc utility. The Common Debug Architecture provides a consistent and common format for debugging information across the various languages and operating systems that are supported on the IBM System z™ platform. Run-Time Library Extensions also includes legacy libraries to support existing programs. These are the UNIX System Laboratories (USL) I/O Stream Library, USL Complex Mathematics Library, and IBM Open Class DLLs. Application development using the IBM Open Class Library is not supported.
2. The Standard C++ Library is included with Language Environment.
3. The z/OS XL C/C++ compiler works with the mainframe interactive Debug Tool product.

IBM offers the C and C++ compilers on other platforms, such as the AIX, Linux, OS/400®, and z/VM operating systems. The C compiler is also available on the VSE/ESA platform.

---

## Changes for z/OS V1R8

z/OS XL C/C++ has made the following performance and usability enhancements for the z/OS V1R8 release:

### **z/OS XL C++ support for C99 (ISO/IEC 9899:1999) standard features**

z/OS V1R8 XL C++ supports the following set of C99 features:

- restrict qualifier
- valid universal character name ranges
- \_\_func\_\_ identifier for debugging assistance

### **z/OS XL C++ GNU enablement**

z/OS V1R8 XL C++ supports the #include\_next directive.

### **New compiler options**

z/OS V1R8 XL C/C++ introduces the following new compiler options:

- HGPR
- HOT
- SPLITLIST

### **New compiler suboptions**

z/OS V1R8 XL C/C++ introduces the following new compiler suboptions:

- LANGLVL(C99\_\_FUNC\_\_) (C++ only)

- TARGET(zOSV1R8)

### **Stabilization of the prelinker**

The prelinker was designed to process long names and support constructed reentrancy in earlier versions of the C compiler on the MVS™ and OS/390 operating systems. The prelinker, shipped with z/OS Language Environment, provides output that is compatible with the linkage editor that is shipped with the binder. The binder is designed to include the functions of the prelinker, the linkage editor, the loader, and a number of APIs to manipulate the program object. Its functionality provides a high level of compatibility with the prelinker and linkage editor, but provides additional functionality in some areas. IBM has stabilized the prelinker. Further enhancements will not be made to the prelinker. IBM recommends that you use the binder instead of the prelinker and linker, since only the binder will continue to be enhanced in future releases.

### **GONUMBER supports 64-bit applications**

The GONUMBER compiler option generates line number tables for both 31-bit and 64-bit applications.

### **Integrated CICS translator support**

Integrated CICS translation is supported for use with CICS Transaction Server for z/OS V3R1 and above. The integrated CICS translator enables users to embed CICS statements in C/C++ source and pass them through the compiler without the need for an explicit preprocessing step. This permits a more seamless operation of C/C++ within the CICS environment.

### **Storage limitations removed when optimizing complex applications using IPA**

The IPA optimizer is running in the 64-bit address space and no longer exhibits the storage limitations that restricted the use of the IPA optimizer during previous releases.

### **as command for High Level Assembler (HLASM) invocation**

The **as** command enables the user to process assembler source files and invoke the HLASM assembler to produce object files.

For z/OS V1R8, Language Environment provides the following:

#### **I/O changes** The z/OS XL C/C++ run-time library:

- Is enhanced to provide support for VSAM data sets with extended addressability. This support is for key-sequenced (KSDS), entry-sequenced (ESDS), and relative-record data sets (RRDS).

For more information, see *z/OS XL C/C++ Programming Guide*.

- Provides full support of QSAM (opened with NOSEEK in C/C++) for large-format sequential DASD data sets that were introduced by DFSMSdfp™ in z/OS V1R7, removing the constraint of 65535 tracks per volume for sequential data sets.

For more information, see *z/OS XL C/C++ Programming Guide*.

- Provides enhancements to the C run-time library functions `fgetpos()`, `fsetpos()`, and `fseek()`. This is intended to generally improve the performance of repositioning operations within multivolume data sets.

For more information, see *z/OS XL C/C++ Programming Guide*.

**Migration aid** The capability of the STORAGE run-time option has been expanded



to include CLEAR as an acceptable value for the third suboption. This new value causes the unused portion of the initial stack segment to be cleared to binary zeroes, just prior to invoking the main procedure, as it is done by the pre-Language Environment PL/I run-time library. This support was rolled back to z/OS V1R4 with APAR PK02614.

For more information, see *z/OS Language Environment Customization* and *z/OS Language Environment Programming Reference*.

#### **Application enablement**

The z/OS XL C/C++ run-time library is enhanced to provide the `flockfile()` family of common UNIX functions, as found within the SUSV3 standards.

For more information, see *z/OS XL C/C++ Run-Time Library Reference*.

#### **Language Environment-conforming assembler routines in CICS**

Customer Information Control System (CICS) Transaction Server for z/OS V3R1 now supports Language Environment-conforming assembler MAIN routines. This support was rolled back to z/OS V1R4 with documentation APAR PK02368.

For more information, see *z/OS Language Environment Programming Guide*.

#### **XPLINK**

Language Environment provides a tracing capability that can be customized on or off to trace the transitions between upward (non-XPLINK) and downward (XPLINK) growing stacks and more easily diagnose the performance bottlenecks in the mixed XPLINK/non-XPLINK applications. This support is controlled by the TRACE run-time option.

For more information, see *z/OS Language Environment Customization*, *z/OS Language Environment Programming Reference*, and *z/OS Language Environment Debugging Guide*.

#### **Callable services**

Language Environment provides support for:

- A new service CEE3PR2, an enhancement to CEE3PRM, supports longer parameter lists.
- A new service CEE3AB2, an enhancement to CEE3ABD, supports the addition of a reason code to the ABEND. Both CEE3AB2 and CEE3ABD now allow for more control of diagnostic information collection.
- A new service, CEE3INF, provides current Language Environment information about the enclave.
- A new service, CEEENV, allows for querying, setting, and deleting of environment variables.

For more information, see *z/OS Language Environment Programming Reference*.

#### **Reliability, availability, and serviceability**

Language Environment is enhanced to provide the following:

- Displaying source line numbers in the AMODE 64 virtual Language Environment dump (CEEDUMP) traceback for C/C++ applications.

- Providing a way for the user to instruct Language Environment to capture an IPCS readable dump when no SYSMDUMP DD card is available.

For more information, see *z/OS Language Environment Debugging Guide*.

#### **Additional Euro and locale support**

Language Environment provides locale support for the Euro currency symbol for countries that have recently joined the European Union. This function is also available with APAR PQ99282 for z/OS V1R4 and higher.

For more information, see *z/OS XL C/C++ Programming Guide*.

#### **Removal of msys for Setup for Language Environment**

Support for msys for Setup for Language Environment is removed.

---

## **The XL C/C++ compilers**

The following sections describe the C and C++ languages and the z/OS XL C/C++ compilers.

### **The C language**

The C language is a general purpose, versatile, and functional programming language that allows a programmer to create applications quickly and easily. C provides high-level control statements and data types as do other structured programming languages. It also provides many of the benefits of a low-level language.

### **The C++ language**

The C++ language is based on the C language and includes all of the advantages of C listed above. In addition, C++ also supports object-oriented concepts, generic types or templates, and an extensive library. For a detailed description of the differences between z/OS XL C++ and z/OS XL C, refer to *z/OS XL C/C++ Language Reference*.

The C++ language introduces classes, which are user-defined data types that may contain data definitions and function definitions. You can use classes from established class libraries, develop your own classes, or derive new classes from existing classes by adding data descriptions and functions. New classes can inherit properties from one or more classes. Not only do classes describe the data types and functions available, but they can also hide (encapsulate) the implementation details from user programs. An object is an instance of a class.

The C++ language also provides templates and other features that include access control to data and functions, and better type checking and exception handling. It also supports polymorphism and the overloading of operators.

## **Common features of the z/OS XL C and XL C++ compilers**

The XL C and XL C++ compilers, when used with z/OS Language Environment, offer many features to increase your productivity and improve program execution times:

- Optimization support:
  - Extra Performance Linkage (XPLINK) function calling convention, which has the potential for a significant performance increase when used in an

environment of frequent calls between small functions. XPLINK makes subroutine calls more efficient by removing non-essential instructions from the main path.

- Algorithms to take advantage of the zSeries® architecture to achieve improved optimization and memory usage through the OPTIMIZE and IPA compiler options.
- The OPTIMIZE compiler option, which instructs the compiler to optimize the machine instructions it generates to produce faster-running object code, which improves application performance at run time.
- Interprocedural Analysis (IPA), to perform optimizations across procedural and compilation unit boundaries, thereby optimizing application performance at run time.
- Additional optimization capabilities are available with the INLINE compiler option.

- DLLs (dynamic link libraries) to share parts among applications or parts of applications, and dynamically link to exported variables and functions at run time. DLLs allow a function reference or a variable reference in one executable to use a definition located in another executable at run time.

You can use DLLs to split applications into smaller modules and improve system memory usage. DLLs also offer more flexibility for building, packaging, and redistributing applications.

- Full program reentrancy

With reentrancy, many users can simultaneously run a program. A reentrant program uses less storage if it is stored in the Link Pack Area (LPA) or the Extended Link Pack Area (ELPA) and simultaneously run by multiple users. It also reduces processor I/O when the program starts up, and improves program performance by reducing the transfer of data to auxiliary storage. z/OS XL C programmers can design programs that are naturally reentrant. For those programs that are not naturally reentrant, z/OS XL C programmers can use constructed reentrancy. To do this, compile programs with the RENT option and use the program management binder supplied with z/OS or the z/OS Language Environment prelinker and program management binder. The z/OS XL C++ compiler always uses the constructed reentrancy algorithms.

- Locale-based internationalization support derived from *IEEE POSIX 1003.2-1992* standard. Also derived from *X/Open CAE Specification, System Interface Definitions, Issue 4* and *Issue 4 Version 2*. This allows you to use locales to specify language/country characteristics for their applications.
- The ability to call and be called by other languages such as assembler, COBOL, PL/1, compiled Java™, and Fortran, to enable you to integrate z/OS XL C/C++ code with existing applications.
- Exploitation of z/OS and z/OS UNIX System Services technology.  
z/OS UNIX System Services is the IBM implementation of the open operating system environment, as defined in the XPG4 and POSIX standards.
- Support for the following standards at the system level:
  - A subset of *ISO/IEC 9899:1999*
  - *ISO/IEC 9945-1:1990 (POSIX-1)/IEEE POSIX 1003.1-1990*
  - A subset of *IEEE POSIX 1003.1a, Draft 6, July 1991*
  - *IEEE Portable Operating System Interface (POSIX) Part 2, P1003.2*
  - A subset of *IEEE POSIX 1003.4a, Draft 6, February 1992* (the IEEE POSIX committee has renumbered POSIX.4a to POSIX.1c)
  - *X/Open CAE Specification, System Interfaces and Headers, Issue 4 Version 2*

- A subset of *IEEE 754-1985 (R1990) IEEE Standard for Binary Floating-Point Arithmetic (ANSI)*, as applicable to the IBM System z environment.
- *X/Open CAE Specification, Networking Services, Issue 4*
- Support for the Euro currency

## z/OS XL C compiler-specific features

In addition to the features common to z/OS XL C and XL C++, the z/OS XL C compiler provides you with the following capabilities:

- The ability to write portable code that supports the following standards:
  - *ISO/IEC 9899:1999*
  - *ANSI/ISO 9899:1990[1992] (formerly ANSI X3.159-1989 C)*
  - *X/Open Specification Programming Languages, Issue 3, Common Usage C*
  - *FIPS-160*
- System programming capabilities, which allow you to use z/OS XL C in place of assembler
- Extensions of the standard definitions of the C language to provide you with support for the z/OS environment, such as fixed-point (packed) decimal data support

## z/OS XL C++ compiler-specific features

In addition to the features common to z/OS XL C and XL C++, the z/OS XL C++ compiler supports the *Programming languages - C++ (ISO/IEC 14882:1998)* standard. Also, it further conforms to the *Programming languages - C++ (ISO/IEC 14882:2003(E))* standard, which incorporates the latest Technical Corrigendum 1.

---

## Class libraries

z/OS V1R8 XL C/C++ uses the following thread-safe class libraries:

- Standard C++ Library, including the Standard Template Library (STL), and other library features of *Programming languages - C++ (ISO/IEC 14882:1998)* and *Programming languages - C++ (ISO/IEC 14882:2003(E))*
- UNIX System Laboratories (USL) C++ Language System Release I/O Stream and Complex Mathematics Class Libraries

**Note:** As of z/OS V1R5, all application development using the C/C++ IBM Open Class Library (Application Support Class and Collection Class Libraries) is not supported. Run-time support for the execution of existing applications, which use the IBM Open Class, is provided with z/OS V1R8 but is planned to be removed in a future release. For additional information, see *IBM Open Class Library Transition Guide*.

For new code and enhancements to existing applications, the Standard C++ Library should be used. The Standard C++ Library includes the following:

- Stream classes for performing input and output (I/O) operations
- The Standard C++ Complex Mathematics Library for manipulating complex numbers
- The Standard Template Library (STL) which is composed of C++ template-based algorithms, container classes, iterators, localization objects, and the string class

---

## Utilities

The z/OS XL C/C++ compilers provide the following utilities:

- The xlc utility to invoke the compiler using a customizable configuration file.
- The c89 utility to invoke the compiler using host environment variables.
- The CXXFILT utility to map z/OS XL C++ mangled names to their original function names.
- The DSECT conversion utility to convert descriptive assembler DSECTs into z/OS XL C/C++ data structures.
- The makedepend utility to derive all dependencies in the source code and write these into the makefile. The **make** command will determine which source files to recompile, whenever a dependency has changed. This frees the user from manually monitoring such changes in the source code.

z/OS Language Environment provides the following utilities:

- The object library utility (C370LIB; also known as EDCALIAS) to update partitioned data set (PDS and PDSE) libraries of object modules. The object library utility supports XPLINK, IPA, and LP64 compiled objects.

**Note:** In this book, references to *Partitioned Data Set* (PDS) include both the PDS and *Partitioned Data Set Extended* (PDSE) physical formats, unless stated otherwise.

- The prelinker which combines object modules that comprise a z/OS XL C/C++ application to produce a single object module. The prelinker supports only object and extended object format input files, and does not support GOFF.

**Note:** IBM has stabilized the prelinker. Further enhancements will not be made to the prelinker utility. IBM recommends that you use the binder instead of the prelinker and linker.

---

## dbx

You can use the **dbx** shell command to debug programs, as described in *z/OS UNIX System Services Programming Tools* and *z/OS UNIX System Services Command Reference*.

Refer to [www.ibm.com/servers/eserver/zseries/zos/unix/bpxa1dbx.html](http://www.ibm.com/servers/eserver/zseries/zos/unix/bpxa1dbx.html) for further information on dbx.

---

## z/OS Language Environment

z/OS XL C/C++ exploits the C/C++ run-time environment and library of run-time services available with z/OS Language Environment (formerly OS/390 Language Environment, Language Environment for MVS & VM, Language Environment/370 and LE/370).

z/OS Language Environment consists of four language-specific run-time libraries, and Base Routines and Common Services, as shown below. z/OS Language Environment establishes a common run-time environment and common run-time services for language products, user programs, and other products.

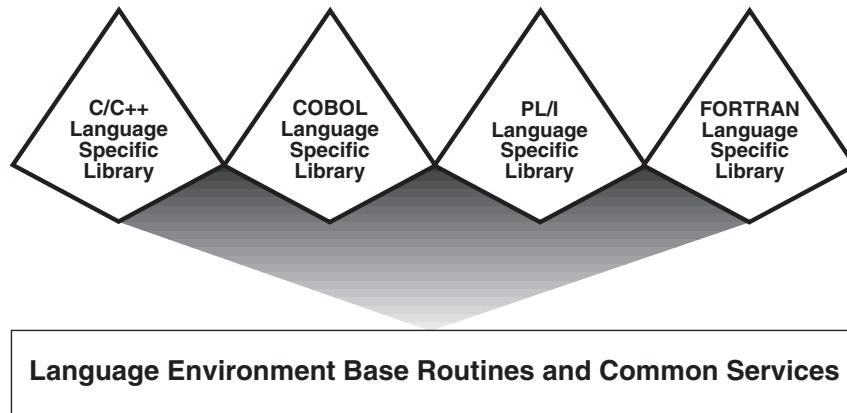

Figure 1. Libraries in z/OS Language Environment

The common execution environment is composed of data items and services that are included in library routines available to an application that runs in the environment. z/OS Language Environment provides a variety of services:

- Services that satisfy basic requirements common to most applications. These include support for the initialization and termination of applications, allocation of storage, interlanguage communication (ILC), and condition handling.
- Extended services that are often needed by applications. z/OS XL C/C++ contains these functions within a library of callable routines, and includes interfaces to operating system functions and a variety of other commonly used functions.
- Run-time options that help in the execution, performance, and diagnosis of your application.
- Access to operating system services; z/OS UNIX System Services is available to you or your program through the z/OS XL C/C++ language bindings.
- Access to language-specific library routines, such as the z/OS XL C/C++ library functions.

**Note:** The z/OS Language Environment run-time option TRAP(ON) should be set when using z/OS XL C/C++. Refer to *z/OS Language Environment Programming Reference* for details on the z/OS Language Environment run-time options.

## z/OS Language Environment downward compatibility

z/OS Language Environment provides downward compatibility support. Assuming that you have met the required programming guidelines and restrictions, described in *z/OS Language Environment Programming Guide*, this support enables you to develop applications on higher release levels of z/OS for use on platforms that are running lower release levels of z/OS. In XL C and XL C++, downward compatibility support is provided through the XL C/C++ TARGET compiler option. See “TARGET” on page 198 for details on this compiler option.

For example, a company may use z/OS V1R8 with Language Environment on a development system where applications are coded, link-edited, and tested, while using any supported lower release of z/OS Language Environment on their production systems where the finished application modules are used.

Downward compatibility support is not the roll-back of new function to prior releases of the operating system. Applications developed that exploit the downward



compatibility support must not use any Language Environment function that is unavailable on the lower release of z/OS where the application will be used.

The downward compatibility support includes toleration PTFs for lower releases of z/OS to assist in diagnosing applications that do not meet the programming requirements for this support. (Specific PTF numbers can be found in the PSP buckets.)

The diagnosis assistance that will be provided by the toleration PTFs includes detection of an unsupported program object format. If the program object format is at a level which is not supported by the target deployment system, then the deployment system will produce an abend when trying to load the application program. The abend will indicate that DFSMS was unable to find or load the application program. Correcting this problem does not require the installation of any toleration PTFs. Instead, you will need to recreate the program object that is compatible with the older deployment system.

The downward compatibility support that is provided by z/OS Language Environment and by the toleration PTFs does not change upward compatibility. That is, applications coded and link-edited with one release of z/OS Language Environment will continue to run on later releases of z/OS Language Environment without the need to recompile or re-link edit the application, independent of the downward compatibility support.

The current z/OS level header files and SYSLIB can be used (the user no longer has to copy header files and SYSLIB data sets from the deployment release).

**Note:** As of z/OS V1R3, the executables produced with the binder's COMPAT=CURRENT setting will not run on lower levels of z/OS. You will have to explicitly override to a particular program object level, or use the COMPAT=MIN setting introduced in z/OS V1R3.

---

## About prelinking, linking, and binding

When describing the process to build an application, this document refers to the *bind step*.

Normally, the program management binder is used to perform the bind step. However, in many cases the prelink and link steps can be used in place of the bind step. When they cannot be substituted, and the program management binder alone must be used, it will be stated.

The terms *bind* and *link* have multiple meanings.

- With respect to building an application:

In both instances, the program management binder is performing the actual processing of converting the object file(s) into the application executable module. Object files with longname symbols, reentrant writable static symbols, and DLL-style function calls require additional processing to build global data for the application.

The term *link* refers to the case where the binder does not perform this additional processing, due to one of the following:

- The processing is not required, because none of the object files in the application use constructed reentrancy, use long names, are DLL or are C++.

- The processing is handled by executing the prelinker step before running the binder.

The term *bind* refers to the case where the binder is required to perform this processing.

- With respect to executing code in an application:

The *linkage definition* refers to the program call linkage between program functions and methods. This includes the passing of control and parameters. Refer to "Program Linkage" in *z/OS XL C/C++ Language Reference* for more information on linkage specification.

Some platforms have a single linkage convention. z/OS has a number of linkage conventions, including standard operating system linkage, Extra Performance Linkage (XPLINK), and different non-XPLINK linkage conventions for C and C++.

## Notes on the prelinking process

You cannot use the prelinker if you are using the XPLINK, GOFF, or LP64 compiler options. IBM recommends using the binder instead of the prelinker whenever possible.

The prelinker was designed to process long names and support constructed reentrancy in earlier versions of the C compiler on the MVS and OS/390 operating systems. The prelinker, which is shipped with z/OS Language Environment, provides output that is compatible with the linkage editor, which is shipped with the binder.

The *binder* is designed to include the functions of the prelinker, the linkage editor, the loader, and a number of APIs to manipulate the program object. Thus, the binder is a superset of the linkage editor. Its functionality provides a high level of compatibility with the prelinker and linkage editor, but provides additional functionality in some areas. Generally, the terms *binding* and *linking* are interchangeable. In particular, the binder supports:

- Inputs from the object module
- XOBJ, GOFF, load module and program object
- Auto call resolutions from z/OS UNIX archives and C370LIB object directories
- Long external names
- All prelinker control statements

### Notes:

1. You need to use the binder for 64-bit objects.
2. As of z/OS V1R7, the Hierarchical File System (HFS) functionality has been stabilized and zSeries File System (zFS) is the strategic file system for z/OS UNIX System Services. The term *z/OS UNIX file system* includes both HFS and zFS.

For more information on the compatibility between the binder, and the linker and prelinker, see *z/OS MVS Program Management: User's Guide and Reference*.

Updates to the prelinking, linkage-editing, and loading functions that are performed by the binder are delivered through the binder. If you use the prelinker shipped with z/OS Language Environment, and the linkage editor (supplied through the binder), you have to apply the latest maintenance for the Language Environment as well as the binder.



## File format considerations

You can use the binder in place of the prelinker and linkage editor but there are exceptions involving file format considerations. For further information, on when you cannot use the binder, see Chapter 9, “Binding z/OS XL C/C++ programs,” on page 355.

## The program management binder

The binder provided with z/OS combines the object modules, load modules, and program objects comprising an application. It produces a single z/OS output program object or load module that you can load for execution. The binder supports all C and C++ code, provided that you store the output program in a PDSE member or a z/OS UNIX System Services file.

If you cannot use a PDSE member or z/OS UNIX file, and your program contains C++ code, or C code that is compiled with any of the RENT, LONGNAME, DLL or IPA compiler options, you must use the prelinker. C and C++ code compiled with the GOFF or XPLINK compiler options cannot be processed by the prelinker.

Using the binder without using the prelinker has the following advantages:

- Faster rebinds when recompiling and rebinding a few of your source files
- Rebinding at the single compile unit level of granularity (except when you use the IPA compile-time option)
- Input of object modules, load modules, and program objects
- Improved long name support:
  - Long names do not get converted into prelinker generated names
  - Long names appear in the binder maps, enabling full cross-referencing
  - Variables do not disappear after prelink
  - Fewer steps in the process of producing your executable program

The prelinker provided with z/OS Language Environment combines the object modules comprising a z/OS XL C/C++ application and produces a single object module. You can link-edit the object module into a load module (which is stored in a PDS), or bind it into a load module or a program object (which is stored in a PDS, PDSE, or z/OS UNIX file).

---

## z/OS UNIX System Services

z/OS UNIX System Services provides capabilities under z/OS to make it easier to implement or port applications in an open, distributed environment. z/OS UNIX is available to z/OS XL C/C++ application programs through the C/C++ language bindings available with z/OS Language Environment.

Together, z/OS UNIX, z/OS Language Environment, and the z/OS XL C/C++ compilers provide an application programming interface that supports industry standards.

z/OS UNIX provides support for both existing z/OS applications and new z/OS UNIX applications through the following:

- C programming language support as defined by ISO C
- C++ programming language support as defined by ISO C++
- C language bindings as defined in the IEEE 1003.1 and 1003.2 standards; subsets of the draft 1003.1a and 1003.4a standards; *X/Open CAE Specification: System Interfaces and Headers, Issue 4, Version 2*, which provides standard

interfaces for better source code portability with other conforming systems; and *X/Open CAE Specification, Network Services, Issue 4*, which defines the X/Open UNIX descriptions of sockets and X/Open Transport Interface (XTI)

- z/OS UNIX extensions that provide z/OS-specific support beyond the defined standards
- The z/OS UNIX Shell and Utilities feature, which provides:
  - A shell, based on the Korn Shell and compatible with the Bourne Shell
  - A shell, tcsh, based on the C shell, csh
  - Tools and utilities that support the *X/Open Single UNIX Specification*, also known as *X/Open Portability Guide (XPG) Version 4, Issue 2*, and provide z/OS support. The following is a partial list of utilities that are included:

|  |  |
|--|--|
| <b>ar</b>                              | Creates and maintains library archives   |
| <b>as</b>                              | Invokes HLASM to create assembler applications   |
| <b>BPXBATCH</b>                        | Allows you to submit batch jobs that run shell commands, scripts, or z/OS XL C/C++ executable files in z/OS UNIX files from a shell session                                      |
| <b>c89</b>                             | Uses host environment variables to compile, assemble, and bind z/OS UNIX, C/C++ and assembler applications   |
| <b>dbx</b>                             | Provides an environment to debug and run programs  |
| <b>gencat</b>                          | Merges the message text source files (usually *.msg) into a formatted message catalog file (usually *.cat)   |
| <b>iconv</b>                           | Converts characters from one code set to another   |
| <b>lex</b>                             | Automatically writes large parts of a lexical analyzer based on a description that is supplied by the programmer   |
| <b>localedef</b>                       | Creates a compiled locale object   |
| <b>make</b>                            | Helps you manage projects containing a set of interdependent files, such as a program with many z/OS source and object files, keeping all such files up to date with one another |
| <b>xlc</b>                             | Allows you to invoke the compiler using a customizable configuration file  |
| <b>yacc</b>                            | Allows you to write compilers and other programs that parse input according to strict grammar rules  |
| – Support for other utilities such as: |  |
| <b>dspcat</b>                          | Displays all or part of a message catalog  |
| <b>dspmsg</b>                          | Displays a selected message from a message catalog   |
| <b>mkcatdefs</b>                       | Preprocesses a message source file for input to the gencat utility   |
| <b>runcat</b>                          | Invokes mkcatdefs and pipes the message catalog source data (the output from mkcatdefs) to gencat  |

- Access to the Hierarchical File System (HFS), with support for the POSIX.1 and XPG4 standards
- Access to the zSeries File System (zFS), which provides performance improvements over HFS, and also supports the POSIX.1 and XPG4 standards
- z/OS XL C/C++ I/O routines, which support using z/OS UNIX files, standard z/OS data sets, or a mixture of both

- Application threads (with support for a subset of POSIX.4a)
- Support for z/OS XL C/C++ DLLs

z/OS UNIX System Services offers program portability across multivendor operating systems, with support for POSIX.1, POSIX.1a (draft 6), POSIX.2, POSIX.4a (draft 6), and XPG4.2.

For application developers who have worked with other UNIX environments, the z/OS UNIX Shell and Utilities is a familiar environment for XL C/C++ application development. If you are familiar with existing MVS development environments, you may find that the z/OS UNIX System Services environment can enhance your productivity. Refer to *z/OS UNIX System Services User's Guide* for more information on the Shell and Utilities.

---

## z/OS XL C/C++ applications with z/OS UNIX System Services C functions

All z/OS UNIX System Services C functions are available at all times. In some situations, you must specify the POSIX(ON) run-time option. This is required for the POSIX.4a threading functions, the POSIX `system()` function, and signal handling functions where the behavior is different between POSIX/XPG4 and ISO. Refer to *z/OS XL C/C++ Run-Time Library Reference* for more information about requirements for each function.

You can invoke a z/OS XL C/C++ program that uses z/OS UNIX C functions using the following methods:

- Directly from a shell.
- From another program, or from a shell, using one of the `exec` family of functions, or the `BPXBATCH` utility from TSO or MVS batch.
- Using the POSIX `system()` call.
- Directly through TSO or MVS batch without the use of the intermediate `BPXBATCH` utility. In some cases, you may require the POSIX(ON) run-time option.

---

## Input and output

The z/OS XL C/C++ run-time library that supports the z/OS XL C/C++ compiler supports different input and output (I/O) interfaces, file types, and access methods. The Standard C++ Library provides additional support.

## I/O interfaces

The z/OS XL C/C++ run-time library supports the following I/O interfaces:

### C Stream I/O

This is the default and the ISO-defined I/O method. This method processes all input and output on a per-character basis.

### Record I/O

The library can also process your input and output by record. A record is a set of data that is treated as a unit. It can also process VSAM data sets by record. Record I/O is a z/OS XL C/C++ extension to the ISO standard.

### TCP/IP Sockets I/O

z/OS UNIX System Services provides support for an enhanced version of an industry-accepted protocol for client/server communication that is known as *sockets*. A set of C language functions provides support for z/OS UNIX

sockets. z/OS UNIX sockets correspond closely to the sockets used by UNIX applications that use the Berkeley Software Distribution (BSD) 4.3 standard (also known as Berkeley sockets). The slightly different interface of the X/Open CAE Specification, Networking Services, Issue 4, is supplied as an additional choice. This interface is known as X/Open Sockets.

The z/OS UNIX socket application program interface (API) provides support for both UNIX domain sockets and Internet domain sockets. UNIX domain sockets, or *local sockets*, allow interprocess communication within z/OS, independent of TCP/IP. Local sockets behave like traditional UNIX sockets and allow processes to communicate with one another on a single system. With Internet sockets, application programs can communicate with each other in the network using TCP/IP.

In addition, the Standard C++ Library provides stream classes, which support formatted I/O in C++. You can code sophisticated I/O statements easily and clearly, and define input and output for your own data types. This helps improve the maintainability of programs that use input and output.

## File types

In addition to conventional files, such as sequential files and partitioned data sets, the z/OS XL C/C++ run-time library supports the following file types:

### Virtual Storage Access Method (VSAM) data sets

z/OS XL C/C++ has native support for the following VSAM data sets:

- Key-Sequenced Data Sets (KSDS). Use KSDS to access a record through a key within the record. A key is one or more consecutive characters that are taken from a data record that identifies the record.
- Entry-Sequenced Data Sets (ESDS). Use ESDS to access data in the order it was created (or in reverse order).
- Relative-Record Data Sets (RRDS). Use RRDS for data in which each item has a particular number (for example, a telephone system where a record is associated with each telephone number).

For more information on how to perform I/O operations on these VSAM file types, see "Performing VSAM I/O operations" in *z/OS XL C/C++ Programming Guide*.

### Hierarchical File System files

z/OS XL C/C++ recognizes Hierarchical File System (HFS) file names. The name specified on the `fopen()` or `freopen()` call has to conform to certain rules. See "Opening Files" in *z/OS XL C/C++ Programming Guide* for the details of these rules. You can create regular HFS files, special character HFS files, or FIFO HFS files. You can also create links or directories.

**Note:** As of z/OS V1R7, the Hierarchical File System (HFS) functionality has been stabilized and zSeries File System (zFS) is the strategic UNIX System Services file system for z/OS.

### Memory files

Memory files are temporary files that reside in memory. For improved performance, you can direct input and output to memory files rather than to devices. Since memory files reside in main storage and only exist while the program is executing, you primarily use them as work files. You can access memory files across load modules through calls to non-POSIX `system()`

and `C fetch()`; they exist for the life of the root program. Standard streams can be redirected to memory files on a non-POSIX system() call using command line redirection.

### **Hiperspace™ expanded storage**

Large memory files can be placed in Hiperspace expanded storage to free up some of your home address space for other uses. Hiperspace expanded storage or high performance space is a range of up to 2 GB of contiguous virtual storage space. A program can use this storage as a buffer (1 gigabyte(GB) =  $2^{30}$  bytes).

### **zSeries File System**

zSeries File System (zFS) is a z/OS UNIX file system that can be used in addition to the Hierarchical File System (HFS). zFS may provide performance gains in accessing files that are frequently accessed and updated. The I/O functions in the z/OS XL C/C++ run-time library support zFS.

## **Additional I/O features**

z/OS XL C/C++ provides additional I/O support through the following features:

- Large file support, which enables I/O to and from z/OS UNIX System Services files that are larger than 2 GB (see "large file support" in *z/OS XL C/C++ Language Reference*)
- User error handling for serious I/O failures (SIGIOERR)
- Improved sequential data access performance through enablement of the DFSMS support for 31-bit sequential data buffers and sequential data striping on extended format data sets
- Full support of PDSEs on z/OS (including support for multiple members opened for write)
- Overlapped I/O support under z/OS (NCP, BUFNO)
- Multibyte character I/O functions
- Fixed-point (packed) decimal data type support in formatted I/O functions
- Support for multiple volume data sets that span more than one volume of DASD or tape
- Support for Generation Data Group I/O

---

## **The System Programming C facility**

The System Programming C (SPC) facility allows you to build applications that do not require dynamic loading of z/OS Language Environment libraries. It also allows you to tailor your application for better utilization of the low-level services available on your operating system. SPC offers a number of advantages:

- You can develop applications that can be executed in a customized environment rather than with z/OS Language Environment services. Note that if you do not use z/OS Language Environment services, only some built-in functions and a limited set of z/OS XL C/C++ run-time library functions are available to you.
- You can substitute the z/OS XL C language in place of assembler language when writing system exit routines by using the interfaces that are provided by SPC.
- SPC lets you develop applications featuring a user-controlled environment in which a z/OS XL C environment is created once and used repeatedly for C function execution from other languages.

- You can utilize co-routines by using a two-stack model to write application service routines. In this model, the application calls on the service routine to perform services independent of the user. The application is then suspended when control is returned to the user application.

---

## Interaction with other IBM products

When you use z/OS XL C/C++, you can write programs that utilize the power of other IBM products and subsystems:

- CICS Transaction Server for z/OS

You can use the CICS Command-Level Interface to write C/C++ application programs. The CICS Command-Level Interface provides data, job, and task management facilities that are normally provided by the operating system.

- DB2 Universal Database™ (UDB) for z/OS

DB2 programs manage data that is stored in relational databases. You can access the data by using a structured set of queries that are written in Structured Query Language (SQL).

A DB2 program uses SQL statements that are embedded in the application program. The SQL translator (DB2 preprocessor) translates the embedded SQL into host language statements, which are then compiled by the z/OS XL C/C++ compilers. Alternatively, use the SQL compiler option to compile a DB2 program with embedded SQL without using the DB2 preprocessor. The DB2 program processes requests, then returns control to the application program.

- Debug Tool

z/OS XL C/C++ supports program development by using the Debug Tool. This tool allows you to debug applications in their native host environment, such as CICS Transaction Server for z/OS, IMS, and DB2. Debug Tool provides the following support and function:

- Step mode
- Breakpoints
- Monitor
- Frequency analysis
- Dynamic patching

You can record the debug session in a log file, and replay the session. You can also use Debug Tool to help capture test cases for future program validation, or to further isolate a problem within an application.

You can specify either data sets or z/OS UNIX System Services files as source files.

For further information, see [www.ibm.com/software/awdtools/debugtool/](http://www.ibm.com/software/awdtools/debugtool/).

- IBM C/C++ Productivity Tools for OS/390

**Note:** Starting with z/OS V1R5, both the C/C++ compiler optional feature and the Debug Tool product will need to be installed if you wish to use IBM C/C++ Productivity Tools for OS/390. For more information on Debug Tool, refer to [www.ibm.com/software/awdtools/debugtool/](http://www.ibm.com/software/awdtools/debugtool/).

With the IBM C/C++ Productivity Tools for OS/390 product, you can expand your z/OS application development environment out to the workstation, while remaining close to your familiar host environment. IBM C/C++ Productivity Tools for OS/390 includes the following workstation-based tools to increase your productivity and code quality:

- Performance Analyzer to help you analyze, understand, and tune your C and C++ applications for improved performance



- Distributed Debugger that allows you to debug C or C++ programs from the convenience of the workstation
- Workstation-based editor to improve the productivity of your C and C++ source entry
- Advanced online help, with full text search and hypertext topics as well as printable, viewable, and searchable Portable Document Format (PDF) documents

**Note:** References to *Performance Analyzer* in this document refer to the IBM OS/390 Performance Analyzer included in the IBM C/C++ Productivity Tools for OS/390 product.

In addition, IBM C/C++ Productivity Tools for OS/390 includes the following host components:

- Debug Tool
- Host Performance Analyzer

Use the Performance Analyzer on your workstation to graphically display and analyze a profile of the execution of your host z/OS XL C or C++ application. Use this information to time and tune your code so that you can increase the performance of your application.

Use the Distributed Debugger to debug your z/OS XL C or C++ application remotely from your workstation. Set a breakpoint with the simple click of the mouse. Use the windowing capabilities of your workstation to view multiple segments of your source and your storage, while monitoring a variable at the same time.

Use the workstation-based editor to quickly develop C and C++ application code that runs on z/OS. Context-sensitive help information is available to you when you need it.

- IBM Fault Analyzer for z/OS

The IBM Fault Analyzer helps developers analyze and fix application and system failures. It gathers information about an application and the surrounding environment at the time of the abend, providing the developer with valuable information needed for developing and testing new and existing applications. For more information, refer to: [www.ibm.com/software/awdtools/faultanalyzer/](http://www.ibm.com/software/awdtools/faultanalyzer/).

- Application Performance Analyzer for z/OS

The Application Performance Analyzer for z/OS is an application program performance analysis tool that helps you to:

- Optimize the performance of your existing application
- Improve the response time of your online transactions and batch turnaround times
- Isolate performance problems in applications

For more information, refer to: [www.ibm.com/software/awdtools/apa/](http://www.ibm.com/software/awdtools/apa/).

- ISPF Software Configuration and Library Manager facility (SCLM)

The ISPF Software Configuration and Library Manager facility (SCLM) maintains information about the source code, objects and load modules. It also keeps track of other relationships in your application, such as test cases, JCL, and publications. The SCLM Build function translates input to output, managing not only compilation and linking, but all associating processes required to build an application. This facility helps to ensure that your production load modules match the source in your production source libraries. For more information, refer to: [www.ibm.com/software/awdtools/ispf/features/sclm-ov.html](http://www.ibm.com/software/awdtools/ispf/features/sclm-ov.html).

- Graphical Data Display Manager (GDDM)

GDDM provides a comprehensive set of functions to display and print applications most effectively:

- A windowing system that the user can tailor to display selected information
- Support for presentation and keyboard interaction
- Comprehensive graphics support
- Fonts (including support for the double-byte character set)
- Business image support
- Saving and restoring graphic pictures
- Support for many types of display terminals, printers, and plotters

For more information, refer to: [www.ibm.com/software/applications/gddm/](http://www.ibm.com/software/applications/gddm/).

- Query Management Facility (QMF)

z/OS XL C supports the Query Management Facility (QMF), a query and report writing facility, which allows you to write applications through a callable interface. You can create applications to perform a variety of tasks, such as data entry, query building, administration aids, and report analysis. For more information, refer to: [www.ibm.com/software/data/qmf/](http://www.ibm.com/software/data/qmf/).

- z/OS Java support

The Java language supports the Java Native Interface (JNI) for making calls to and from C/C++. These calls do not use ILC support but rather the Java-defined JNI, which is supported by both compiled and interpreted Java code. Calls to C or C++ do not distinguish between these two.

---

## Additional features of z/OS XL C/C++

| Feature                                   | Description  |
|---|--|
| long long Data Type                       | z/OS XL C/C++ supports long long as a native data type when the compiler option LANGLVL(LONGLONG) is turned on. This option is turned on by default by the compiler option LANGLVL(EXTENDED). As of z/OS V1R7, the XL C compiler supports long long as a native data type (according to the ISO/IEC 9899:1999 standard), when the LANGLVL(STDC99) option or LANGLVL(EXTC99) option is in effect.   |
| Multibyte Character Support               | z/OS XL C/C++ supports multibyte characters for those national languages such as Japanese whose characters cannot be represented by a single byte.   |
| Wide Character Support                    | Multibyte characters can be normalized by z/OS XL C library functions and encoded in units of one length. These normalized characters are called wide characters. Conversions between multibyte and wide characters can be performed by string conversion functions such as <code>wcstombs()</code> , <code>mbstowcs()</code> , <code>wcsrombs()</code> , and <code>mbsrtowcs()</code> , as well as the family of wide-character I/O functions. Wide-character data can be represented by the <code>wchar_t</code> data type.  |
| Extended Precision Floating-Point Numbers | z/OS XL C/C++ provides three z/Architecture™ floating-point number data types: single precision (32 bits), declared as <code>float</code> ; double precision (64 bits), declared as <code>double</code> ; and extended precision (128 bits), declared as <code>long double</code> .<br><br>Extended precision floating-point numbers give greater accuracy to mathematical calculations.<br><br>As of OS/390 V2R6, C/C++ also supports IEEE 754 floating-point representation. By default, <code>float</code> , <code>double</code> , and <code>long double</code> values are represented in z/Architecture floating point format. However, the IEEE 754 floating-point representation is used if you specify the <code>FLOAT(IEEE754)</code> compiler option. For details on this support, see “FLOAT” on page 106. |
| Command Line Redirection                  | You can redirect the standard streams <code>stdin</code> , <code>stderr</code> , and <code>stdout</code> from the command line or when calling programs using the <code>system()</code> function.  |



| <b>Feature</b>  | <b>Description</b>   |
|---|--|
| National Language Support   | z/OS XL C/C++ provides message text in either American English or Japanese. You can dynamically switch between these two languages.  |
| Coded Character Set (Code Page) Support                               | The z/OS XL C/C++ compiler can compile C/C++ source written in different EBCDIC code pages. In addition, the iconv utility converts data or source from one code page to another.  |
| Selected Built-in Library Functions                                   | For selected library functions, the compiler generates an instruction sequence directly into the object code during optimization to improve execution performance. String and character functions are examples of these built-in functions. No actual calls to the library are generated when built-in functions are used.   |
| Multi-threading   | Threads are efficient in applications that allow them to take advantage of any underlying parallelism available in the host environment. This underlying parallelism in the host can be exploited either by forking a process and creating a new address space, or by using multiple threads within a single process. For more information, refer to "Using Threads in z/OS UNIX Applications" in <i>z/OS XL C/C++ Programming Guide</i> .   |
| Packed Structures and Unions  | z/OS XL C provides support for packed structures and unions. Structures and unions may be packed to reduce the storage requirements of a z/OS XL C program or to define structures that are laid out according to COBOL or PL/I structure alignment rules.   |
| Fixed-point (Packed) Decimal Data                                     | z/OS XL C supports fixed-point (packed) decimal as a native data type for use in business applications. The packed data type is similar to the COBOL data type COMP-3 or the PL/I data type FIXED DEC, with up to 31 digits of precision.  |
| Long Name Support   | For portability, external names can be mixed case and up to 32 K - 1 characters in length. For C++, the limit applies to the mangled version of the name.  |
| System Calls  | You can call commands or executable modules using the <code>system()</code> function under z/OS, z/OS UNIX System Services, and TSO. You can also use the <code>system()</code> function to call EXECs on z/OS and TSO, or shell scripts using z/OS UNIX System Services.  |
| Exploitation of Hardware  | <p>Use the ARCHITECTURE compiler option to select the minimum level of machine architecture on which your program will run. Note that certain features provided by the compiler require a minimum architecture level. For more information, refer to "ARCHITECTURE" on page 72.</p> <p>Use the TUNE compiler option to optimize your application for a specific machine architecture within the constraints imposed by the ARCHITECTURE option. The TUNE level must not be lower than the setting in the ARCHITECTURE option. For more information, refer to "TUNE" on page 211.</p> |
| Built-in Functions for Floating-Point and Other Hardware Instructions | Use built-in functions for floating-point and other hardware instructions that are otherwise inaccessible to XL C/C++ programs. For more information, see the built-in functions described in <i>z/OS XL C/C++ Programming Guide</i> .   |



---

## Part 2. User's reference

This part reviews the basic steps for compiling, binding, and running z/OS XL C/C++ programs under the z/OS operating system. It also describes the options available to you at compile, IPA Link, bind, and run time.

- Chapter 2, “z/OS XL C example,” on page 25
- Chapter 3, “z/OS XL C++ examples,” on page 31
- Chapter 4, “Compiler Options,” on page 45
- Chapter 5, “Binder options and control statements,” on page 285
- Chapter 6, “Run-Time options,” on page 287



---

## Chapter 2. z/OS XL C example

This chapter describes the basic steps to compile, bind, and run a C example program under z/OS batch, TSO, or the z/OS shell.

If you have not yet compiled a C program, some concepts in this chapter may be unfamiliar. Refer to Chapter 7, “Compiling,” on page 291, Chapter 9, “Binding z/OS XL C/C++ programs,” on page 355, and Chapter 11, “Running a C or C++ application,” on page 409 for a detailed description on compiling, binding, and running a C program.

This chapter describes steps to bind a C example program. It does not describe the prelink and link steps. If you are using the prelinker, see Appendix A, “Prelinking and linking z/OS XL C/C++ programs,” on page 549.

The example program that this chapter describes is shipped with the z/OS XL C compiler in the data set CBC.SCCNSAM.

---

### Example of a C program

The following example shows a simple z/OS XL C program that converts temperatures in Celsius to Fahrenheit. You can either enter the temperatures on the command line or let the program prompt you for the temperature.

In this example, the main program calls the function `convert()` to convert the Celsius temperature to a Fahrenheit temperature and to print the result.

#### CCNUAAM

```
#include <stdio.h>           1
#include "ccnuaan.h"        2
void convert(double);      3
int main(int argc, char **argv) 4
{
    double c_temp;         5
    if (argc == 1) { /* get Celsius value from stdin */
        printf("Enter Celsius temperature: \n"); 6
        if (scanf("%f", &c_temp) != 1) {
            printf("You must enter a valid temperature\n");
        }
        else {
            convert(c_temp); 7
        }
    }
}
```

Figure 2. Celsius-to-Fahrenheit conversion (Part 1 of 2)

```

else { /* convert the command-line arguments to Fahrenheit */
    int i;

    for (i = 1; i < argc; ++i) {
        if (sscanf(argv[i], "%f", &c_temp) != 1)
            printf("%s is not a valid temperature\n",argv[i]);
        else
            convert(c_temp); 7
    }
}
return 0;
}

void convert(double c_temp) { 8
    double f_temp = (c_temp * CONV + OFFSET);
    printf("%5.2f Celsius is %5.2f Fahrenheit\n",c_temp, f_temp);
}

```

Figure 2. Celsius-to-Fahrenheit conversion (Part 2 of 2)

## CCNUAAN

```

/*****
 * User include file: ccnuaan.h 9
 *****/

#define CONV (9./5.)
#define OFFSET 32

```

Figure 3. User #include file for the conversion program

- 1** The #include preprocessor directive names the stdio.h system file. stdio.h contains declarations of standard library functions, such as the printf() function used by this program.  
The compiler searches the system libraries for the stdio.h file. For more information about searches for include files, see “Search sequences for include files” on page 325.
- 2** The #include preprocessor directive names the CCNUAAN user file. CCNUAAN defines constants that are used by the program.  
The compiler searches the user libraries for the file CCNUAAN.  
If the compiler cannot locate the file in the user libraries, it searches the system libraries.
- 3** This is a function prototype declaration. This statement declares convert() as an external function having one parameter.
- 4** The program begins execution at this entry point.
- 5** This is the automatic (local) data definition to main().
- 6** This printf statement is a call to a library function that allows you to format your output and print it on the standard output device. The printf() function is declared in the standard I/O header file stdio.h included at the beginning of the program.
- 7** This statement contains a call to the convert() function, which was declared earlier in the program as receiving one double value, and not returning a value.

- 8** This is a function definition. In this example, the declaration for this function appears immediately before the definition of the `main()` function. The code for the function is in the same file as the code for the `main()` function.
- 9** This is the user include file containing the definitions for `CONV` and `OFFSET`.

If you need more details on the constructs of the z/OS XL C language, see *z/OS XL C/C++ Language Reference* and *z/OS XL C/C++ Run-Time Library Reference*.

---

## Compiling, binding, and running the z/OS XL C example

You can compile, bind, and run z/OS XL C programs under z/OS batch, TSO, or the z/OS shell. You cannot run the IPA Link step under TSO. For more information, see Chapter 7, “Compiling,” on page 291, Chapter 9, “Binding z/OS XL C/C++ programs,” on page 355, and Chapter 11, “Running a C or C++ application,” on page 409.

This document uses the term *user prefix* to refer to the high-level qualifier of your data sets. For example, in `PETE.TESTHDR.H`, the user prefix is `PETE`. Under TSO, your prefix is set or queried by the `PROFILE` command.

**Note:** The z/OS XL C compiler does not support TSO `PROFILE NOPREFIX`.

### Under z/OS batch

Copy the IBM-supplied sample program and header file into your data set. For example, if your user prefix is `PETE`, store the sample program (`CCNUAAM`) in `PETE.TEST.C(CTOF)` and the header file in `PETE.TESTHDR.H(CCNUAAN)`. You can use the IBM-supplied cataloged procedure `EDCCBG` to compile, bind, and run the example program as follows:

```
//DOCLG      EXEC  PROC=EDCCBG,INFILE='PETE.TEST.C(CTOF)',
//          CPARM='LSEARCH(''''PETE.TESTHDR.'''')'
//GO.SYSIN   DD  DATA,DLM=@@
19
@@
```

Figure 4. JCL to compile, bind, and run the example program using the `EDCCBG` procedure

In Figure 4, the `LSEARCH` statement describes where to find the user include files. The system header files will be searched in the data sets specified on the `SEARCH` compiler option, which defaults to `CEE.SCEEH.+`. The `GO.SYSIN` statement indicates that the input that follows it is given for the execution of the program.

### XPLINK under z/OS batch

Figure 5 shows the JCL for building with `XPLINK`.

```
//DOCLG      EXEC  PROC=EDCXCBG,INFILE='PETE.TEST.C(CTOF)',
//          CPARM='LSEARCH(''''PETE.TESTHDR.'''')'
//GO.SYSIN   DD  DATA,DLM=@@
19
@@
```

Figure 5. JCL to build with `XPLINK`

## Non-XPLINK and XPLINK under TSO

Copy the IBM-supplied sample program and header file into your data set. For example, if your user prefix is PETE, store the sample z/OS XL C program (CCNUAAM) in PETE.TEST.C(CTOF) and the header file in PETE.TESTHDR.H(CCNUAAN).

### Steps for compiling, binding, and running the example program using TSO commands

**Before you begin:** Ensure that the z/OS Language Environment run-time libraries SCEERUN and SCEERUN2, and the z/OS XL C compiler are in the STEPLIB, LPALST, or LNKLST concatenation.

Perform the following steps to compile, bind, and run the example program using TSO commands:

1. Compile the z/OS XL C source. You can use the REXX EXEC CC to invoke the z/OS XL C compiler under TSO as follows:

```
%CC TEST.C(CTOF) (LSEARCH(TESTHDR.H)
```

```
-- or, for XPLINK --
```

```
%CC TEST.C(CTOF) (LSEARCH(TESTHDR.H) XPLINK
```

The REXX EXEC CC compiles CTOF with the default compiler options and stores the resulting object module in PETE.TEST.C.OBJ(CTOF).

The compiler searches for user header files in the PDS PETE.TESTHDR.H, which you specified at compile time by the LSEARCH option. The system header files are searched in the data sets specified with the SEARCH compiler option, which defaults to CEE.SCEEH.+.

For more information see “Compiling under TSO” on page 302.

---

2. Perform a bind:

```
CXXBIND OBJ(TEST.C.OBJ(CTOF)) LOAD(TEST.C.LOAD(CTOF))
```

```
-- or, for XPLINK --
```

```
CXXBIND OBJ(TEST.C.OBJ(CTOF)) LOAD(TEST.C.LOAD(CTOF)) XPLINK
```

CXXBIND binds the object module PETE.TEST.C.OBJ(CTOF) to create an executable module CTOF in the PDSE PETE.TEST.C.LOAD, with the default bind options. See Chapter 9, “Binding z/OS XL C/C++ programs,” on page 355 for more information.

---

3. Run the program:

```
CALL TEST.C.LOAD(CTOF)
```

**Example:** When a message appears asking you to enter a Celsius temperature, enter, for example, 25.

**Result:** The load module displays the following output: 25.00 Celsius is 77.00 Fahrenheit

CALL runs CTOF from PETE.TEST.C.LOAD with the default run-time options in effect. See Chapter 11, “Running a C or C++ application,” on page 409 for more information.

---



## Non-XPLINK and XPLINK under the z/OS UNIX System Services shell

### Steps for compiling, binding, and running the example program using UNIX commands

**Before you begin:** Put the source in the z/OS UNIX file system and ensure that the z/OS Language Environment run-time libraries SCEERUN and SCEERUN2, and the z/OS XL C compiler are in the STEPLIB, LPALST, or LNKST concatenation.

Perform the following steps to compile, bind, and run the example program using z/OS UNIX commands:

1. From the z/OS shell, type the following:

```
cp "'/cbc.sccnsam(ccnuaam)'" ccnuaam.c
cp "'/cbc.sccnsam(ccnuaan)'" ccnuaan.h
```

---

2. Compile and bind:

```
c89 -o ctof ccnuaam.c
```

```
-- or, for XPLINK --
```

```
c89 -o ctof -Wc,xplink -Wl,xplink ccnuaam.c
```

---

3. Run the program:

```
./ctof
```

**Example:** When a message appears asking you to enter a Celsius temperature, enter, for example, 25.

**Result:** The load module displays the following output: 25.00 Celsius is 77.00 Fahrenheit

---



---

## Chapter 3. z/OS XL C++ examples

This chapter describes the basic steps to compile, bind, and run z/OS XL C++ example programs under z/OS batch, TSO, or the z/OS shell.

If you have not yet compiled a C++ program, some concepts in this chapter may be unfamiliar. Refer to Chapter 7, “Compiling,” on page 291, Chapter 9, “Binding z/OS XL C/C++ programs,” on page 355, and Chapter 11, “Running a C or C++ application,” on page 409 for a detailed description on compiling, binding, and running a C++ program.

The example programs that this chapter describes are shipped with the z/OS XL C++ compiler. Example programs with the names CCNUxxx are shipped in the data set CCN.SCCNSAM. Example programs with the names CLB3xxxx are shipped in the z/OS UNIX System Services file system in /usr/lpp/cbc1ib/sample.

---

### Example of a C++ program

The following example shows a z/OS XL C++ program that prompts you to enter a birth date. The program output is the corresponding biorhythm chart.

The program is written using an object-oriented method. A class that is called BioRhythm is defined. It contains an object birthDate of class BirthDate, which is derived from the class Date. An object that is called bio of the class BioRhythm is declared.

The example contains two files. File CCNUBRH contains the classes that are used in the main program. File CCNUBRC contains the remaining source code. The example files CCNUBRC and CCNUBRH are shipped with the z/OS XL C++ compiler in data sets CBC.SCCNSAM(CCNUBRC) and CBC.SCCNSAM(CCNUBRH).

If you need more details on the constructs of the z/OS XL C++ language, see *z/OS XL C/C++ Language Reference* or *z/OS XL C/C++ Run-Time Library Reference*.

## CCNUBRH

```
//  
// Sample Program: Biorhythm  
// Description   : Calculates biorhythm based on the current  
//                system date and birth date entered  
//  
// File 1 of 2-other file is CCNUBRC  
  
class Date {  
public:  
    Date();  
    int DaysSince(const char *date);  
  
protected:  
    int curYear, curDay;  
    static const int dateLen = 10;  
    static const int numMonths = 12;  
    static const int numDays[];  
};  
  
class BirthDate : public Date {  
public:  
    BirthDate();  
    BirthDate(const char *birthText);  
    int DaysOld() { return(DaysSince(text)); }  
  
private:  
    char text[Date::dateLen+1];  
};
```

*Figure 6. Header file for the biorhythm example (Part 1 of 2)*

```

class BioRhythm {
public:
    BioRhythm(char *birthText) : birthDate(birthText) {
        age = birthDate.DaysOld();
    }
    BioRhythm() : birthDate() {
        age = birthDate.DaysOld();
    }
    ~BioRhythm() {}

    int AgeInDays() {
        return(age);
    }
    double Physical() {
        return(Cycle(pCycle));
    }
    double Emotional() {
        return(Cycle(eCycle));
    }
    double Intellectual() {
        return(Cycle(iCycle));
    }
    int ok() {
        return(age >= 0);
    }

private:
    int age;
    double Cycle(int phase) {
        return(sin(fmod((double)age, (double)phase) / phase * M_2PI));
    }
    BirthDate birthDate;
    static const int pCycle=23;    // Physical cycle - 23 days
    static const int eCycle=28;    // Emotional cycle - 28 days
    static const int iCycle=33;    // Intellectual cycle - 33 days
};

```

Figure 6. Header file for the biorhythm example (Part 2 of 2)

## CCNUBRC

```
//  
// Sample Program: Biorhythm  
// Description   : Calculates biorhythm based on the current  
//                system date and birth date entered  
//  
// File 2 of 2-other file is CCNUBRH  
  
#include <stdio.h>  
#include <string.h>  
#include <math.h>  
#include <time.h>  
#include <iostream>  
#include <iomanip>  
  
#include "ccnubr.h" //BioRhythm class and Date class  
using namespace std;  
static ostream& operator << (ostream&, BioRhythm&);  
  
int main(void) {  
  
    BioRhythm bio;  
    int code;  
  
    if (!bio.ok()) {  
        cerr << "Error in birthdate specification - format is yyyy/mm/dd";  
        code = 8;  
    }  
    else {  
        cout << bio; // write out birthdate for bio  
        code = 0;  
    }  
    return(code);  
}  
  
const int Date::dateLen ;  
const int Date::numMonths;  
const int Date::numDays[Date::numMonths] = {  
    31, 28, 31, 30, 31, 30, 31, 31, 30, 31, 30, 31  
};  
  
const int BioRhythm::pCycle;  
const int BioRhythm::eCycle;  
const int BioRhythm::iCycle;  
  
ostream& operator<<(ostream& os, BioRhythm& bio) {  
    os << "Total Days   : " << bio.AgeInDays() << "\n";  
    os << "Physical      : " << bio.Physical() << "\n";  
    os << "Emotional    : " << bio.Emotional() << "\n";  
    os << "Intellectual: " << bio.Intellectual() << "\n";  
  
    return(os);  
}
```

Figure 7. z/OS XL C++ Biorhythm example program (Part 1 of 3)

```

Date::Date() {
    time_t lTime;
    struct tm *newTime;

    time(&lTime);
    newTime = localtime(&lTime);
    cout << "local time is " << asctime(newTime) << endl;

    curYear = newTime->tm_year + 1900;
    curDay = newTime->tm_yday + 1;
}

BirthDate::BirthDate(const char *birthText) {
    strcpy(text, birthText);
}

BirthDate::BirthDate() {
    cout << "Please enter your birthdate in the form yyyy/mm/dd\n";
    cin >> setw(dateLen+1) >> text;
}

Date::DaysSince(const char *text) {

    int year, month, day, totDays, delim;
    int daysInYear = 0;
    int i;
    int leap = 0;

    int rc = sscanf(text, "%4d%c%2d%c%2d",
                   &year, &delim, &month, &delim, &day);
    --month;
    if (rc != 5 || year < 0 || year > 9999 ||
        month < 0 || month > 11 ||
        day < 1 || day > 31 ||
        (day > numDays[month] && month != 1)) {
        return(-1);
    }
    if ((year % 4 == 0 && year % 100 != 0) || year % 400 == 0)
        leap = 1;

    if (month == 1 && day > numDays[month]) {
        if (day > 29)
            return(-1);
        else if (!leap)
            return (-1);
    }
}

```

Figure 7. z/OS XL C++ Biorhythm example program (Part 2 of 3)

```

    for (i=0;i<month;++i) {
        daysInYear += numDays[i];
    }
    daysInYear += day;

    // correct for leap year
    if (leap == 1 &&
        (month > 1 || (month == 1 && day == 29)))
        ++daysInYear;

    totDays = (curDay - daysInYear) + (curYear - year)*365;

    // now, correct for leap year
    for (i=year+1; i < curYear; ++i) {
        if ((i % 4 == 0 && i % 100 != 0) || i % 400 == 0) {
            ++totDays;
        }
    }
    return(totDays);
}

```

Figure 7. z/OS XL C++ Biorhythm example program (Part 3 of 3)

---

## Compiling, binding, and running the z/OS XL C++ example

You can compile, bind, and run z/OS XL C++ programs under z/OS batch, TSO, or the z/OS shell. You cannot run the IPA Link step under TSO. For more information, see Chapter 7, “Compiling,” on page 291, Chapter 9, “Binding z/OS XL C/C++ programs,” on page 355, and Chapter 11, “Running a C or C++ application,” on page 409.

This document uses the term *user prefix* to refer to the high-level qualifier of your data sets. For example, in CEE.SCEERUN, the user prefix is CEE.

**Note:** The z/OS XL C++ compiler does not support TSO PROFILE NOPREFIX.

### Under z/OS batch

Copy the IBM-supplied sample program and header file into your data set. For example, if your user prefix is PETE, store the sample program CCNUBRC in PETE.TEST.C(CCNUBRC), and the header file CCNUBRH in PETE.TESTHDR.H(CCNUBRH). You can use the IBM-supplied cataloged procedure CBCCBG to compile, bind, and run the source code as follows:

```

/*
/* COMPILE, BIND AND RUN
/*
//DOCLG EXEC CBCCBG,
// INFILE='PETE.TEST.C(CCNUBRC)',
// CPARM='OPTFILE(DD:CCOPT)'
//COMPILE.CCOPT DD *
        LSEARCH('PETE.TESTHDR.H')
        SEARCH('CEE.SCEEH.+','CBC.SCLBH.+')
/*
/* ENTER A DATE IN THE FORM YYYY/MM/DD
//GO.SYSIN DD *
        1997/10/19
/*

```

Figure 8. JCL to compile, bind, and run the example program using the CBCCBG procedure



In Figure 8 on page 36, the LSEARCH statement describes where to find the user include files, and the SEARCH statement describes where to find the system include files. The GO.SYSIN statement indicates that the input that follows it is given for the execution of the program.

### XPLINK under z/OS batch

The following example shows how to compile, bind, and run a program with XPLINK using the CBCXCBG procedure:

```

/*
/* COMPILE, BIND AND RUN
/*
//DOCLG EXEC CBCXCBG,
// INFIL= 'PETE.TEST.C(CCNUBRC)',
// CPARM= 'OPTFILE(DD:CCOPT)'
//COMPILE.CCOPT DD *
// LSEARCH('PETE.TESTHDR.H')
// SEARCH('CEE.SCEEH.+','CBC.SCLBH.+')
/*
/* ENTER A DATE IN THE FORM YYYY/MM/DD
//GO.SYSIN DD *
// 1997/10/19
/*

```

Figure 9. JCL to compile, bind, and run the example program with XPLINK using the CBCXCBG procedure

For more information on compiling, binding, and running, see Chapter 7, “Compiling,” on page 291, Chapter 9, “Binding z/OS XL C/C++ programs,” on page 355, and Chapter 11, “Running a C or C++ application,” on page 409.

## Non-XPLINK and XPLINK under TSO

Copy the IBM-supplied sample program and header file into your data set. For example, if your user prefix is PETE, store the sample program CCNUBRC in PETE.TEST.C(CCNUBRC), and the header file CCNUBRH in PETE.TESTHDR.H(CCNUBRH).

### Steps for compiling, binding, and running the C++ example program using TSO commands

**Before you begin:** Ensure that the z/OS Language Environment run-time libraries SCEERUN and SCEERUN2, the z/OS class library DLLs, and the z/OS XL C++ compiler are in the STEPLIB, dynamic LPA, or Link List concatenation.

Perform the following steps to compile, bind, and run the example program using TSO commands:

1. Compile the z/OS XL C++ source. You can use the REXX EXEC CXX to invoke the z/OS XL C++ compiler under TSO as follows:

```
CXX 'PETE.TEST.C(CCNUBRC)' ( LSEARCH('PETE.TESTHDR.H') OBJECT(BIO.TEXT)
SEARCH('CEE.SCEEH.+','CBC.SCLBH.+')
```

-- or, for XPLINK --

```
CXX 'PETE.TEST.C(CCNUBRC)' ( LSEARCH('PETE.TESTHDR.H') OBJECT(BIO.TEXT)
SEARCH('CEE.SCEEH.+','CBC.SCLBH.+') XPLINK
```

CXX compiles CCNUBRC with the specified compiler options and stores the resulting object module in PETE.BIO.TEXT(CCNUBRC).

The compiler searches for user header files in the PDS PETE.TESTHDR.H, which you specified at compile time with the LSEARCH option. The compiler

searches for system header files in the PDS CEE.SCEEH.+ and PDS CBC.SCLBH.+, which you specified at compile time with the SEARCH option. For more information see “Compiling under TSO” on page 302.

---

## 2. Bind:

```
CXXBIND OBJ(BIO.TEXT(CCNUBRC)) LOAD(BIO.LOAD(BIORUN))
```

-- or, for XPLINK --

```
CCXXBIND OBJ(BIO.TEXT(CCNUBRC)) LOAD(BIO.LOAD(BIORUN)) XPLINK
```

CXXBIND binds the object module PETE.BIO.TEXT(CCNUBRC), and creates an executable module BIORUN in PETE.BIO.LOAD PDSE with the default bind options.

**Note:** To avoid a bind error, the data set PETE.BIO.LOAD must be a PDSE, not a PDS.

For more information see Chapter 9, “Binding z/OS XL C/C++ programs,” on page 355.

---

## 3. Run the program:

```
CALL BIO.LOAD(BIORUN)
```

**Example:** When you are asked to enter your birthdate, enter, for example, 1999/01/03.

**Result:** The following information displays:

```
Total Days : 1116
Physical    : -0.136167
Emotional   : -0.781831
Intellectual: -0.909632
```

CALL runs the module BIORUN from the PDSE PETE.BIO.LOAD with the default run-time options.

For more information see “Running an application under TSO” on page 412.

---

## Non-XPLINK and XPLINK under the z/OS UNIX shell

### Steps for compiling, binding, and running the C++ example program using UNIX commands

**Before you begin:** Put the source in the z/OS UNIX file system. From the z/OS shell type:

```
cp "'/cbc.sccsam(ccnubrc)'" ccnubrc.C
cp "'/cbc.sccsam(ccnubrh)'" ccnubrh.h
```

This example uses the current working directory so make sure that you are in the directory you want to use. Use the **pwd** command to display the current working directory, the **mkdir** command to create a new directory, and the **cd** command to change directories.

Ensure that the z/OS Language Environment run-time libraries SCEERUN and SCEERUN2, the z/OS class library DLLs, and the z/OS XL C++ compiler are in the STEPLIB, dynamic LPA, or Link List concatenation.

Perform the following steps to compile, bind, and run the example program using z/OS UNIX commands:

1. Compile and bind:

```
c++ -o bio ccubrc.C
```

```
-- or, for XPLINK --
```

```
c++ -o bio -Wc,xplink -Wl,xplink ccubrc.C
```

**Note:** You can use **c++** to compile source that is stored in a data set.

---

2. Run the program:

```
./bio
```

**Example:** When you are asked to enter your birthdate, enter, for example, 1999/01/03.

**Result:** The following information displays:

```
Total Days : 1116  
Physical    : -0.136167  
Emotional   : -0.781831  
Intellectual: -0.909632
```

---

---

## Example of a C++ template program

A *class template* or generic class is a blueprint that describes how members of a set of related classes are constructed.

The following example shows a simple z/OS XL C++ program that uses templates to perform simple operations on linked lists. It resides in the z/OS UNIX System Services file system in the directory /usr/lpp/cbclib/sample/clb3atmp. The main program, CLB3ATMP.CXX (see “CLB3ATMP.CXX” on page 40), uses three header files that are from the Standard C++ Library: list, string, and iostream. It has one class template: list.

## CLB3ATMP.CXX

```
#include <list>
#include <string>
#include <iostream>
using namespace std;

template <class Item> class IOList {
public:
    IOList() : myList() {}
    void write();
    void read(const char *msg);
    void append(Item item) {
        myList.push_back(item);
    }
private:
    list<Item> myList;
};

template <class Item> void IOList<Item>::write() {
    ostream_iterator<Item> oi(cout, " ");
    copy(myList.begin(), myList.end(), oi);
    cout << '\n';
}

template <class Item> void IOList<Item>::read(const char *msg) {
    Item item;
    cout << msg << endl;
    istream_iterator<Item> ii(cin);
    copy(ii, istream_iterator<Item>(), back_inserter<list<Item> >(myList));
}

int main() {
    IOList<string> stringList;
    IOList<int> intList;

    char line1[] = "This program will read in a list of ";
    char line2[] = "strings, integers and real numbers";
    char line3[] = "and then print them out";

    stringList.append(line1);
    stringList.append(line2);
    stringList.append(line3);
    stringList.write();
    intList.read("Enter some integers (/* to terminate)");
    intList.write();

    string name1 = "Bloe, Joe";
    string name2 = "Jackson, Joseph";

    if (name1 < name2)
        cout << name1 << " comes before " << name2;
    else
        cout << name2 << " comes before " << name1;
    cout << endl;
}
```

Figure 10. z/OS XL C++ template program (Part 1 of 2)

```
int num1 = 23;
int num2 = 28;
if (num1 < num2)
    cout << num1 << " comes before " << num2;
else
    cout << num2 << "comes before " << num1;
cout << endl;

return(0);
}
```

Figure 10. z/OS XL C++ template program (Part 2 of 2)

---

## Compiling, binding, and running the C++ template example

This section describes the commands to compile, bind and run the template example under z/OS batch, TSO, and the z/OS shell.

### Under z/OS batch

#### Steps for compiling, binding, and running the C++ template example program under z/OS batch

**Before you begin:** Ensure that the z/OS Language Environment run-time libraries SCEERUN and SCEERUN2, and the z/OS XL C++ compiler are in STEPLIB, LPALST, or the LNKST concatenation.

Perform the following step to compile, bind, and run the C++ template example program under z/OS batch:

- Change <userhlq> to your own user prefix in the example JCL.
-

## CCNUNCL

```
//Jobcard info
//PROC JCLLIB ORDER=(CBC.SCCNPRC,
//  CEE.SCEEPROC)
//*
//* Compile MAIN program,creating an object deck
//*
//MAINCC EXEC CBCX,
//  OUTFILE='<userhlq>.SAMPLE.OBJ(CLB3ATMP),DISP=SHR ',
//  CPARAM='XPLINK,OPTF(DD:COPTS)'
//SYSIN DD PATH='/usr/lpp/cbc1ib/sample/clb3atmp/clb3atmp.cpp'
//COPTS DD *
//  SEARCH('CEE.SCEEH.+','CBC.SCLBH.+')
//*
//*
//* Bind the program
//*
//BIND EXEC CBCXB,
//  INFILE='<userhlq>.SAMPLE.OBJ(CLB3ATMP)',
//  OUTFILE='<userhlq>.SAMPLE.LOAD(CLB3ATMP),DISP=SHR'
//*
//* Run the program
//*
//GO EXEC CBCXG,
//  INFILE='<userhlq>.SAMPLE.LOAD',
//  GOPGM=CLB3ATMP
//GO.SYSIN DD *
//  1 2 5 3 7 8 3 2 10 11
//*
```

Figure 11. JCL to compile, bind and run the template example

## Under TSO

### Steps for compiling, running, and binding the C++ template example program using TSO commands

**Before you begin:** Ensure that the z/OS Language Environment run-time libraries SCEERUN and SCEERUN2, the z/OS Class Library DLLs, and the z/OS XL C++ compiler are in STEPLIB, LPALST, or the LNKLST concatenation.

Perform the following steps to compile, bind, and run the C++ template example program using TSO commands:

1. Compile the source files:

- a. `cxx /usr/lpp/cbclib/sample/clb3atmp.cpp (lsearch(/usr/lpp/cbclib/sample) search('cee.sceeh.+','cbc.sclbh.+') obj(sample.obj(clb3atmp)) tempinc(//tempinc)`

This step compiles CLB3ATMP with the default compiler options, and stores the object module in *userhlq*.SAMPLE.OBJ(CLB3ATMP), where *userhlq* is your user prefix. The template instantiation files are written to the PDS *userhlq*.TEMPINC.

- b. `cxx TEMPINC (lsearch(/usr/lpp/cbclib/sample) search('cee.sceeh.+','cbc.sclbh.+')`

This step compiles the PDS TEMPINC and creates the corresponding objects in the PDS *userhlq*.TEMPINC.OBJ.

See “Compiling under TSO” on page 302 for more information.

---

2. Create a library from the PDS *userhlq*.TEMPINC.OBJ:

```
C370LIB DIR LIB(TEMPINC.OBJ)
```

For more information see “Creating an object library under TSO” on page 438

---

3. Bind the program:

```
CXXBIND OBJ(SAMPLE.OBJ(CLB3ATMP)) LIB(TEMPINC.OBJ) LOAD(SAMPLE.LOAD(CLB3ATMP))
```

This step binds the *userhlq*.SAMPLE.OBJ(CLB3ATMP) text deck using the *userhlq*.TEMPINC.OBJ library and the default bind options. It also creates the executable module *userhlq*.SAMPLE.LOAD(CLB3ATMP).

**Note:** To avoid a binder error, the data set *userhlq*.SAMPLE.LOAD must be a PDSE.

For more information see “Binding under TSO using CXXBIND” on page 378.

---

4. Run the program:

```
CALL SAMPLE.LOAD(CLB3ATMP)
```

This step executes the module *userhlq*.SAMPLE.LOAD(CLB3ATMP) using the default run-time options. For more information see “Running an application under TSO” on page 412.

---

## Under the z/OS UNIX shell

### Steps for compiling, binding, and running the C++ template example program using UNIX commands

**Before you begin:** Ensure that the z/OS Language Environment run-time libraries SCEERUN and SCEERUN2, and the z/OS XL C++ compiler are in STEPLIB, LPALST, or the LNKLST concatenation.

Perform the following steps to compile, run, and bind the template example program under the z/OS shell:

1. Copy sample files to your own directory, as follows:

```
cp /usr/lpp/cbclib/sample/clb3atmp/* your_dir/.
```

---

2. Then, to compile and bind:

```
c++ -+ -o clb3atmp clb3atmp.cpp
```

This command compiles `clb3atmp.cpp` and then compiles the `./tempinc` directory (which is created if it does not already exist). It then binds using all the objects in the `./tempinc` directory. An archive file, or C370LIB object library is not created.

---

3. Run the program:

```
./clb3atmp
```

---



---

## Chapter 4. Compiler Options

This chapter describes the options that you can use to alter the compilation of your program.

---

### Specifying compiler options

You can override your installation default options when you compile your z/OS XL C/C++ program, by specifying an option in one of the following ways:

- In the option list when you invoke the IBM-supplied REXX EXECs.
- In the CPARM parameter of the IBM-supplied cataloged procedures, when you are compiling under z/OS batch.

See Chapter 7, “Compiling,” on page 291, and Chapter 12, “Cataloged procedures and REXX EXECs,” on page 419 for details.

- In your own JCL procedure, by passing a parameter string to the compiler.
- In an options file. See “OPTFILE | NOOPTFILE” on page 167 for details.
- For z/OS XL C, in a **#pragma options** preprocessor directive within your source file. See “Specifying z/OS XL C compiler options using #pragma options” on page 49 for details.

Compiler options that you specify on the command line or in the CPARM parameter of IBM-supplied cataloged procedures can override compiler options that are used in **#pragma options**. The exception is CSECT, where the **#pragma csect** directive takes precedence.

- On the command line of the c89 utility, by using the **-Wc**, **WI**, and **-WI,I** options to pass options to the compiler.
- On the command line of the xlc utility, by using the **-q** option or the **-Wc** and **-WI,I** options to pass options to the compiler.

The following compiler options are inserted in your object module to indicate their status:

AGGRCOPY  
ALIAS (C compile only)  
ANSIALIAS  
ARCHITECTURE  
ARGPARSE  
ASCII  
BITFIELD  
CHARS  
COMPACT  
COMPRESS  
CONVLIT  
CSECT  
CVFT (C++ compile only)  
DEBUG  
DLL  
EXECOPS  
EXPORTALL  
FLOAT  
GOFF  
GONUMBER  
HGPR

|                   |                    |
|-------------------|--------------------|
| HOT               |                    |
| IGNERRNO          |                    |
| ILP32             |                    |
| INITAUTO          |                    |
| INLINE            |                    |
| IPA               |                    |
| LANGLVL           |                    |
| LIBANSI           |                    |
| LOCALE            |                    |
| LONGNAME          |                    |
| LP64              |                    |
| MAXMEM            |                    |
| OBJECTMODEL       | (C++ compile only) |
| OPTIMIZE          |                    |
| PLIST             |                    |
| REDIR             |                    |
| RENT              | (C compile only)   |
| ROCONST           |                    |
| ROSTRING          |                    |
| ROUND             |                    |
| RTTI              | (C++ compile only) |
| SERVICE           |                    |
| SPILL             |                    |
| START             |                    |
| STRICT            |                    |
| STRICT_INDUCTION  |                    |
| TARGET            |                    |
| TEMPLATERECOMPILE | (C++ compile only) |
| TEMPLATEREGISTRY  | (C++ compile only) |
| TMPLPARSE         | (C++ compile only) |
| TEST              |                    |
| TUNE              |                    |
| UNROLL            |                    |
| UPCONV            | (C compile only)   |
| XPLINK            |                    |

## IPA considerations

The following sections explain what you should be aware of if you request Interprocedural Analysis (IPA) through the IPA option. Before you use the IPA compiler option, refer to an overview of IPA in *z/OS XL C/C++ Programming Guide*.

### Applicability of compiler options under IPA

You should keep the following points in mind when specifying compiler options for the IPA Compile or IPA Link step:

- Many compiler options do not have any special effect on IPA. For example, the PPOONLY option processes source code, then terminates processing prior to IPA Compile step analysis.
- Compiler options for IPA(OBJONLY) compiles are the same as for NOIPA compiles.
- #pragma directives in your source code, and compiler options you specify for the IPA Compile step, may conflict across compilation units.  
#pragma directives in your source code, and compiler options you specify for the IPA Compile step, may conflict with options you specify for the IPA Link step.

IPA will detect such conflicts and apply default resolutions with appropriate diagnostic messages. The Compiler Options Map section of the IPA Link step listing displays the conflicts and their resolutions.

To avoid problems, use the same options and suboptions on the IPA Compile and IPA Link steps. Also, if you use `#pragma` directives in your source code, specify the corresponding options for the IPA Link step.

- If you specify a compiler option that is irrelevant for a particular IPA step, IPA ignores it and does not issue a message.

In this chapter, the description of each compiler option includes its effect on IPA processing.

### Interactions between compiler options and IPA suboptions

During IPA Compile step processing, IPA handles conflicts between IPA suboptions and certain compiler options that affect code generation.

If you specify a compiler option for the IPA Compile step, but do not specify the corresponding suboption of the IPA option, the compiler option may override the IPA suboption. Table 5 shows how the OPT, LIST, and GONUMBER compiler options interact with the OPT, LIST, and GONUMBER suboptions of the IPA option. The `xxxx` indicates the name of the option or suboption. `NOxxxx` indicates the corresponding negative option or suboption.

Table 5. Interactions between compiler options and IPA suboptions

| Compiler Option     | Corresponding IPA Suboption | Value used in IPA Object |
|---------------------|-----------------------------|--------------------------|
| no option specified | no suboption specified      | NOxxxx                   |
| no option specified | NOxxxx                      | NOxxxx                   |
| no option specified | xxxx                        | xxxx                     |
| NOxxxx              | no option specified         | NOxxxx                   |
| NOxxxx              | NOxxxx                      | NOxxxx                   |
| NOxxxx              | xxxx                        | xxxx                     |
| xxxx                | no option specified         | xxxx                     |
| xxxx                | NOxxxx                      | xxxx <sup>1</sup>        |
| xxxx                | xxxx                        | xxxx                     |

**Note:** <sup>1</sup>An informational message is produced that indicates that the suboption `NOxxxx` is promoted to `xxxx`.

### IPA compiles versus compiles with IPA optimization

The IPA(OBJONLY) compilation is an intermediate level of optimization. This results in a modified regular compile, not an IPA Compile step. Unlike the IPA Compile step, no IPA information is written to the object file.

The object file may be used by an IPA Link step, a prelink (or link), or a bind. If it is used as input to an IPA Link step, IPA Link-time optimizations cannot be performed for this compilation unit because no IPA information is available.

## Using special characters

### Under TSO

When z/OS UNIX System Services file names contain the special characters

- blank
- backslash
- double quote

A backslash ( \ ) must precede these characters.

**Note:** Under TSO, a backslash \ must precede special characters in file names and options.

Two backslashes must precede suboptions that contain these special characters:

- left parenthesis (
- right parenthesis )
- comma
- backslash
- blank
- double quote
- less than <
- greater than >

For example:

```
def(errno=\\(*__errno\\(\\)\\))
```

### Under the z/OS UNIX System Services shell

The z/OS UNIX System Services shell imposes its own parsing rules. The `c89` utility escapes special compiler and run-time characters as needed to invoke the compiler, so you need only be concerned with shell parsing rules.

While the `c89` utility uses compiler options, which have parentheses, `xlc` uses the `-q` syntax, which does not use parentheses and is more convenient for shell invocation.

See Chapter 20, “`c89` — Compiler invocation using host environment variables,” on page 489 and Chapter 21, “`xlc` — Compiler invocation using a customizable configuration file,” on page 527 for more information.

### Under z/OS batch

When invoking the compiler directly (not through a cataloged procedure), you should type a single quote (') within a string as two single quotes (""), as follows:

```
//COMPILE EXEC PGM=CCNDRVR,PARM='OPTFILE(''USERID.OPTS'')
```

If you are using the same string to pass a parameter to a JCL PROC, use four single quotes (""""), as follows:

```
//COMPILE EXEC CBCC,C Parm='''''OPTFILE(''USERID.OPTS'')'''
```

Special characters in z/OS UNIX System Services file names that are referenced in DD cards do not need a preceding backslash. For example, the special character blank in the file name `obj 1.o` does not need a preceding backslash when it is used in a DD card:

```
//SYSLIN DD PATH='u/user1/obj 1.o'
```

A backslash must precede special characters in z/OS UNIX System Services file names that are referenced in the PARM statement. The special characters are: backslash, blank, and double quote. For example, a backslash precedes the special character blank in the file name obj 1.o, when used in the PARM keyword:

```
//STEP1 EXEC PGM=CCNDRVR,PARM='OBJ(/u/user1/obj\ 1.o)'
```

## Specifying z/OS XL C compiler options using #pragma options

You can use the **#pragma options** preprocessor directive to override the default values for compiler options. Compiler options that are specified on the command line or in the CPARM parameter of the IBM-supplied cataloged procedures can override compiler options that are used in **#pragma options**. The exception is CSECT, where the **#pragma csect** directive takes precedence. For complete details on the **#pragma options** preprocessor directive, see *z/OS XL C/C++ Language Reference*.

The **#pragma options** preprocessor directive must appear before the first z/OS XL C statement in your input source file. Only comments and other preprocessor directives can precede the **#pragma options** directive. Only the options that are listed below can be specified in a **#pragma options** directive. If you specify a compiler option that is not in the following list, the compiler generates a warning message, and does not use the option.

|           |              |
|-----------|--------------|
| AGGREGATE | ALIAS        |
| ANSIALIAS | ARCHITECTURE |
| CHECKOUT  | GONUMBER     |
| IGNERRNO  | INLINE       |
| LIBANSI   | MAXMEM       |
| OBJECT    | OPTIMIZE     |
| RENT      | SERVICE      |
| SPILL     | START        |
| TEST      | TUNE         |
| UPCONV    | XREF         |

### Notes:

1. When you specify conflicting attributes explicitly, or implicitly by the specification of other options, the last explicit option is accepted. The compiler usually does not issue a diagnostic message indicating that it is overriding any options.
2. When you compile your program with the SOURCE compiler option, an options list in the listing indicates the options in effect at invocation. The values in the list are the options that are specified on the command line, or the default options that were specified at installation. These values do not reflect options that are specified in the **#pragma options** directive.

## Specifying compiler options under z/OS UNIX System Services

The c89 and xlc utilities invoke the z/OS XL C/C++ compiler with the C and C++ compiler options. For further information, see “Compiler option defaults” on page 50.

To change compiler options, use an appropriate c89 or xlc utility option. For example, use -I to set the search option that specifies where to search for #include files. If there is no appropriate c89 or xlc option, use -q or -Wc to specify a desired compiler option. For example, specify **-Wc,expo** to export all functions and variables.

For a complete description of c89, xlc, and related utilities, refer to Chapter 20, “c89 — Compiler invocation using host environment variables,” on page 489 or Chapter 21, “xlc — Compiler invocation using a customizable configuration file,” on page 527.

For compiler options that take file names as suboptions, you can specify a sequential data set, a partitioned data set, or a partitioned data set member by prefixing the name with two slashes (//). The rest of the name follows the same syntax rule for naming data sets. Names that are not preceded with two slashes are z/OS UNIX System Services file names. For example, to specify HQ.PROG.LIST as the source listing file (HQ being the high-level qualifier), use SOURCE(// 'HQ.PROG.LIST'). The single quote is needed for specifying a full file name with a high-level qualifier.

**Note:** As of z/OS V1R8, the IPA Link step makes use of 64-bit virtual memory, which may cause the z/OS XL C/C++ compiler to abend if there is insufficient storage. Increasing the default MEMLIMIT system parameter size in the SMFPRMx parmlib member to 3000 MB can overcome the problem. The default takes effect if a job does not specify MEMLIMIT in the JCL JOB or EXEC statement, or REGION=0 in the JCL; the MEMLIMIT specified in an IEFUSI exit routine overrides all other MEMLIMIT settings. For information on the **ulimit** command, which can be used in z/OS UNIX to set MEMLIMIT, see *z/OS UNIX System Services Command Reference*. For additional information about the MEMLIMIT system parameter, see *z/OS MVS Programming: Extended Addressability Guide*.

---

## Compiler option defaults

You can use various options to change the compilation of your program. You can specify compiler options when you invoke the compiler or, in a C program, in a **#pragma options** directive in your source program. Options, that you specify when you invoke the compiler, override installation defaults and compiler options that are specified through a **#pragma options** directive.

The compiler option defaults that are supplied by IBM can be changed to other selected defaults when z/OS XL C/C++ is installed. For further information, see Appendix F, “Customizing default options for z/OS XL C/C++ compiler,” on page 621.

To find out the current defaults, compile a program with only the SOURCE compiler option specified. The compiler listing shows the options that are in effect at invocation. The listing does not reflect options that are specified through a **#pragma options** directive in the source file.

The c89, and xlc utilities that run in the z/OS UNIX System Services shell specify certain compiler options in order to support POSIX standards. For a complete description of these utilities, refer to Chapter 20, “c89 — Compiler invocation using host environment variables,” on page 489, Chapter 21, “xlc — Compiler invocation using a customizable configuration file,” on page 527, or to the *z/OS UNIX System Services Command Reference*. For some options, these utilities specify values that are different than the supplied defaults in MVS batch or TSO environments. However, for many options, they specify the same values as in MVS batch or TSO. There are also some options that the above utilities do not specify explicitly. In those cases, the default value is the same as in batch or TSO. An option that you specify explicitly using the above z/OS UNIX System Services utilities overrides the

setting of the same option if it is specified using a **#pragma options** directive. The exception is CSECT, where the **#pragma csect** directive takes precedence.

In effect, invoking the compiler with the c89, and xlc utilities overrides the default values for many options, compared to running the compiler in MVS batch or TSO. For example, the c89 utility specifies the RENT option, while the compiler default in MVS batch or TSO is NORENT. Any overrides of the defaults by the c89, and xlc utilities are noted in the DEFAULT category for the option. As the compiler defaults can always be changed during installation, you should always consult the compiler listing to verify the values passed to the compiler. See “Using the z/OS XL C compiler listing” on page 220 and “Using the z/OS XL C++ compiler listing” on page 257 for more information.

The c89 utility remaps the following options to the values shown. Note that these values are set for a regular (non-IPA) compile. These values will change if you invoke IPA Compile, IPA Link, or specify certain other options. For example, specifying the **c89 -V** option changes the settings of many of the compiler listing options. See Chapter 20, “c89 — Compiler invocation using host environment variables,” on page 489 or Chapter 21, “xlc — Compiler invocation using a customizable configuration file,” on page 527 for more information and also refer to the default information provided for each compiler option.

The **c89** options remapped are as follows:

```
LOCALE(POSIX)
LANGLVL(ANSI)
OE
LONGNAME
RENT
OBJECT(file_name.o)
NOLIST(/dev/fd1)
NOSOURCE(/dev/fd1)
NOPPONLY(NOCOMMENTS,NOLINES,/dev/fd1,2048)
FLAG(W)
DEFINE(errno=\\(*_errno\\(\\)\\))
DEFINE(_OPEN_DEFAULT=1)
```

The **c89** command name supported by the xlc utility has the same defaults as the **c89** command name supported by the c89 utility.

The **cc** options remapped are as follows:

```
NOANSIALIAS
LOCALE(POSIX)
LANGLVL(COMMONC)
OE
LONGNAME
RENT
OBJECT(file_name.o)
NOLIST(/dev/fd1)
NOSOURCE(/dev/fd1)
NOPPONLY(NOCOMMENTS,NOLINES,/dev/fd1,2048)
FLAG(W)
DEFINE(errno=\\(*_errno\\(\\)\\))
DEFINE(_OPEN_DEFAULT=0)
DEFINE(_NO_PROTO=1)
```

The **cc** command name supported by the xlc utility has the same defaults as the **cc** command name supported by the c89 utility.

The **c++** options remapped are as follows:

```

LOCALE(POSIX)
OE
OBJECT(file_name.o)
NOINLRPT(/dev/fd1)
NOLIST(/dev/fd1)
NOSOURCE(/dev/fd1)
NOPPONLY(NOCOMMENTS,NOLINES,/dev/fd1,2048)
FLAG(W)
DEFINE(errno=\\(*_errno\\(\\)\\))
DEFINE(_OPEN_DEFAULT=1)

```

All C++ command names (**xlc**, **cxx**, **c++**, **xlc++**) supported by the xlc utility have the same defaults as the **c++** and **cxx** commands supported by the c89 utility.

The **xlc** and **c99** command names supported by the xlc utility have the same defaults as the **c89** command name supported by the c89 utility, except for the following:

- LANGLVL(EXTENDED) is the default for the **xlc** command name
- LANGLVL(STD99) is the default for the **c99** command name
- SSCOMM is the default for both the **c99** and **xlc** command names

Note that the **locale** option is set according to the environment where the **cc**, **c89**, and **c++** commands are invoked. The current execution locale is determined by the values associated with environment variables LANG and LC\_ALL. The following list shows the order of precedence for determining the current execution locale:

- If you specify LC\_ALL, the current execution locale will be the value associated with LC\_ALL.
- If LC\_ALL was not specified but LANG was specified, the current execution locale will be the value associated with LANG.
- If neither of the two environment variables is specified, the current execution locale will default to "C".
- If the current execution locale is "C", the compiler will be invoked with LOCALE(POSIX); otherwise, it will be invoked with the current execution locale.

Note that for SEARCH, the *value* is determined by the following:

- Additional include search directories identified by the **c89 -I** options. Refer to Chapter 20, "c89 — Compiler invocation using host environment variables," on page 489 for more information.
- z/OS UNIX System Services environment variable settings: *prefix\_INCDIRS*, *prefix\_INCLIBS*, and *prefix\_CYSLIB*. They are normally set during compiler installation to reflect the compiler and run-time include libraries. Refer to "Environment variables" on page 504 in Chapter 20, "c89 — Compiler invocation using host environment variables," on page 489 for more information.

Refer to "SEARCH | NOSEARCH" on page 183 for more information on SEARCH.

For the remainder of the compiler options, the c89 utility default matches the C/C++ default. Some of these are explicitly specified by **c89**, **cc**, or **c++**. Therefore if the installation changes the default options, you may find that **c89**, **cc**, or **c++** continues to use the default options. You can use the `_C89_OPTIONS`, `_CC_OPTIONS`, or `_CXX_OPTIONS` environment variable to override these settings if necessary. Note that certain options are required for the correct execution of **c89**, **cc**, or **c++**.



## Summary of compiler options

Most compiler options have a positive and negative form. The negative form is the positive with NO before it. For example, NOXREF is the negative form of XREF. The table that follows lists the compiler options in alphabetical order, their abbreviations, and the defaults that are supplied by IBM. Suboptions inside square brackets are optional.

**Note:** For a description of the compiler options that can be specified with **xlc**, type **xlc -help** to access the help file.

The C, C++, and IPA Link columns, which are shown in the table below, indicate where the option is accepted by the compiler but this acceptance does not necessarily cause an action; for example, IPA LINK accepts the MARGINS option but ignores it. "C" refers to a C language compile step. "C++" refers to a C++ language compile step. These options are accepted regardless of whether they are for NOIPA, IPA (OBJONLY), or IPA(NOLINK).

Table 6. Compiler options, abbreviations, and IBM supplied defaults

| Compiler Option (Abbreviated Names are underlined)                                    | IBM Supplied Default               | C | C++ | IPA Link | More Information |
|---|------------------------------------|---|-----|----------|------------------|
| <u>AGGRCOPY</u> ( <u>OVERLAP</u>   <u>NOOVERLAP</u> )                                 | AGGRC(NOOVERL)                     | ✓ | ✓   | ✓        | See 67           |
| <u>AGGREGATE</u>   <u>NOAGGREGATE</u>   | NOAGG                              | ✓ |     | ✓        | See 68           |
| <u>ALIAS</u> [(name)]   <u>NOALIAS</u>  | NOALI                              | ✓ |     | ✓        | See 68           |
| <u>ANSIALIAS</u>   <u>NOANSIALIAS</u>   | ANS                                | ✓ | ✓   | ✓        | See 69           |
| <u>ARCHITECTURE</u> ( n)  | ARCH(5)                            | ✓ | ✓   | ✓        | See 72           |
| <u>ARGPARSE</u>   <u>NOARGPARSE</u>   | ARG                                | ✓ | ✓   | ✓        | See 74           |
| <u>ASCII</u>   <u>NOASCII</u>   | NOASCII                            | ✓ | ✓   | ✓        | See 75           |
| <u>ATTRIBUTE</u> [(FULL)]   <u>NOATTRIBUTE</u>  | NOATT                              |   | ✓   | ✓        | See 76           |
| <u>BITFIELD</u> (SIGNED UNSIGNED)   | BITF(UNSIGNED)                     | ✓ | ✓   | ✓        | See 77           |
| <u>CHARS</u> (SIGNED   UNSIGNED)  | CHARS(UNSIGNED)                    | ✓ | ✓   | ✓        | See 77           |
| <u>CHECKOUT</u> (subopts)   <u>NOCHECKOUT</u>   | NOCHE                              | ✓ |     | ✓        | See 78           |
| <u>CICS</u>   <u>NOCICS</u>   | NOCICS                             | ✓ | ✓   | ✓        | See 80           |
| <u>COMPACT</u>   <u>NOCOMPACT</u>   | NOCOMPACT                          | ✓ | ✓   | ✓        | See 82           |
| <u>COMPRESS</u>   <u>NOCOMPRESS</u>   | NOCOMPRESS                         | ✓ | ✓   | ✓        | See 83           |
| <u>CONVLIT</u> [(subopts)]   <u>NOCONVLIT</u> [(subopts)]                             | NOCONV (, NOWCHAR)                 | ✓ | ✓   | ✓        | See 84           |
| <u>CSECT</u> [(qualifier)]   <u>NOCSECT</u> [(qualifier)]                             | NOCSE for NOGOFF or CSE() for GOFF | ✓ | ✓   | ✓        | See 86           |
| <u>CVFT</u>   <u>NOCVFT</u>   | CVFT                               |   | ✓   |          | See 89           |
| <u>DBRMLIB</u> (filename)   | DBRMLIB(DD:DBRMLIB)                | ✓ | ✓   | ✓        | See 90           |
| <u>DEBUG</u> [(subopts)]   <u>NODEBUG</u> [(subopts)]                                 | NODEBUG                            | ✓ | ✓   |          | See 91           |
| <u>DEFINE</u> (name1[=   =def1], name2[=   =def2],...)                                | no default user definitions        | ✓ | ✓   | ✓        | See 94           |
| <u>DIGRAPH</u>   <u>NODIGRAPH</u>   | DIGR                               | ✓ | ✓   | ✓        | See 95           |
| <u>DLL</u> ( <u>CBA</u>   <u>NOCBA</u> )   <u>NODLL</u> ( <u>CBA</u>   <u>NOCBA</u> ) | NODLL(NOCBA)                       | ✓ |     | ✓        | See 97           |
| <u>DLL</u> ( <u>CBA</u>   <u>NOCBA</u> )  | DLL(NOCBA)                         |   | ✓   | ✓        | See 97           |
| <u>ENUMSIZE</u> (subopts)   | ENUM(SMALL)                        | ✓ | ✓   | ✓        | See 99           |
| <u>EVENTS</u> [(filename)]   <u>NOEVENTS</u>  | NOEVENT                            | ✓ | ✓   | ✓        | See 101          |

Table 6. Compiler options, abbreviations, and IBM supplied defaults (continued)

| Compiler Option (Abbreviated Names are underlined)        | IBM Supplied Default  | C | C++ | IPA Link | More Information |
|---|---|---|-----|----------|------------------|
| <u>EXECOPS</u>   <u>NOEXECOPS</u>                         | EXEC  | ✓ | ✓   | ✓        | See 102          |
| <u>EXH</u>   <u>NOEXH</u>                                 | EXH   |   | ✓   |          | See 103          |
| <u>EXPMAC</u>   <u>NOEXPMAC</u>                           | NOEXP   | ✓ | ✓   | ✓        | See 103          |
| <u>EXPORTALL</u>   <u>NOEXPORTALL</u>                     | NOEXPO  | ✓ | ✓   | ✓        | See 104          |
| <u>FASTTEMPINC</u>   <u>NOFASTTEMPINC</u>                 | NOFASTT   |   | ✓   |          | See 104          |
| <u>FLAG</u> (severity)   <u>NOFLAG</u>                    | FL(l)   | ✓ | ✓   | ✓        | See 105          |
| <u>FLOAT</u> (subopts)                                    | FLOAT(HEX, FOLD, NOMAF, NORRM, NOAFP or AFP(VOLATILE   NOVOLATILE). For ARCH(2) the default is FLOAT(NOAFP). For ARCH(3) or higher, the default is FLOAT(AFP(NOVOLATILE)).                                      | ✓ | ✓   | ✓        | See 106          |
| <u>GOFF</u>   <u>NOGOFF</u>                               | NOGOFF  | ✓ | ✓   | ✓        | See 111          |
| <u>GONUMBER</u>   <u>NOGONUMBER</u>                       | NOGONUM   | ✓ | ✓   | ✓        | See 111          |
| <u>HALT</u> (num)   | HALT(16)  | ✓ | ✓   | ✓        | See 113          |
| <u>HALTONMSG</u> (msgno)   <u>NOHALTONMSG</u>             | NOHALTON  | ✓ | ✓   | ✓        | See 113          |
| <u>HGPR</u>   <u>NOHGPR</u>                               | NOHGPR  | ✓ | ✓   | ✓        | See 114          |
| <u>HOT</u>   <u>NOHOT</u>                                 | NOHOT, if the xlc flag option is less than -O4. and HOT, if -O4 or -O5 is specified   | ✓ | ✓   |          | See 114          |
| <u>IGNERRNO</u>   <u>NOIGNERRNO</u>                       | NOIGNER   | ✓ | ✓   | ✓        | See 115          |
| <u>INFO</u> [(subopts)]   <u>NOINFO</u>                   | For C++: IN(LAN)<br>For C: NOIN   | ✓ | ✓   |          | See 116          |
| <u>INITAUTO</u> (number [,word])   <u>NOINITAUTO</u>      | NOINITA   | ✓ | ✓   | ✓        | See 118          |
| <u>INLINE</u> (subopts)   <u>NOINLINE</u> [(subopts)]     | C/C++ NOOPT:<br>NOINL(AUTO, NOREPORT, 100, 1000) C/C++ OPT:<br>INL(AUTO, NOREPORT, 100, 1000)<br><br>IPA Link NOOPT:<br>NOINL(AUTO, NOREPORT, 1000, 8000)<br><br>IPA Link OPT: INL (AUTO, NOREPORT, 1000, 8000) | ✓ | ✓   | ✓        | See 119          |
| <u>INLRPT</u> [(filename)]   <u>NOINLRPT</u> [(filename)] | NOINLR  | ✓ | ✓   | ✓        | See 123          |
| <u>IPA</u> [(subopts)]   <u>NOIPA</u> [(subopts)]         | NOIPA(NOLINK, OBJECT, OPT, NOLIST, NOGONUMBER, NOATTRIBUTE, NOXREF, LEVEL(1),NOMAP, DUP, ER, NONCAL, NOUPCASE, NOCONTROL, NOPDF1, NOPDF2, NOPDFNAME)  | ✓ | ✓   | ✓        | See 124          |

Table 6. Compiler options, abbreviations, and IBM supplied defaults (continued)

| Compiler Option (Abbreviated Names are underlined)          | IBM Supplied Default   | C | C++ | IPA Link | More Information |
|---|--|---|-----|----------|------------------|
| <u>KEYWORD</u> (name)   <u>NOKEYWORD</u> (name)             | Recognizes all C++ keywords  |   | ✓   | ✓        | See 132          |
| <u>LANGLVL</u> (subopts)                                    | LANG(EXTENDED)   | ✓ | ✓   | ✓        | See 132          |
| <u>LIBANSI</u>   <u>NOLIBANSI</u>                           | NOLIB  | ✓ | ✓   | ✓        | See 145          |
| <u>LIST</u> [(filename)]   <u>NOLIST</u> [(filename)]       | NOLIS  | ✓ | ✓   | ✓        | See 146          |
| <u>LOCALE</u> [(name)]   <u>NOLOCALE</u>                    | NOLOC  | ✓ | ✓   | ✓        | See 148          |
| <u>LONGNAME</u>   <u>NOLONGNAME</u>                         | C:NOLO C++: LO   | ✓ | ✓   | ✓        | See 149          |
| <u>LP64</u>   <u>ILP32</u>                                  | ILP32  | ✓ | ✓   | ✓        | See 150          |
| <u>LSEARCH</u> (subopts)   <u>NOLSEARCH</u>                 | NOLSE  | ✓ | ✓   | ✓        | See 153          |
| <u>MARGINS</u>   <u>NOMARGINS</u>                           | NOMAR  |   | ✓   |          | See 158          |
| <u>MARGINS</u> (m,n)   <u>NOMARGINS</u>                     | V-format: NOMAR F-format: MAR(1,72)  | ✓ |     | ✓        | See 158          |
| <u>MAXMEM</u> (size)   <u>NOMAXMEM</u>                      | MAXM(2097152)  | ✓ | ✓   | ✓        | See 159          |
| <u>MEMORY</u>   <u>NOMEMORY</u>                             | MEM  | ✓ | ✓   | ✓        | See 161          |
| <u>NAMEMANGLING</u> (subopt)                                | NAMEMANGLING(zOSV1R2)  |   | ✓   | ✓        | See 161          |
| <u>NESTINC</u> (num)   <u>NONESTINC</u>                     | NEST(255)  | ✓ | ✓   | ✓        | See 163          |
| <u>OBJECT</u> [(filename)]   <u>NOOBJECT</u> [(filename)]   | OBJ  | ✓ | ✓   | ✓        | See 163          |
| <u>OBJECTMODEL</u> (subopt)                                 | OBJECTMODEL(COMPAT)  |   | ✓   | ✓        | See 165          |
| <u>OE</u> [(filename)]   <u>NOOE</u> [(filename)]           | NOOE   | ✓ | ✓   | ✓        | See 165          |
| <u>OFFSET</u>   <u>NOOFFSET</u>                             | NOOF   | ✓ | ✓   | ✓        | See 166          |
| <u>OPTFILE</u> [(filename)]   <u>NOOPTFILE</u> [(filename)] | NOOPTF   | ✓ | ✓   | ✓        | See 167          |
| <u>OPTIMIZE</u> [(level)]   <u>NOOPTIMIZE</u>               | NOOPT  | ✓ | ✓   | ✓        | See 169          |
| <u>PHASEID</u>   <u>NOPHASEID</u>                           | NOPHASEID  | ✓ | ✓   | ✓        | See 172          |
| <u>PLIST</u> (HOST   OS)                                    | PLIST(HOST)  | ✓ | ✓   | ✓        | See 173          |
| <u>PORT</u> (PPS   NOPPS)   <u>NOPORT</u> (PPS   NOPPS)     | NOPORT(NOPPS)  |   | ✓   |          | See 174          |
| <u>PPONLY</u> [(subopts)]   <u>NOPPOONLY</u> [(subopts)]    | NOPP   | ✓ | ✓   | ✓        | See 175          |
| <u>REDIR</u>   <u>NOREDIR</u>                               | RED  | ✓ | ✓   | ✓        | See 178          |
| <u>RENT</u>   <u>NORENT</u>                                 | NORENT   | ✓ |     | ✓        | See 178          |
| <u>ROCONST</u>   <u>NOROCONST</u>                           | C: NOROC<br>C++: ROC   | ✓ | ✓   | ✓        | See 179          |
| <u>ROSTRING</u>   <u>NOROSTRING</u>                         | ROS  | ✓ | ✓   | ✓        | See 181          |
| <u>ROUND</u> (opt)  | For IEE: ROUND(N) For HEX: ROUND(Z)  | ✓ | ✓   | ✓        | See 182          |
| <u>RTTI</u>   <u>NORTTI</u>                                 | NORTTI   |   | ✓   | ✓        | See 183          |
| <u>SEARCH</u> (opt1,opt2,...)   <u>NOSEARCH</u>             | For C++, SE(//CEE.SCEEH.+,<br>//CBC.SCLBH.+') For C,<br>SE(//CEE.SCEEH.+') | ✓ | ✓   | ✓        | See 183          |
| <u>SEQUENCE</u>   <u>NOSEQUENCE</u>                         | NOSEQ  |   | ✓   |          | See 185          |
| <u>SEQUENCE</u> (m,n)   <u>NOSEQUENCE</u>                   | V-format: NOSEQ F-format: SEQ(73,80)                                       | ✓ |     | ✓        | See 185          |
| <u>SERVICE</u> (string)   <u>NOSERVICE</u>                  | NOSERV   | ✓ | ✓   | ✓        | See 186          |

Table 6. Compiler options, abbreviations, and IBM supplied defaults (continued)

| Compiler Option (Abbreviated Names are underlined)          | IBM Supplied Default   | C | C++ | IPA Link | More Information |
|---|--|---|-----|----------|------------------|
| <u>SHOWINC</u>   <u>NOSHOWINC</u>                           | NOSHOW   | ✓ | ✓   | ✓        | See 187          |
| <u>SOURCE</u> [(filename)]   <u>NOSOURCE</u> [(filename)]   | NOSO   | ✓ | ✓   | ✓        | See 187          |
| <u>SPILL</u> (size)   <u>NOSPILL</u> [(size)]               | SP(128)  | ✓ | ✓   | ✓        | See 188          |
| <u>SPLITLIST</u>   <u>NOSPLITLIST</u>                       | NOSPLITLIST  | ✓ | ✓   | ✓        | See 190          |
| <u>SQL</u>   <u>NOSQL</u>                                   | NOSQL  | ✓ | ✓   | ✓        | See 193          |
| <u>SSCOMM</u>   <u>NOSSCOMM</u>                             | NOSS   | ✓ |     | ✓        | See 194          |
| <u>START</u>   <u>NOSTART</u>                               | STA  | ✓ | ✓   | ✓        | See 195          |
| <u>STATICINLINE</u>   <u>NOSTATICINLINE</u>                 | NOSTATICI  |   | ✓   | ✓        | See 195          |
| <u>STRICT</u>   <u>NOSTRICT</u>                             | STRICT   | ✓ | ✓   | ✓        | See 196          |
| <u>STRICT_INDUCTION</u>   <u>NOSTRICT_INDUCTION</u>         | NOSTRICT_INDUC   | ✓ | ✓   | ✓        | See 197          |
| <u>SUPPRESS</u> (msg-no)   <u>NOSUPPRESS</u>                | NOSUPP   | ✓ | ✓   | ✓        | See 198          |
| <u>TARGET</u> (suboption)                                   | TARG(LE, CURRENT)  | ✓ | ✓   | ✓        | See 198          |
| <u>TEMPINC</u> [(filename)]   <u>NOTEMPINC</u> [(filename)] | PDS: TEMPINC(TEMPINC)<br><br>z/OS UNIX System Services file system directory: TEMPINC(/.tempinc) |   | ✓   |          | See 203          |
| <u>TEMPLATERECOMPILE</u>   <u>NOTEMPLATERECOMPILE</u>       | TEMPLATEREC  |   | ✓   |          | See 204          |
| <u>TEMPLATEREGISTRY</u>   <u>NOTEMPLATEREGISTRY</u>         | NOTEMPL  |   | ✓   | ✓        | See 205          |
| <u>TERMINAL</u>   <u>NOTERMINAL</u>                         | TERM   | ✓ | ✓   | ✓        | See 206          |
| <u>TEST</u> [(subopts)]   <u>NOTEST</u> [(subopts)]         | C: NOTEST (HOOK, SYM, BLOCK, LINE, PATH)<br><br>C++: NOTEST(HOOK)                                | ✓ | ✓   | ✓        | See 206          |
| <u>TMPLPARSE</u> (subopts)                                  | TMPLPARSE(NO)  |   | ✓   |          | See 210          |
| <u>TUNE</u> (n)   | TUN(5)   | ✓ | ✓   | ✓        | See 211          |
| <u>UNDEFINE</u> (name)                                      | no default   | ✓ | ✓   | ✓        | See 213          |
| <u>UNROLL</u> (subopts)                                     | UNROLL(AUTO)   | ✓ | ✓   | ✓        | See 213          |
| <u>UPCONV</u>   <u>NOUPCONV</u>                             | NOUPC  | ✓ |     | ✓        | See 214          |
| <u>WARN64</u>   <u>NOWARN64</u>                             | NOWARN64   | ✓ | ✓   | ✓        | See 215          |
| <u>WSIZEOF</u>   <u>NOWSIZEOF</u>                           | NOWSIZEOF  | ✓ | ✓   | ✓        | See 215          |
| <u>XPLINK</u> [(subopts)]   <u>NOXPLINK</u> [(subopts)]     | NOXPL  | ✓ | ✓   | ✓        | See 216          |
| <u>XREF</u>   <u>NOXREF</u>                                 | NOXR   | ✓ | ✓   | ✓        | See 220          |

## Compiler options for file management

These options specify the data set or z/OS UNIX System Services file system directory where the compiler stores output files, and they also direct the search for include files by the compiler.

Table 7. Compiler options for file management

| Option            | Description  | C Compile | C++ Compile | IPA Link | More Information |
|-------------------|--|-----------|-------------|----------|------------------|
| DBRMLIB           | Enables the SQL option to be used in the z/OS UNIX environment.  | ✓         | ✓           | ✓        | See 90           |
| FASTTEMPINC       | Defers generating object code until the final version of all template definitions have been determined. Then, a single compilation pass generates the final object code, resulting in improved compilation time when recursive templates are used in an application. |           | ✓           |          | See 104          |
| IPA(CONTROL)      | Indicates the name of the control file that contains additional directives for the IPA Link step. This option only affects the IPA Link step.  | ✓         | ✓           | ✓        | See 127          |
| LSEARCH           | Specifies the libraries or disks to be scanned for user include files.   | ✓         | ✓           | ✓        | See 153          |
| MEMORY            | Improves compile-time performance by using a MEMORY file in place of a work file, if possible.   | ✓         | ✓           | ✓        | See 161          |
| OBJECT            | Produces an object module, and stores it in the file that you specify, or in the data set associated with SYSLIN.  | ✓         | ✓           | ✓        | See 163          |
| OE                | When the file name that is provided is ambiguous, specifies that file names used in compiler options and include directives should be interpreted as z/OS UNIX file names. Also specifies that POSIX.2 standard rules for include file searching should be used.     | ✓         | ✓           | ✓        | See 165          |
| OPTFILE           | Directs the compiler to look for compiler options in the file specified.   | ✓         | ✓           | ✓        | See 167          |
| SEARCH            | Specifies the libraries or disks to be scanned for system include files.   | ✓         | ✓           | ✓        | See 183          |
| TEMPINC           | Places template instantiation files in the PDS or z/OS UNIX file system directory specified.   |           | ✓           |          | See 203          |
| TEMPLATERECOMPILE | Helps to manage dependencies between compilation units that have been compiled using the TEMPLATEREGISTRY option.  |           | ✓           | ✓        | See 204          |
| TEMPLATEREGISTRY  | Maintains records of all templates as they are encountered in the source and ensures that only one instantiation of each template is made.   |           | ✓           | ✓        | See 205          |

## Options that control the preprocessor

These options specify how the preprocessor runs.

Table 8. Summary of compiler options for preprocessor

| Option   | Description   | C Compile | C++ Compile | IPA Link | More Information |
|----------|---|-----------|-------------|----------|------------------|
| CONVLIT  | Turns on string literal codepage conversion.                            | ✓         | ✓           | ✓        | See 84           |
| DEFINE   | Defines preprocessor macro names.                                       | ✓         | ✓           | ✓        | See 94           |
| DIGRAPH  | Allows you to use additional digraphs in both C and C++ applications.   | ✓         | ✓           | ✓        | See 95           |
| LOCALE   | Specifies the locale to be used at compile time.                        | ✓         | ✓           | ✓        | See 148          |
| PPONLY   | Specifies that only the preprocessor is to be run and not the compiler. | ✓         | ✓           | ✓        | See 175          |
| UNDEFINE | Undefines preprocessor macro names.                                     | ✓         | ✓           | ✓        | See 213          |

## Options that control the processing of an input source file

These options allow you to control your z/OS XL C/C++ processing of an input source file.

Table 9. Summary of compiler options used for input source file processing control

| Option    | Description   | C Compile | C++ Compile | IPA Link | More Information |
|-----------|---|-----------|-------------|----------|------------------|
| HALT      | Specifies that the compiler stop processing files when it returns an error severity level of <i>n</i> or above.           | ✓         | ✓           | ✓        | See 113          |
| HALTONMSG | Instructs the compiler front end to stop after the translation phase when it encounters the specified <b>msg_number</b> . | ✓         | ✓           | ✓        | See 113          |
| MARGINS   | Identifies position of source to be scanned by the compiler.  | ✓         | ✓           | ✓        | See 158          |
| NESTINC   | Specifies the number of nested include files to be allowed.   | ✓         | ✓           | ✓        | See 163          |
| SEQUENCE  | Specifies the columns used for sequence numbers.  | ✓         | ✓           | ✓        | See 185          |

## Options that control the compiler listing

These options control the generation of a compiler listing, and the information that goes into the listing.

Table 10. Compiler Options That Control Listings

| Option    | Description  | C Compile | C++ Compile | IPA Link | More Information |
|-----------|--|-----------|-------------|----------|------------------|
| AGGREGATE | Lists structures and unions, and their sizes. The IPA Link step accepts but ignores this option. | ✓         |             | ✓        | See 68           |

Table 10. Compiler Options That Control Listings (continued)

| Option            | Description  | C Compile | C++ Compile | IPA Link | More Information |
|-------------------|--|-----------|-------------|----------|------------------|
| ATTRIBUTE         | For C++ compilations, generates a cross reference section showing attributes for each symbol and External Symbol Cross Reference section. For IPA Links, it also generates the Storage Offset Listing if IPA objects were created using the C compiler with XREF, IPA(ATTR), or IPA(XREF) options and the symbols for the current partition were not coalesced.  |           | ✓           | ✓        | See 76           |
| EXPMAC            | Lists all expanded macros. You must use the SOURCE option with EXPMAC.   | ✓         | ✓           | ✓        | See 103          |
| INLINE(,REPORT,,) | Generates a report on the status of inlined functions.   | ✓         | ✓           | ✓        | See 119          |
| INLRPT            | Generates a report on the status of inlined functions.   | ✓         | ✓           | ✓        | See 123          |
| IPA(MAP)          | Generates the following listing sections for the IPA Link step: Object File Map, Source File Map, Compiler Options Map, Global Symbols Map, Partition Map. This option only affects the IPA Link step.   | ✓         | ✓           | ✓        | See 124          |
| LIST              | Includes the object module in the compiler listing, in assembler-like code.  | ✓         | ✓           | ✓        | See 146          |
| OFFSET            | Lists offset addresses relative to entry points of functions. The LIST option must be used with OFFSET.  | ✓         | ✓           | ✓        | See 166          |
| SHOWINC           | Lists include files if SOURCE option is also specified.  | ✓         | ✓           | ✓        | See 187          |
| SOURCE            | Lists source file.   | ✓         | ✓           | ✓        | See 187          |
| SPLITLIST         | Enables the z/OS XL C/C++ compiler to write the IPA Link phase listing to multiple PDS members, PDSE members, or z/OS UNIX System Services files.  | ✓         | ✓           | ✓        | See 190          |
| XREF              | For C/C++, generates a cross-reference listing showing file/line definition, reference and modification information for each symbol. Also generates the External Symbol Cross Reference and Static Map. If you specify the XREF option for the IPA Link step, it generates an External Symbol Cross Reference listing section for each partition and Static Map. The IPA Link step creates a Storage Offset listing section if both of the following conditions are true: <ul style="list-style-type: none"> <li>You created your IPA objects with the C compiler and the XREF, IPA(ATTR), or IPA(XREF) option.</li> <li>If IPA did not coalesce the symbols for the current partition.</li> </ul> | ✓         | ✓           | ✓        | See 220          |

---

## Options that control the IPA object

These options control the content of the IPA object that is produced by the IPA Compile step.

Table 11. Compiler Options for IPA Object Control

| Option         | Description   | C Compile | C++ Compile | IPA Link | More Information |
|----------------|---|-----------|-------------|----------|------------------|
| IPA(ATTRIBUTE) | Saves information about symbol storage offsets in the IPA object file.  | ✓         | ✓           |          | See 124          |
| IPA(GONUMBER)  | Saves source line numbers in the IPA object file without generating line number tables. This option can be specified only for the IPA Compile step, if a combined conventional/IPA object file is requested.  | ✓         | ✓           |          | See 124          |
| IPA(LIST)      | Saves source line numbers in the IPA object file without generating a Pseudo Assembly listing. This option can only be specified for the IPA Compile step, if a combined conventional/IPA object file is requested.   | ✓         | ✓           |          | See 124          |
| IPA(OBJECT)    | Indicates whether a conventional (non-IPA)/IPA object is to be produced during the IPA Compile step.  | ✓         | ✓           |          | See 124          |
| IPA(OPTIMIZE)  | Generates information in the IPA object file that the compiler option OPT needs during IPA Link processing. IPA(OPTIMIZE) is the default setting. If you specify IPA(NOOPTIMIZE), IPA will change the option to IPA(OPTIMIZE) and issue an informational message. | ✓         | ✓           |          | See 124          |
| IPA(XREF)      | Saves information about symbol storage offsets in the IPA object file.  | ✓         | ✓           |          | See 124          |

---

## Options that control the IPA Link step

These options control the IPA Link step.

Table 12. Compiler options for IPA Link control

| Option  | Description  | C Compile | C++ Compile | IPA Link | More Information |
|---|--|-----------|-------------|----------|------------------|
| IPA(LEVEL(0   1   2   PDF1   PDF2   PDFNAME)) | Indicates the level of IPA optimization that the IPA Link step should perform after it links the object files into the call graph. | ✓         | ✓           | ✓        | See 127          |
| IPA(LINK)                                     | Instructs the compiler to perform IPA Link processing.   | ✓         | ✓           | ✓        | See 127          |



Table 12. Compiler options for IPA Link control (continued)

| Option      | Description  | C Compile | C++ Compile | IPA Link | More Information |
|-------------|--|-----------|-------------|----------|------------------|
| IPA(NCAL)   | Indicates whether library searches are performed during the IPA Link step to locate an object file or files that satisfy unresolved symbol references within the current set of object information. This suboption controls both explicit searches triggered by the LIBRARY IPA Link control statement, and the implicit SYSLIB search that occurs at the end of IPA Link step input processing. | ✓         | ✓           | ✓        | See 127          |
| IPA(UPCASE) | Determines whether an additional automatic library call pass is made for SYSLIB if unresolved references remain at the end of standard IPA Link step processing. Symbol matching is not case-sensitive in this pass.   | ✓         | ✓           | ✓        | See 127          |

## Options for debugging and diagnosing errors

These options help you to detect and correct errors in your z/OS XL C/C++ program.

Table 13. Compiler options for debugging and diagnostics

| Option   | Description   | C Compile | C++ Compile | IPA Link | More Information |
|----------|---|-----------|-------------|----------|------------------|
| CHECKOUT | Gives informational messages for possible programming errors. The IPA Link step accepts but ignores this option.  | ✓         |             | ✓        | See 78           |
| DEBUG    | Instructs the compiler to generate debug information.   | ✓         | ✓           |          | See 91           |
| EVENTS   | Produces an events file that contains error information and source file statistics. The IPA Link step accepts but ignores this option.                        | ✓         | ✓           | ✓        | See 101          |
| FLAG     | Specifies the lowest severity level to be listed.   | ✓         | ✓           | ✓        | See 105          |
| GONUMBER | Generates line number tables for Debug Tool and error trace backs. The TEST option turns on GONUMBER.   | ✓         | ✓           | ✓        | See 111          |
| INFO     | Generates informational messages.   | ✓         | ✓           |          | See 116          |
| IPA(DUP) | Indicates whether a message and a list of duplicate symbols are written to the console during the IPA Link step. This option only affects the IPA Link step.  | ✓         | ✓           | ✓        | See 124          |
| IPA(ER)  | Indicates whether a message and a list of unresolved symbols are written to the console during the IPA Link step. This option only affects the IPA Link step. | ✓         | ✓           | ✓        | See 124          |

Table 13. Compiler options for debugging and diagnostics (continued)

| Option             | Description  | C Compile | C++ Compile | IPA Link | More Information |
|--------------------|--|-----------|-------------|----------|------------------|
| PHASEID            | Causes each compiler module (phase) to issue an informational message which identifies the compiler phase module name, product identifier, and build level.  | ✓         | ✓           | ✓        | See 172          |
| SERVICE            | Places a string in the object module, which is displayed in the traceback if the application fails abnormally.   | ✓         | ✓           | ✓        | See 186          |
| SUPPRESS           | Prevents the batch compiler, or driver informational, or warning messages from being displayed or added to the listings.   | ✓         | ✓           | ✓        | See 198          |
| TERMINAL           | Directs diagnostic messages to be displayed on the terminal.   | ✓         | ✓           | ✓        | See 206          |
| TEST               | Generates information that Debug Tool needs to debug your program.   | ✓         | ✓           | ✓        | See 206          |
| WARN64             | Generates diagnostic messages for situations where compiling the source code with ILP32 and LP64 may produce different behavior. This option is designed to help you migrate a program to 64-bit mode. | ✓         | ✓           | ✓        | See 215          |
| XPLINK (BACKCHAIN) | Generates a prolog that saves information about the calling function in the called function stack frame. This facilitates debugging using storage dumps, at a cost in execution time.                  | ✓         | ✓           | ✓        | See 216          |
| XPLINK (STOREARGS) | Generates code to store arguments that are normally passed in registers to the argument area. This facilitates debugging using storage dumps, at a cost in execution time.                             | ✓         | ✓           | ✓        | See 216          |

## Options that control the programming language characteristics

These options allow you to control your z/OS XL C/C++ programming language characteristics.

Table 14. Summary of compiler options used for programming language characteristics control

| Option             | Description  | C Compile | C++ Compile | IPA Link | More Information |
|--------------------|--|-----------|-------------|----------|------------------|
| BITFIELD(UNSIGNED) | Specifies the default sign for bit fields.   | ✓         | ✓           | ✓        | See 77           |
| CHARS(UNSIGNED)    | Instructs the compiler to treat all variables of type char as either signed or unsigned.                             | ✓         | ✓           | ✓        | See 77           |
| KEYWORD            | Controls whether the specified name is created as a keyword or an identifier whenever it appears in your C++ source. |           | ✓           | ✓        | See 132          |
| LANGLVL            | Specifies the language standard to be used.  | ✓         | ✓           | ✓        | See 132          |

Table 14. Summary of compiler options used for programming language characteristics control (continued)

| Option       | Description   | C Compile | C++ Compile | IPA Link | More Information |
|--------------|---|-----------|-------------|----------|------------------|
| SSCOMM       | Allows comments to be specified by two slashes (/). The IPA Link step accepts but ignores this option.  | ✓         |             | ✓        | See 194          |
| STATICINLINE | Treats an inline function as static instead of extern.  |           | ✓           | ✓        | See 195          |
| TMPLPARSE    | Controls whether parsing and semantic checking are applied to template definition implementations (function bodies and static data member initializers) or only to template instantiations. |           | ✓           |          | See 210          |
| UPCONV       | Preserves <i>unsignedness</i> during z/OS XL C/C++ type conversions. The IPA Link step accepts but ignores this option.   | ✓         |             | ✓        | See 214          |

## Options that control object code generation

These options are used to control how your z/OS XL C/C++ object code is produced.

Table 15. Summary of compiler options used for object code control

| Option       | Description   | C Compile | C++ Compile | IPA Link | More Information |
|--------------|---|-----------|-------------|----------|------------------|
| AGGRCOPY     | Instructs the compiler whether or not the source and destination in structure assignments can overlap. (They cannot overlap according to ISO Standard C rules.)   | ✓         | ✓           | ✓        | See 67           |
| ALIAS        | Generates ALIAS binder control statements for each required entry point.  | ✓         |             | ✓        | See 68           |
| ANSIALIAS    | Indicates to the compiler that the code strictly follows the type-based aliasing rule in the ISO C and C++ standards, and can therefore be compiled with higher performance optimization of the generated code. | ✓         | ✓           | ✓        | See 69           |
| ARCHITECTURE | Specifies the architecture for which the executable program instructions are to be generated.   | ✓         | ✓           | ✓        | See 72           |
| ASCII        | Provides native ASCII/NLS support.  | ✓         | ✓           | ✓        | See 75           |
| CICS         | Enables CICS statements to be embedded in C/C++ source and passes them through the compiler without the need for an explicit preprocessing step.  | ✓         | ✓           | ✓        | See 80           |
| COMPACT      | Controls choices made between those optimizations which tend to result in faster but larger code and those which tend to result in smaller but slower code.   | ✓         | ✓           | ✓        | See 82           |

Table 15. Summary of compiler options used for object code control (continued)

| Option     | Description   | C Compile | C++ Compile | IPA Link | More Information |
|------------|---|-----------|-------------|----------|------------------|
| COMPRESS   | Suppresses the generation of function names in the function control block, thereby reducing the size of your application's load module.                                     | ✓         | ✓           | ✓        | See 83           |
| CSECT      | Instructs the compiler to generate CSECT names in the output object module.   | ✓         | ✓           | ✓        | See 86           |
| CVFT       | Shrinks the size of the writeable static area (WSA) and reduces the size of construction virtual function tables (CVFT), which in turn reduces the load module size.        |           | ✓           |          | See 89           |
| DLL        | Generates object code for DLLs or DLL applications.   | ✓         | ✓           | ✓        | See 97           |
| ENUMSIZE   | Specifies the amount of storage occupied by enumerations  | ✓         | ✓           | ✓        | See 99           |
| EXH        | Controls the generation of C++ exception handling code.   |           | ✓           |          | See 103          |
| EXPORTALL  | Exports all externally defined functions and variables.   | ✓         | ✓           | ✓        | See 104          |
| FLOAT      | Switches floating-point representation between IEEE and hexadecimal.  | ✓         | ✓           | ✓        | See 106          |
| GOFF       | Instructs the compiler to produce an object file in the Generalized Object File Format.   | ✓         | ✓           | ✓        | See 111          |
| HGPR       | Enables the compiler to exploit 64-bit General Purpose Registers (GPRs) in 32-bit programs, which run on z/Architecture hardware.   | ✓         | ✓           | ✓        | See 114          |
| HOT        | Enables the compiler to request high-order transformations on loops during optimization, which gives you the ability to generate more highly optimized code.                | ✓         | ✓           |          | See 114          |
| IGNERRNO   | Informs the compiler that your application is not using ERRNO, allowing the compiler to explore additional optimization opportunities for library functions in LIBANSI.     | ✓         | ✓           | ✓        | See 115          |
| INITAUTO   | Directs the compiler to generate code to initialize automatic variables. Automatic variables require storage only while the function in which they are declared are active. | ✓         | ✓           | ✓        | See 118          |
| INLINE     | Inlines user functions into source and helps maximize optimization.   | ✓         | ✓           | ✓        | See 119          |
| IPA        | Instructs the compiler to perform Interprocedural Analysis (IPA) processing.  | ✓         | ✓           | ✓        | See 124          |
| IPA(LEVEL) | Indicates the level of IPA optimization that the IPA Link step should perform.  | ✓         | ✓           | ✓        | See 124          |

Table 15. Summary of compiler options used for object code control (continued)

| Option           | Description   | C Compile | C++ Compile | IPA Link | More Information |
|------------------|---|-----------|-------------|----------|------------------|
| LIBANSI          | Indicates whether or not functions with the name of an ANSI C library function are in fact ANSI C library functions.  | ✓         | ✓           | ✓        | See 145          |
| LONGNAME         | Provides support for external names of mixed case and up to 1024 characters long.   | ✓         | ✓           | ✓        | See 149          |
| LP64             | Instructs the compiler to generate code that runs on a 64-bit architecture machine.   | ✓         | ✓           | ✓        | See 150          |
| MAXMEM           | Limits the amount of memory used for local tables of specific, memory intensive optimization.   | ✓         | ✓           | ✓        | See 159          |
| NAMEMANGLING     | Enables the encoding of variable names into unique names so that linkers can separate common names in the language.   |           | ✓           | ✓        | See 161          |
| OBJECT           | Produces an object module, and stores it in the file that you specify, or in the data set associated with SYSLIN.   | ✓         | ✓           | ✓        | See 163          |
| OBJECTMODEL      | Sets the type of object model.  | ✓         | ✓           | ✓        | See 165          |
| OPTIMIZE         | Improves run-time performance by introducing optimizations during code generation.  | ✓         | ✓           | ✓        | See 169          |
| RENT             | Generates reentrant code. The IPA Link step accepts but ignores this option.  | ✓         |             | ✓        | See 178          |
| ROCONST          | Informs the compiler that the const qualifier is respected by the program so that variables defined with the const keyword are not be overridden (for example, by a casting operation). | ✓         | ✓           | ✓        | See 179          |
| ROSTRING         | Informs the compiler that string literals are read-only.  | ✓         | ✓           | ✓        | See 181          |
| ROUND            | Sets the rounding mode for binary floating point numbers.   | ✓         | ✓           | ✓        | See 182          |
| SPILL            | Specifies the size of the spill area to be used for compilation.  | ✓         | ✓           | ✓        | See 188          |
| SQL              | Enables the compiler to process embedded SQL statements.  | ✓         | ✓           | ✓        | See 193          |
| START            | Generates a CEESTART whenever necessary.  | ✓         | ✓           | ✓        | See 195          |
| STRICT           | Affects the precision of floating point calculations.   | ✓         | ✓           | ✓        | See 196          |
| STRICT_INDUCTION | Instructs the compiler to disable loop induction variable optimizations.  | ✓         | ✓           | ✓        | See 197          |
| TARGET           | Generates an object module for the targeted operating system or run-time library.   | ✓         | ✓           | ✓        | See 198          |
| TUNE             | Specifies the architecture for which the executable program will be optimized.  | ✓         | ✓           | ✓        | See 211          |

Table 15. Summary of compiler options used for object code control (continued)

| Option  | Description  | C Compile | C++ Compile | IPA Link | More Information |
|---------|--|-----------|-------------|----------|------------------|
| UNROLL  | Determines whether or not unrolling is allowed on any loops in a specified program.  | ✓         | ✓           | ✓        | See 213          |
| WSIZEOF | Causes the size of operator to return the widened size for function return types.  | ✓         | ✓           | ✓        | See 215          |
| XPLINK  | Instructs the compiler to generate extra performance linkage for function calls. XPLINK(CALLBACK) specifies that all calls via function pointers will be considered potentially incompatible, and fix-up code will be inserted by the compiler to assist the call. | ✓         | ✓           | ✓        | See 216          |

## Options that control program execution

These options control the execution of your program

Table 16. Summary of compiler options for program execution

| Option   | Description  | C Compile | C++ Compile | IPA Link | More Information |
|----------|--|-----------|-------------|----------|------------------|
| ARGPARSE | Parses arguments provided on the invocation line.  | ✓         | ✓           | ✓        | See 74           |
| ASCII    | Provides ASCII/NLS support.  | ✓         | ✓           | ✓        | See 75           |
| EXECOPS  | Allows you to specify run-time options on the invocation line.   | ✓         | ✓           | ✓        | See 102          |
| PLIST    | Specifies that the original operating system parameter list should be available.                                 | ✓         | ✓           | ✓        | See 173          |
| REDIR    | Allows redirection of stderr, stdin, and stdout from the invocation line.  | ✓         | ✓           | ✓        | See 178          |
| RTTI     | Generates run-time type identification (RTTI) information for the typeid operator and the dynamic_cast operator. |           | ✓           | ✓        | See 183          |
| TARGET   | Generates an object module for the targeted operating system or run-time library.                                | ✓         | ✓           | ✓        | See 198          |

## Portability options

These options allow you to port your C++ code to the z/OS XL C++ compiler.

Table 17. Summary of compiler options for portability

| Option | Description   | C Compile | C++ Compile | IPA Link | More Information |
|--------|---|-----------|-------------|----------|------------------|
| PORT   | Adjusts the error recovery action that the compiler takes when it encounters an ill-formed <b>#pragma pack</b> directive. |           | ✓           |          | See 174          |

---

## Description of compiler options

The following sections describe the compiler options and their usage. Compiler options are listed alphabetically. Syntax diagrams show the abbreviated forms of the compiler options.

The "Default", which is the default compiler option for the z/OS XL C/C++ compiler (batch and TSO environments), is listed at the top of each compiler option description.

Each compiler option description that follows includes an Option Scope table. The following Option Scope table is an example that shows that, in this case, the compiler option is supported by both the C compiler and the C++ compiler. The table also shows that, in this case, the compiler option is accepted by the IPA Link step.

| Option Scope |             |          |
|--------------|-------------|----------|
| C Compile    | C++ Compile | IPA Link |
| ✓            | ✓           | ✓        |

## AGGRCOPY

Default: AGGRCOPY(NOOVERLAP)

| Option Scope |             |          |
|--------------|-------------|----------|
| C Compile    | C++ Compile | IPA Link |
| ✓            | ✓           | ✓        |

**Category:** Object Code Control



The AGGRCOPY option instructs the compiler on whether or not the source and destination assignments for structures can overlap. They cannot overlap according to ISO Standard C rules. For example, in the assignment `a = b;`, where `a` and `b` are structs, `a` is the destination and `b` is the source.

In the case of structure assignments, the compiler can generate faster code if no overlap is assumed. The OVERLAP suboption specifies that the source and destination in a structure assignment might overlap. The NOOVERLAP option specifies that they do not, and that the compiler can assume this when generating code.

### Effect on IPA Compile step

The IPA Compile step generates information for the IPA Link step. The AGGRCOPY option affects the regular object module if you requested one by specifying the IPA(OBJECT) option.

### Effect on IPA Link step

The IPA Link step accepts the AGGRCOPY option, but ignores it.

The IPA Link step merges and optimizes the application code, and then divides it into sections for code generation. Each of these sections is a partition. The IPA Link step uses information from the IPA Compile step to determine if a subprogram can be placed in a particular partition. Only compatible subprograms are included in a given partition.

The value of the AGGRCOPY option for a partition is set to the value of the first subprogram that is placed in the partition. During IPA inlining, subprograms with different AGGRCOPY settings may be combined in the same partition. When this occurs, the resulting partition is always set to AGGRCOPY(OVERLAP).

## AGGREGATE | NOAGGREGATE

Default: NOAGGREGATE

For the z/OS UNIX System Services utilities, the default for a regular compile is NOAGGREGATE. To specify AGGREGATE, you must specify -V.

| Option Scope |             |          |
|--------------|-------------|----------|
| C Compile    | C++ Compile | IPA Link |
| ✓            |             | ✓        |

**Category:** Listing



The AGGREGATE option instructs the compiler to include a layout of all struct or union types in the compiler listing. Depending on the struct or union declaration, the maps are generated as follows:

- If the typedef name refers to a struct or union, one map is generated for the struct or union for which the typedef name refers to. If the typedef name can be qualified with the `_Packed` keyword, then a packed layout of the struct or union is generated as well. Each layout map contains the offset and lengths of the structure members and the union members. The layout map is identified by the struct/union tag name (if one exists) and by the typedef names.
- If the struct or union declaration has a tag, two maps are created: one contains the unpacked layout, and the other contains the packed layout. The layout map is identified by the struct/union tag name.
- If the struct or union declaration does not have a tag, one map is generated for the struct or union declared. The layout map is identified by the variable name that is specified on the struct or union declaration.

You can specify this option using the `#pragma options` directive for C.

## ALIAS | NOALIAS

Default: NOALIAS

| Option Scope |             |          |
|--------------|-------------|----------|
| C Compile    | C++ Compile | IPA Link |
| ✓            |             | ✓        |



**Category:** Object Code Control



The ALIAS option generates ALIAS control statements that help the binder locate modules in a load library. The suboption *name* is assigned to the NAME control statement.

- ALIAS(*name*) If you specify ALIAS(*name*), the compiler generates the following:
- Control statements in the object module.
  - A NAME control statement in the form NAME *name* (R). R indicates that the binder should replace the member in the library with the new member.

The compiler generates one ALIAS control statement for every external entry point that it encounters during compilation. These control statements are then appended to the object module.

ALIAS If you specify ALIAS with no suboption, the compiler selects an existing CSECT name from the program, and nominates it on the NAME statement.

ALIAS() If you use an empty set of parentheses, ALIAS(), or specify NOALIAS, the compiler does not generate a NAME control statement.

NOALIAS If you specify NOALIAS, the compiler does not generate a NAME control statement. NOALIAS has the same effect as ALIAS().

If you specify the ALIAS option with LONGNAME, the compiler does not generate an ALIAS control statement.

For complete details on ALIAS and NAME control statements, see *z/OS MVS Program Management: User's Guide and Reference*.

You can specify this option using the **#pragma options** directive for C.

## ANSIALIAS | NOANSIALIAS

Default: ANSIALIAS

The **cc** compiler invocation command for a regular compile in the z/OS UNIX System Services environment uses NOANSIALIAS as the default option.

| Option Scope |             |          |
|--------------|-------------|----------|
| C Compile    | C++ Compile | IPA Link |
| ↙            | ↙           | ↙        |

**Category:** Object Code Control



The ANSIALIAS option indicates to the compiler that the code strictly follows the type-based aliasing rules in the ISO C and C++ standards, and can therefore be compiled with higher performance optimization of the generated code. When type-based aliasing is used during optimization, the optimizer assumes that pointers can only be used to access objects of the same type.

Type-based aliasing improves optimization in the following ways.

- It provides precise knowledge of what pointers can and cannot point at.
- It allows more loads to memory to be moved up and stores to memory moved down past each other, which allows the delays that normally occur in the original written sequence of statements to be overlapped with other tasks. These re-arrangements in the sequence of execution increase parallelism, which is desirable for optimization.
- It allows the removal of some loads and stores that otherwise might be needed in case those values were accessed by unknown pointers.
- It allows more identical calculations to be recognized ("commoning").
- It allows more calculations that do not depend on values modified in a loop to be moved out of the loop ("code motion").
- It allows better optimization of parameter usage in inlined functions.

Simplified, the rule is that you cannot safely dereference a pointer that has been cast to a type that is not closely related to the type of what it points at. The ISO C and C++ standards define the closely related types.

The following are not subject to type-based aliasing:

- Types that differ only in reference to whether they are signed or unsigned. For example, a pointer to a signed int can point to an unsigned int.
- Character pointer types (char, unsigned char, and in C but not C++ signed char).
- Types that differ only in their const or volatile qualification. For example, a pointer to a const int can point to an int.
- C++ types where one is a class derived from the other.

z/OS XL C/C++ compilers often expose type-based aliasing violations that other compilers do not. The C++ compiler corrects most but not all suspicious and incorrect casts without warnings or informational messages. For examples of aliasing violations that are detected and quietly fixed by the compiler, see the discussion of the reinterpret\_cast operator in the *z/OS XL C/C++ Language Reference*.

In addition to the specific optimizations to the lines of source code that can be obtained by compiling with the ANSIALIAS compiler option, other benefits and advantages, which are at the program level, are described below:

- It reduces the time and memory needed for the compiler to optimize programs.
- It allows a program with a few coding errors to compile with optimization, so that a relatively small percentage of incorrect code does not prevent the optimized compilation of an entire program.
- It positively affects the long-term maintainability of a program by supporting ISO-compliant code.

It is important to remember that even though a program compiles, its source code may not be completely correct. When you weigh tradeoffs in a project, the short-term expedience of getting a successful compilation by forgoing performance optimization should be considered with awareness that you may be nurturing an

incorrect program. The performance penalties that exist today could worsen as the compilers that base their optimization on strict adherence to ISO rules evolve in their ability to handle increased parallelism.

If you specify `NOANSIALIAS`, the optimizer assumes that a given pointer of a given type can point to an external object or any object whose address is taken, regardless of type. This assumption creates a larger aliasing set at the expense of performance optimization.

For C, the `CHECKOUT(CAST)` compiler option can help you locate some but not all suspicious casts and `ANSIALIAS` violations.

The following example executes as expected when compiled unoptimized or with the `NOANSIALIAS` option; it successfully compiles optimized with `ANSIALIAS`, but does not necessarily execute as expected. On non-IBM compilers, the following code may execute properly, even though it is incorrect.

```
1 extern int y = 7.;
2
3 void main() {
4     float x;
5     int i;
6     x = y;
7     i = *(int *) &x;
8     printf("i=%d. x=%f.\n", i, x);
9 }
```

In the example above, the value in object `x` of type `float` has its stored value accessed via the expression `*(int *) &x`. The access to the stored value is done by the `*` operator, operating on the expression `(int *) &x`. The type of that expression is `(int *)`, which is not covered by the list of valid ways to access the value in the ISO standard, so the program violates the standard.

When `ANSIALIAS` (the default) is in effect, you are making a promise to the compiler that your source code obeys the constraints in the ISO standard. On the basis of using this compiler option, the compiler front end passes aliasing information to the optimizer that, in this case, an object of type `float` could not possibly be pointed to by an `(int *)` pointer (that is, that they could not be aliases for the same storage). The optimizer believes this promise and performs optimization accordingly. When it compares the instruction that stores into `x` and the instruction that loads out of `*(int *)`, it believes it is safe to put them in either order. Doing the load before the store will make the program run faster, so it interchanges them. The program becomes equivalent to:

```
1 extern int y = 7.;
2
3 void main() {
4     float x;
5     int i;
6     int temp;
7     temp = *(int *) &x; /* uninitialized */
8     x = y;
9     i = temp;
10    printf("i=%d. x=%f.\n", i, x);
11 }
```

The value stored into variable `i` is the old value of `x`, before it was initialized, instead of the new value that was intended. IBM compilers apply some optimizations more aggressively than some other compilers so correctness is more important.

**Notes:**

1. This option only takes effect if the OPTIMIZE option is in effect.
2. If you specify LANGLVL(COMMONC), the ANSIALIAS option is automatically turned off. If you want ANSIALIAS turned on, you must explicitly specify it. Using LANGLVL(COMMONC) and ANSIALIAS together may have undesirable effects on your code at a high optimization level. See “LANGLVL” on page 132 for more information on LANGLVL(COMMONC).
3. A comment that indicates the ANSIALIAS option setting is generated in your object module to aid you in diagnosing a problem with your program.
4. Although type-based aliasing does not apply to the volatile and const qualifiers, these qualifiers are still subject to other semantic restrictions. For example, casting away a const qualifier might lead to an error at run time.

See “CHECKOUT | NOCHECKOUT” on page 78 to see how to obtain more diagnostic information.

You can specify this option using the **#pragma options** directive for C.

**Effect on IPA Link step**

If the ANSIALIAS option is specified, then the IPA Link step phase will take advantage of the knowledge that the program will adhere to the standard C/C++ aliasing rules in order to improve its variable aliasing calculations.

**ARCHITECTURE**

Default: ARCH(5) for TARGET(zOSV1R6) and above and ARCH(2) for TARGET(zOSV1R4) to TARGET(zOSV1R5)

| Option Scope |             |          |
|--------------|-------------|----------|
| C Compile    | C++ Compile | IPA Link |
| ✔            | ✔           | ✔        |

**Category:** Object Code Control

►► ARCH—(—n—)—————►►

The ARCH option selects the instruction set available during the code generation of your program based on the specified machine architecture. Specifying a higher ARCH level generates code that uses newer and faster instructions instead of the sequences of common instructions. A subparameter specifies the group to which a model number belongs. Note that your application will not run on a lower architecture processor than what you specified using the ARCH option. Use the ARCH level that matches the lowest machine architecture where your program will run.

Use the ARCH option in conjunction with the TUNE option. For more information on the interaction between ARCH and TUNE, see “TUNE” on page 211.

If you specify a group that does not exist or is not supported, the compiler uses the default, and issues a warning message.

Current groups of models that are supported include the following:

- 0 Produces code that is executable on all models.

- 1 Produces code that uses instructions available on the following system machine models:
  - 9021-520, 9021-640, 9021-660, 9021-740, 9021-820, 9021-860, and 9021-900
  - 9021-xx1 and 9021-xx2
  - 9672-Rx1, 9672-Rx2 (G1), 9672-Exx, and 9672-Pxx

Specifically, these ARCH(1) machines and their follow-ons add the C Logical String Assist hardware instructions. These instructions are exploited by the compiler, when practical, for a faster and more compact implementation of some functions, for example, `strcmp()`.

- 2 It produces code that uses instructions available on the following system machine models:
  - 9672-Rx3 (G2), 9672-Rx4 (G3), 9672-Rx5 (G4), and 2003

Specifically, these ARCH(2) machines and their follow-ons add the Branch Relative instruction (Branch Relative and Save - BRAS), and the halfword Immediate instruction set (for example, Add Halfword Immediate - AHI) which may be exploited by the compiler for faster processing.

- 3 Produces code that uses instructions available on the 9672-xx6 (G5), 9672-xx7 (G6), and follow-on models.

Specifically, these ARCH(3) machines and their follow-ons add a set of facilities for IEEE floating-point representation, as well as 12 additional floating-point registers and some new floating-point support instructions that may be exploited by the compiler.

Note that ARCH(3) is required for execution of a program that specifies the `FLOAT(IEEE)` compiler option. However, if the program is executed on a physical processor that does not actually provide these ARCH(3) facilities, any program check (operation or specification exception), resulting from an attempt to use features associated with IEEE floating point or the additional floating point registers, will be intercepted by the underlying OS/390 V2R6 or higher operating system, and simulated by software. There will be a significant performance degradation for the simulation.

- 4 Produces code that uses instructions available on model 2064-100 (z/900) in ESA/390 mode.

Specifically, the following instructions are used for long long operations:

- 32-bit Add-With-Carry (ALC, ALCR) for long long addition (rather than requiring a branch sequence)
- 32-bit Subtract-With-Borrow (SLB, SLBR) for long long subtraction (rather than requiring a branch sequence)
- Inline sequence with 32-bit Multiply-Logical (ML, MLR) for long long multiplication (rather than calling `@MULI64`)

- 5 Is the default value. Produces code that uses instructions available on model 2064-100 (z/900) in z/Architecture mode.

Specifically, this is required for execution of a program in 64-bit mode. If you specify the `LP64` compiler option, the compiler will use ARCH(5) as the default. If you explicitly set ARCH to a lower level, the compiler will issue a warning and ignore your setting. ARCH(5) specifies the target machine architecture and the application can be either 31-bit or 64-bit.

- 6 Produces code that uses instructions available on the 2084-xxx models in z/Architecture mode.

Specifically, these ARCH(6) machines and their follow-ons add the long-displacement facility. For further information on the long-displacement facility, refer to *z/Architecture Principles of Operation*.

- 7 Produces code that uses instructions available on the 109 models (IBM System z9™) in z/Architecture mode.

Specifically, these ARCH(7) machines and their follow-ons add instructions supported by facilities such as extended-immediate and extended translation facilities, which may be exploited by the compiler. For further information on these facilities, refer to *z/Architecture Principles of Operation*.

**Notes:**

1. Code that is compiled at ARCH(1) runs on machines in the ARCH(1) group and later machines, including those in the ARCH(2) and ARCH(3) groups. It may not run on earlier machines. Code that is compiled at ARCH(2) may not run on ARCH(1) or earlier machines. Code that is compiled at ARCH(3) may not run on ARCH(2) or earlier machines.
2. For the above system machine models, x indicates any value. For example, 9672-Rx4 means 9672-RA4 through to 9672-RX4, not just 9672-RX4.

You can specify this option using the **#pragma options** directive for C.

**Effect on IPA Compile step**

If you specify the ARCHITECTURE option for any compilation unit in the IPA Compile step, the compiler generates information for the IPA Link step. This option also affects the regular object module if you request one by specifying the IPA(OBJECT) option.

**Effect on IPA Link step**

The IPA Link step merges and optimizes the application code, and then divides it into sections for code generation. Each of these sections is a partition.

If you specify the ARCH option on the IPA Link step, it uses the value of that option for all partitions. The IPA Link step Prolog and all Partition Map sections of the IPA Link step listing display that value.

If you do not specify the option on the IPA Link step, the value used for a partition depends on the value that you specified for the IPA Compile step for each compilation unit that provided code for that partition. If you specified the same value for each compilation unit, the IPA Link step uses that value. If you specified different values, the IPA Link step uses the lowest level of ARCH.

The level of ARCH for a partition determines the level of TUNE for the partition. For more information on the interaction between ARCH and TUNE, see “TUNE” on page 211.

The Partition Map section of the IPA Link step listing, and the object module display the final option value for each partition. If you override this option on the IPA Link step, the Prolog section of the IPA Link step listing displays the value of the option.

The Compiler Options Map section of the IPA Link step listing displays the option value that you specified for each IPA object file during the IPA Compile step.

## ARGPARSE | NOARGPARSE

Default: ARGPARSE

| Option Scope |             |          |
|--------------|-------------|----------|
| C Compile    | C++ Compile | IPA Link |
| ✓            | ✓           | ✓        |

**Category:** Program Execution

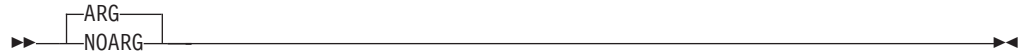

The ARGPARSE option specifies that the arguments supplied to your program on the invocation line are parsed and passed to the `main()` routine in the C argument format, commonly `argc` and `argv`. `argc` contains the argument count, and `argv` contains the tokens after the command processor has parsed the string.

If you specify NOARGPARSE, arguments on the invocation line are not parsed. `argc` has a value of 2, and `argv` contains a pointer to the string.

**Note:** If you specify NOARGPARSE, you cannot specify REDIR. The compiler will turn off REDIR with a warning since the whole string on the command line is treated as an argument and put into `argv`.

This option has no effect under CICS.

### Effect on IPA Compile step

If you specify ARGPARSE for any compilation unit in the IPA Compile step, the compiler generates information for the IPA Link step. This option also affects the regular object module if you request one by specifying the IPA(OBJECT) option.

### Effect on IPA Link step

If you specify this option for both the IPA Compile and the IPA Link steps, the setting on the IPA Link step overrides the setting on the IPA Compile step. This applies whether you use ARGPARSE and NOARGPARSE as compiler options, or specify them using the **#pragma runopts** directive on the IPA Compile step.

If you specified ARGPARSE on the IPA Compile step, you do not need to specify it again on the IPA Link step to affect that step. The IPA Link step uses the information generated for the compilation unit that contains the `main()` function. If it cannot find a compilation unit that contains `main()`, it uses the information generated by the first compilation unit that it finds.

## ASCII | NOASCII

Default: NOASCII

| Option Scope |             |          |
|--------------|-------------|----------|
| C Compile    | C++ Compile | IPA Link |
| ✓            | ✓           | ✓        |

**Category:** Object Code Control and Program Execution





The ASCII option instructs the compiler to perform the following:

- Use XPLink linkage unless explicitly overwritten by the NOXPLINK option. Note that the ASCII run-time functions require XPLINK. The system headers check the `__XPLINK__` macro (which is predefined when the XPLINK option is turned on). The prototypes for the ASCII run-time functions will not be exposed under NOXPLINK. Specifying the NOXPLINK option explicitly will prevent you from using the ASCII run-time functions. ASCII NOXPLINK will be accepted, and will generate an error (CCN8136) if there is a `main()` in the code (an executable to be generated).
- Use ISO8859-1 for its default codepage rather than IBM-1047 for character constants and string literals.
- Set a flag in the program control block to indicate that the compile unit is ASCII.
- Pre-define the macro `__CHARSET_LIB` for use in header files.

Use the ASCII option and the ASCII version of the run-time library if your application must process ASCII data natively at execution time.

**Note:** You can use EBCDIC instead of NOASCII. The two names are synonymous. There is no negative form for EBCDIC, which means that NOEBCDIC is not supported. Since EBCDIC is the default, there is usually no need to specify it. If you must specify it, use EBCDIC instead of NOASCII as the former is self-documenting.

## ATTRIBUTE | NOATTRIBUTE

Default: NOATTRIBUTE

In the z/OS UNIX System Services environment, this option is turned on by specifying `-V` when using the `cx` command.

| Option Scope |             |          |
|--------------|-------------|----------|
| C Compile    | C++ Compile | IPA Link |
|              | ✓           | ✓        |

**Category:** Listing



The ATTRIBUTE option produces a Cross Reference listing that shows the attributes for each symbol, an External Symbol Cross Reference section, and Static Map section.

The ATTRIBUTE(FULL) option produces a listing of all identifiers that are found in your code, even those that are not referenced. The compiler writes the listing produced by ATTRIBUTE or ATTRIBUTE(FULL) to a listing file.

The NOATTRIBUTE option suppresses the attribute listing.



### Effect on IPA Compile step

During the IPA Compile step, the compiler saves symbol storage offset information in the IPA object file as follows:

- For C, if you specify the XREF, IPA(ATTRIBUTE), or IPA(XREF) options or the **#pragma options(XREF)**
- For C++, if you specify the ATTR, XREF, IPA(ATTRIBUTE), or IPA(XREF) options

If regular object code/data is produced using the IPA(OBJECT) option, the cross reference sections of the compile listing will be controlled by the ATTR and XREF options.

### Effect on IPA Link step

If you specify the ATTR or XREF options for the IPA Link step, it generates External Symbol Cross Reference and Static Map listing sections for each partition.

The IPA Link step creates a Storage Offset listing section if during the IPA Compile step you requested the additional symbol storage offset information for your IPA objects.

## BITFIELD(SIGNED) | BITFIELD(UNSIGNED)

Default: BITFIELD(UNSIGNED)

| Option Scope |             |          |
|--------------|-------------|----------|
| C Compile    | C++ Compile | IPA Link |
| ✓            | ✓           | ✓        |

**Category:** Programming Language Characteristics Control

▶▶ BITFIELD (  $\begin{matrix} \text{UNSIGNED} \\ \text{SIGNED} \end{matrix}$  ) ▶▶

The BITFIELD compiler option instructs the compiler to treat all bit fields by default as either signed or unsigned.

## CHARS(SIGNED) | CHARS(UNSIGNED)

Default: CHARS(UNSIGNED)

| Option Scope |             |          |
|--------------|-------------|----------|
| C Compile    | C++ Compile | IPA Link |
| ✓            | ✓           | ✓        |

**Category:** Programming Language Characteristics Control

▶▶ CHARS (  $\begin{matrix} \text{UNSIGNED} \\ \text{SIGNED} \end{matrix}$  ) ▶▶

The CHARS compiler option instructs the compiler to treat all variables of type char as either signed or unsigned. This option has the same effect as the **#pragma chars** directive, which takes precedence over the compiler option. See *z/OS XL C/C++ Language Reference* for more information on this directive.

# CHECKOUT | NOCHECKOUT

Default: NOCHECKOUT

| Option Scope |             |          |
|--------------|-------------|----------|
| C Compile    | C++ Compile | IPA Link |
| ✓            |             | ✓        |

**Category:** Debug/Diagnostic

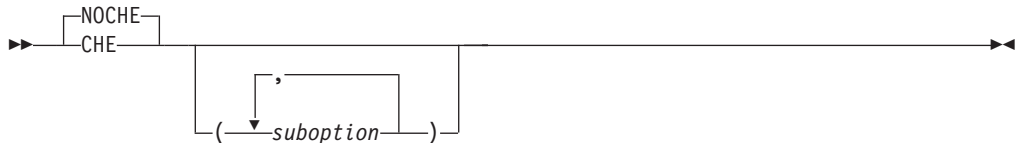

where:

*subopts* is one of the suboptions that are shown in Table 18.

**Note:** As of z/OS V1R6, the INFO option is supported for both C and C++ so you may prefer to use INFO instead of CHECKOUT.

The CHECKOUT option instructs the compiler to produce additional informational messages that can indicate possible programming errors. The messages can help you to debug your C programs.

You can specify CHECKOUT with or without suboptions. If you include suboptions, you can specify any number with commas between them. If you do not include suboptions, the compiler uses the default for CHECKOUT at your installation.

This table lists the CHECKOUT suboptions, their abbreviations, and the messages they generate.

**Note:** Default CHECKOUT suboptions are underlined.

Table 18. CHECKOUT suboptions, abbreviations, and descriptions

| CHECKOUT Suboption | Abbreviated Name | Description   |
|--------------------|------------------|---|
| <u>ACCURACY</u>    | AC   NOAC        | Assignments of long values to variables that are not long |
| <u>NOACCURACY</u>  |                  |   |

Table 18. CHECKOUT suboptions, abbreviations, and descriptions (continued)

| CHECKOUT Suboption          | Abbreviated Name | Description  |
|-----------------------------|------------------|--|
| <u>CAST</u>   NOCAST        | CA   NOCA        | Potential violation of ANSI type-based aliasing rules in explicit pointer type castings. Implicit conversions, for example, those due to assignment statements, are already checked with a warning message for incompatible pointer types. See “ANSIALIAS   NOANSIALIAS” on page 69 for more information on ANSI type-based aliasing. Also see “DLL   NODLL” on page 97 for DLL function pointer casting restrictions. |
| <u>ENUM</u>   NOENUM        | EN   NOEN        | Usage of enumerations  |
| <u>EXTERN</u>   NOEXTERN    | EX   NOEX        | Unused variables that have external declarations   |
| <u>GENERAL</u>   NOGENERAL  | GE   NOGE        | General checkout messages  |
| <u>GOTO</u>   NOGOTO        | GO   NOGO        | Appearance and usage of goto statements  |
| <u>INIT</u>   NOINIT        | I   NOI          | Variables that are not explicitly initialized  |
| <u>PARAM</u>   NOPARM       | PAR   NOPAR      | Function parameters that are not used  |
| <u>PORT</u>   NOPORT        | POR   NOPOR      | Non-portable usage of the z/OS XL C language   |
| <u>PPCHECK</u>   NOPPCHECK  | PPC   NOPPC      | All preprocessor directives  |
| <u>PPTRACE</u>   NOPPTTRACE | PPT   NOPPT      | Tracing of include files by the preprocessor   |
| <u>TRUNC</u>   NOTRUNC      | TRU   NOTRU      | Variable names that are truncated by the compiler  |
| ALL                         | ALL              | Turns on all of the suboptions for CHECKOUT  |
| NONE                        | NONE             | Turns off all of the suboptions for CHECKOUT   |

You can specify the CHECKOUT option on the invocation line and using the **#pragma options** preprocessor directive for C. When you use both methods at the same time, the options are merged. If an option on the invocation line conflicts with an option in the **#pragma options** directive, the option on the invocation line takes precedence. The following examples illustrate these rules.

**Source file:**

```
#pragma options (NOCHECKOUT(NONE,ENUM))
```

**Invocation line:**

```
CHECKOUT (GOTO)
```

**Result:**

```
CHECKOUT (NONE,ENUM,GOTO)
```

**Source file:**

**#pragma options (NOCHECKOUT(NONE,ENUM))**

**Invocation line:**

CHECKOUT (ALL,NOENUM)

**Result:**

CHECKOUT (ALL,NOENUM)

**Note:** If you used the CHECKOUT option and did not receive an informational message, ensure that the setting of the FLAG option is FLAG(I)

Suboptions that are specified in a **#pragma options(NOCHECKOUT(subopts))** directive, or NOCHECKOUT(subopts), apply if CHECKOUT is specified on the command line.

You can turn the CHECKOUT option off for certain files or statements of your source program by using a **#pragma checkout(suspend)** directive. Refer to *z/OS XL C/C++ Language Reference* for more information regarding this pragma directive.

**Note:** See the “INFO | NOINFO” on page 116 compiler option section for information on C++ support for similar functionality.

## CICS | NOCICS

Default: NOCICS

| Option Scope |             |          |
|--------------|-------------|----------|
| C Compile    | C++ Compile | IPA Link |
| ✓            | ✓           | ✓        |

**Category:** Object Code Control

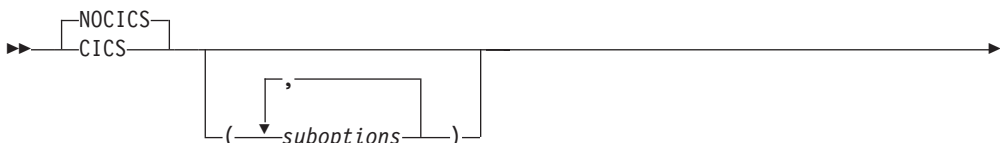

Integrated CICS translation enables you to embed CICS statements in C/C++ source and pass them through the compiler without the need for an explicit preprocessing step. This permits a more seamless operation of C/C++ within the CICS environment, especially under UNIX System Services, and may help with program readability and application maintenance. Comments and macros are also permitted within embedded CICS commands. Integrated CICS translation is supported for use with CICS Transaction Server for z/OS V3R1 and above.

The CICS compiler option must be used when compiling source containing embedded CICS statements. When NOCICS is in effect, the compiler will treat the CICS-specific keywords, described below, as normal identifiers.

The CICS option enables the z/OS XL C/C++ compiler to pass suboptions to the integrated CICS translator. CICS suboptions are passed directly to the CICS

translator and have no other effect on compilation of C/C++ source. For more information on CICS suboptions, refer to *CICS Application Programming Guide*.

The CICS option will appear in the options listing with the suboptions. The `__CICS__` predefined macro is defined only when the CICS option is in effect and is not defined otherwise.

**Note:** The CICS option is not available via the **#pragma option** directive.

The `#pragma XOPTS` directive may also be used to pass options to the integrated CICS translator. Refer to *z/OS XL C/C++ Language Reference* for more information regarding this pragma directive.

A CICS embedded command will take the form of: EXEC CICS\_COMMAND\_KEYWORD xxxx; where:

- EXEC is a context-sensitive keyword. If the token following it is not recognized as a CICS keyword, then it is treated as part of the user name space.
- CICS\_COMMAND\_KEYWORD is either CICS, DLI, or CPSM. CICS, DLI, and CPSM are context-sensitive keywords and have special meaning only in the EXEC statement. These tokens may be used by the application program in user-defined names.
- xxxx is a command appropriate to the CICS\_COMMAND\_KEYWORD.

All text from EXEC up to the first semicolon will be processed by the CICS translator after C/C++ preprocessing. The command may span multiple lines.

**Note:** All keywords are case-insensitive, which means any combination of upper and lower-case characters may be used.

A CICS embedded command is expanded into a block statement and therefore can occur only at points in the code where a block statement is allowed.

A CICS embedded keyword will have the form of: CICS\_KEYWORD(CICS\_KEYWORD\_VALUE) where:

- CICS\_KEYWORD is either DFHVALUE, DFHRESP, or EYUVALUE. These are reserved keywords and cannot be used in any other context. These keywords are case-insensitive.
- CICS\_KEYWORD\_VALUE is a value that is appropriate to the CICS\_KEYWORD.

The compiler will send the entire string to the CICS translator after macro substitution and all comments are stripped out.

The following items are permitted within both CICS embedded commands and CICS embedded keywords:

- C/C++ comments
- C/C++ macros
- `#if` directives
- `#include` directives

Use of all other preprocessor directives, including all `#pragma` directives, will result in undefined behavior. The comments will be stripped, and macros and permitted directives will be expanded before the command or keyword is sent to the CICS translator.

When the CICS option is specified with the PPOONLY option, both CICS embedded commands and CICS embedded keywords will be preserved after all preprocessor macro substitution. #pragma XOPTS will be preserved as well.

**Notes:**

1. The compiler will not check compiler options for compatibility with CICS. This ensures that you can migrate to a later version of CICS without upgrading the compiler and still take advantage of previously incompatible features. You need to ensure that you have the required level of CICS Transaction Server on the target machines because the compiler does not check the TARGET option.
2. The compiler will not check for compatibility between pre-translators. The compiler will allow multiple pre-translators to operate on a single source file; for example, EXEC CICS statements may be intermixed with EXEC SQL statements. You must ensure that this is semantically correct.

## COMPACT | NOCOMPACT

Default: NOCOMPACT

| Option Scope |             |          |
|--------------|-------------|----------|
| C Compile    | C++ Compile | IPA Link |
| ✓            | ✓           | ✓        |

**Category:** Object Code Control



During optimizations performed as part of code generation, for both NOIPA and IPA, choices must be made between those optimizations which tend to result in faster but larger code and those which tend to result in smaller but slower code. The COMPACT option influences these choices. When the COMPACT option is used, the compiler favours those optimizations which tend to limit the growth of the code. Because of the interaction between various optimizations, including inlining, code compiled with the COMPACT option may not always generate smaller code and data. To determine the final status of inlining, generate and check the inline report. Not all subprograms are inlined when COMPACT is specified.

To evaluate the use of the COMPACT option for your application:

- Compare the size of the objects generated with COMPACT and NOCOMPACT
- Compare the size of the modules generated with COMPACT and NOCOMPACT
- Compare the execution time of a representative workload with COMPACT and NOCOMPACT

If the objects and modules are smaller with an acceptable change in execution time, then you can consider the benefit of using COMPACT.

As new optimizations are added to the compiler, the behavior of the COMPACT option may change. You should re-evaluate the use of this option for each new release of the compiler and when you change the application code.

You can specify this option for a specific subprogram using the #pragma **option\_override(subprogram\_name, "OPT(COMPACT)")** directive.

### Effect on IPA(OBJONLY) compilation

During a compilation with IPA Compile-time optimizations active, any subprogram-specific COMPACT option specified by **#pragma option\_override(subprogram\_name, "OPT(COMPACT)")** directives will be retained.

### Effect on IPA Compile step

The IPA Compile step generates information for the IPA Link step. This option also affects the regular object module if you request one by specifying the IPA(OBJECT) option.

### Effect on IPA Link step

If you specify the COMPACT option for the IPA Link step, it sets the Compilation Unit values of the COMPACT option that you specify. The IPA Link step Prolog listing section will display the value of this option.

If you do not specify COMPACT option in the IPA Link step, the setting from the IPA Compile step for each Compilation Unit will be used.

In either case, subprogram-specific COMPACT options will be retained.

The IPA Link step merges and optimizes your application code, and then divides it into sections for code generation. Each of these sections is a partition. The IPA Link step uses information from the IPA Compile step to determine if a subprogram can be placed in a particular partition. Only compatible subprograms are included in a given partition. Compatible subprograms have the same COMPACT setting.

The COMPACT setting for a partition is set to the specification of the first subprogram that is placed in the partition. Subprograms that follow are placed in partitions that have the same COMPACT setting. A NOCOMPACT subprogram is placed in a NOCOMPACT partition, and a COMPACT subprogram is placed in a COMPACT partition.

The option value that you specified for each IPA object file on the IPA Compile step appears in the IPA Link step Compiler Options Map listing section.

The Partition Map sections of the IPA Link step listing and the object module END information section display the value of the COMPACT option. The Partition Map also displays any subprogram-specific COMPACT values.

## COMPRESS | NOCOMPRESS

Default: NOCOMPRESS

| Option Scope |             |          |
|--------------|-------------|----------|
| C Compile    | C++ Compile | IPA Link |
| ✓            | ✓           | ✓        |

**Category:** Object Code Control



Use the COMPRESS option to suppress the generation of function names in the function control block thereby reducing the size of the load module for your application. Note that the function names are used by the dump service to provide you with meaningful diagnostic information when your program encounters a fatal program error. They are also used by tools such as Debug Tool and the Performance Analyzer. Without these function names, the reports generated by these services and tools may not be complete.

Note that if COMPRESS and TEST or DEBUG are in effect at the same time, the compiler issues a warning message and ignores the COMPRESS option.

### Effect on IPA Compile step

The IPA Compile step generates information for the IPA Link step. COMPRESS also affects the regular object module if you request one by specifying the IPA(OBJECT) option.

### Effect on IPA Link step

If you specify the COMPRESS option for the IPA Link step, it uses the value of the option that you specify. The IPA Link step Prolog listing section will display the value of the option that you specify.

If you do not specify COMPRESS option in the IPA Link step, the setting from the IPA Compile step will be used.

The IPA Link step merges and optimizes your application code, and then divides it into sections for code generation. Each of these sections is a partition. The IPA Link step uses information from the IPA Compile step to determine if a subprogram can be placed in a particular partition. Only compatible subprograms are included in a given partition. Compatible subprograms have the same COMPRESS setting.

The COMPRESS setting for a partition is set to the specification of the first subprogram that is placed in the partition. Subprograms that follow are placed in partitions that have the same COMPRESS setting. A NOCOMPRESS mode subprogram is placed in a NOCOMPRESS partition, and a COMPRESS mode subprogram is placed in a COMPRESS partition.

The option value that you specified for each IPA object file on the IPA Compile step appears in the IPA Link step Compiler Options Map listing section.

The Partition Map sections of the IPA Link step listing and the object module END information section display the value of the COMPRESS option.

## CONVLIT | NOCONVLIT

Default: NOCONVLIT(, NOWCHAR)

| Option Scope |             |          |
|--------------|-------------|----------|
| C Compile    | C++ Compile | IPA Link |
| ↙            | ↙           | ↙        |

**Category:** Preprocessor



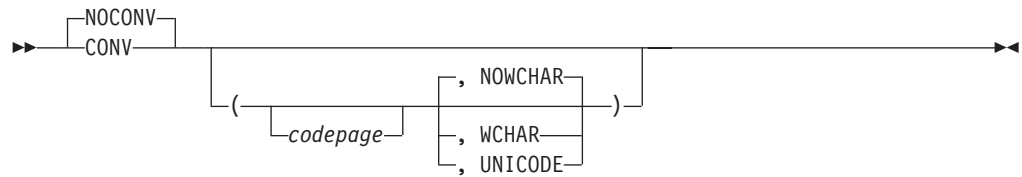

The CONVLIT option changes the assumed codepage for character and string literals within the compilation unit. You can use an optional suboption to specify the *codepage* that you want to use for string literals. If you specify NOCONV or CONV without a suboption, the default codepage, or the codepage specified by the LOCALE option is used.

You can also specify a suboption with the NOCONV option. The result of the following specifications is the same:

- NOCONV(IBM-1027) CONV
- CONV(IBM-1027)

The CONVLIT option affects all the source files that are processed within a compilation unit, including user header files and system header files. All string literals and character constants within a compilation unit are converted to the specified *codepage* unless you use **#pragma convlit(suspend)** and **#pragma convlit(resume)** to exclude sections of code from conversion. See *z/OS XL C/C++ Language Reference* for more information on **#pragma convlit**.

The CONVLIT option only affects string literals within the compilation unit. The following determines the codepage that the rest of the program uses:

- If you specified a LOCALE, the remainder of the program will be in the codepage that you specified with the LOCALE option.
- If you did not specify a LOCALE, the remainder of the program will be in the default codepage IBM-1047.

The CONVLIT option does not affect the following types of string literals:

- literals in the `#include` directive
- literals in the `#pragma` directive
- literals used to specify linkage, for example, `extern "C"`
- literals used for the `__func__` variables

The CONVLIT(, WCHAR) suboption instructs the compiler to change the codepage for wide character constants and string literals declared with the `L` or `L"` prefix. Although optional, the WCHAR suboption is positional, and must appear as the second suboption to the CONVLIT option. The default is NOWCHAR. Only wide character constants and string literals made up of single byte character set (SBCS) characters are converted. If there are any shift-out (SO) and shift-in (SI) characters in the literal, the compilation will end with an error message.

The z/OS XL C/C++ compiler interprets the CONVLIT(, UNICODE) suboption as a request to convert the wide string literals and wide character constants (`wchar_t`) to Unicode (UCS-2) regardless of the code page used for conversion of string literals and character constants (`char`). The conversion is supported for wide string literals and wide character constants that are coded using characters from the basic character set defined by the *Programming languages - C (ISO/IEC 9899:1999)*

standard. The behavior is undefined if wide string literals and wide character constants are coded using characters outside the basic character set.

The semantics of the **#pragma convlit(suspend/resume)** are not affected by this extension. No string literals or character constants (wide included), will be converted if **#pragma convlit(suspend)** is in effect.

The interaction between the **#pragma convlit(suspend/resume)** and **#pragma convert** is not affected by this extension. String literals and character constants will continue to be converted by the currently active **#pragma convert**. Wide string literals and wide character constants are not affected by **#pragma convert**, even when the new CONVLIT(, UNICODE) suboption is specified.

If you specify PPNLY with CONVLIT, the compiler ignores CONVLIT.

If you specify the CONVLIT option, the *codepage* appears after the locale name and locale code set in the Prolog section of the listing. The option appears in the END card at the end of the generated object module.

**Notes:**

1. Although you can continue to use the `__STRING_CODE_SET__` macro, you should use the CONV option instead. If you specify both the macro and the option, the compiler diagnoses it and uses the option regardless of the order in which you specify them
2. The **#pragma convert** directive provides similar functionality to the CONVLIT option. It has the advantage of allowing more than one character encoding to be used for string literals in a single compilation unit. For more information on the **#pragma convert** directive, see *z/OS XL C/C++ Language Reference*.

**Effect on IPA Compile step**

The CONVLIT option only controls processing for the IPA step for which you specify it.

During the IPA Compile step, the compiler uses the code page that is specified by the CONVLIT option to convert the character string literals.

**CSECT | NOCSECT**

Default: For NOGOFF, the default option is NOCSECT. For GOFF, the default option is CSECT().

| Option Scope |             |          |
|--------------|-------------|----------|
| C Compile    | C++ Compile | IPA Link |
| ✓            | ✓           | ✓        |

**Category:** Object Code Control



The CSECT option ensures that the code, static data, and test sections of your object module are named. Use this option, or the **#pragma CSECT** directive, if you

will be using SMP/E to service your product, and to aid in debugging your program. See *z/OS XL C/C++ Language Reference* for further information on the #pragma CSECT directive.

The NOCSECT option does not name the code, static, or test data sections of your object module.

The *qualifier* suboption of the CSECT option allows the compiler to generate long CSECT names.

For NOGOFF, if the LONGNAME compiler option is not in effect when you specify CSECT(*qualifier*), the compiler turns it on, and issues an informational message. For GOFF, both NOLONGNAME and LONGNAME options are supported.

The CSECT option names sections of your object module differently depending on whether you specified CSECT with or without a qualifier.

### The CSECT option with no qualifier

If you specify the CSECT option without the *qualifier* suboption, the CSECT option names the code, static data, and test sections of your object module as *csectname*, where *csectname* is one of the following:

- The member name of your primary source file, if it is a PDS member
- The low-level qualifier of your primary source file, if it is a sequential data set
- The source file name with path information and the right-most extension information removed, if it is a z/OS UNIX System Services file.
- For NOGOFF, if the NOLONGNAME option is in effect, then the *csectname* is truncated to 8 characters long starting from the left. For GOFF, the full *csectname* is always used.

code CSECT    Is named with *csectname* name in uppercase.

data CSECT    Is named with *csectname* in lower case.

test CSECT    When you use the TEST option together with the CSECT option, the debug information is placed in the test CSECT. The test CSECT is the static CSECT name with the prefix \$. If the static CSECT name is eight characters long, the right-most character is dropped and the compiler issues an informational message except in the case of GOFF. The test CSECT name is always truncated to eight characters.

For example, if you compile `/u/cricket/project/mem1.ext.c`:

- with the options NOGOFF and CSECT, the test CSECT will have the name `$mem1.ex`
- with the options GOFF and CSECT, the test CSECT will have the name `$mem1.ext`

### The CSECT option with the qualifier suboption

If you specify the CSECT option with the *qualifier* suboption, the CSECT option names the code, static data, and test sections of your object module as *qualifier#basename#suffix*, where:

*qualifier*        Is the suboption you specified as a *qualifier*

*basename*        Is one of the following:

- The member name of your primary source file, if it is a PDS member
- There is no basename, if your primary source file is a sequential data set or instream JCL

- The source file name with path information and the right-most extension information removed, if it is a z/OS UNIX file

*suffix* is one of the following:

|          |                  |
|----------|------------------|
| <b>C</b> | For code CSECT   |
| <b>S</b> | For static CSECT |
| <b>T</b> | For test CSECT   |

For example, if you compile `/u/cricket/project/mem1.ext.c` with the options `TEST` and `CSECT(example)`, the compiler constructs the CSECT names as follows:

```
example#mem1.ext#C
example#mem1.ext#S
example#mem1.ext#T
```

The *qualifier* suboption of the `CSECT` option allows the compiler to generate long CSECT names. If the compiler option `LONGNAME` is not in effect when you specify the `CSECT(qualifier)`, the compiler turns it on, and issues an informational message.

For example, if you compile `/u/cricket/project/reallylongfilename.ext.c` with the options `TEST` and `CSECT(example)`, the compiler constructs the CSECT names as follows:

```
example#reallylongfilename.ext#C
example#reallylongfilename.ext#S
example#reallylongfilename.ext#T
```

When you specify `CSECT(qualifier)`, the code, data, and test CSECTs are always generated. The test CSECT has content only if you also specify the `TEST` option.

If you use `CSECT("")` or `CSECT()`, the CSECT name has the form *basename#suffix*, where *basename* is:

- @Sequential@ for a sequential data set
- @InStream@ for instream JCL

#### Notes:

1. If the *qualifier* suboption is longer than 8 characters, you must use the binder.
2. The *qualifier* suboption takes advantage of the capabilities of the binder, and may not generate names acceptable to the z/OS Language Environment Prelinker.
3. The # that is appended as part of the #C, #S, or #T suffix is not locale-sensitive.
4. The string that is specified as the *qualifier* suboption has the following restrictions:
  - Leading and trailing blanks are removed
  - You can specify a string of any length. However if the complete CSECT name exceeds 1024 bytes, it is truncated starting from the left.
5. If the source file is either sequential or instream in your JCL, you must use the **#pragma csect** directive to name your CSECT. Otherwise, you may receive an error message at bind time.

#### Effect on IPA Link step

For the IPA Link step, this option has the following effects:

1. If you specify the `CSECT` option, the IPA Link step names all of the CSECTs that it generates.

The IPA Link step determines whether the IPA Link control file contains CSECT name prefix directives. If you did not specify the directives, or did not specify enough CSECT entries for the number of partitions, the IPA Link step automatically generates CSECT name prefixes for the remaining partitions, and issues an error diagnostic message each time.

The form of the CSECT name that IPA Link generates depends on whether the CSECT or CSECT(*qualifier*) format is used.

2. If you do not specify the CSECT option, but you have specified CSECT name prefix directives in the IPA Link control file, the IPA Link step names all CSECTs in a partition. If you did not specify enough CSECT entries for the number of partitions, the IPA Link step automatically generates a CSECT name prefix for each remaining partition, and issues a warning diagnostic message each time.
3. If you do not specify the CSECT option, and do not specify CSECT name prefix directives in the IPA Link control file, the IPA Link step does not name the CSECTs in a partition.

The IPA Link step ignores the information that is generated by **#pragma csect** on the IPA Compile step.

## CVFT | NOCVFT

Default: CVFT

| Option Scope |             |          |
|--------------|-------------|----------|
| C Compile    | C++ Compile | IPA Link |
|              | ✓           |          |

**Category:** Object Code Control



The NOCVFT option benefits your application's performance by shrinking the size of the writeable static area (WSA). It reduces the size of construction virtual function tables (CVFT), which in turn reduces the load module size. Use NOCVFT if none of the constructors in your application calls virtual functions from within the class hierarchy, either directly or indirectly.

The NOCVFT option relieves certain constructors from tracking which virtual function to call at different stages of the construction process. This tracking by the constructor would require that the constructor maintain its own CVFT. Only constructors that call virtual functions within a class hierarchy that uses virtual inheritance are affected.

**Example:** Consider the following example:

```
struct A {
    virtual int f() { return 0; }    // line a
};

struct B : virtual A {
    virtual int f() { return 1; }    // line b
    B() { cout << f() << endl; }
};

struct C : virtual B {
```

```

        virtual int f() { return 2; }    // line c
};
...

```

In the above example, if an instance of C is constructed, the ISO C++ standard requires that 1 (the number one) be printed. That is, the function B::f() at line b should be called during the construction of C. After C is constructed, a call to f() should invoke C::f() at line c. To support the ANSI behavior and call the right function, the z/OS XL C++ compiler needs to keep extra information during object construction. This extra information can require a lot of memory if an application uses a lot of virtual inheritance.

The NOCVFT option breaks the above ANSI C++ behavior. In that case, the virtual function called by the application is always the same one that would be called if the object is fully constructed. In the above example, this is C::f(), and 2 is printed during the construction of an instance of C (the function at line c). The CVFT option preserves the ANSI C++ behavior.

The CVFT option is shown on the listing prolog and the text deck end card.

### Effect on IPA Link step

The IPA Link step issues a diagnostic message if you specify the CVFT option for that step.

## DBRMLIB

Default: DBRMLIB(DD:DBRMLIB)

| Option Scope |             |          |
|--------------|-------------|----------|
| C Compile    | C++ Compile | IPA Link |
| ↙            | ↙           | ↙        |

**Category:** File Management

▶▶—DBRM—(—// *partitioned data set (member)*—)————▶▶

The DBRMLIB option specifies the data set for the database request module (DBRM), which is generated by the SQL option. The DBRM data set contains the embedded SQL statements and host variable information extracted from the source program, information that identifies the program, and ties the DBRM to the translated source statements. It becomes the input to the DB2 bind process.

**Note:** This option is only effective when the SQL option is specified.

The *partitioned data set* must be either a relative data set name, or an absolute data set name enclosed in single quotes. In either case, it must also be prepended by //.

When the option is specified in JCL, and a DBRMLIB DD statement is also specified, the option will take precedence over the DD statement.

The compiler does not verify the DCB attributes of the data set; you must ensure the data set is created with the correct attributes, as expected by DB2 UDB. Refer to *DB2 Application Programming and SQL Guide* for details.

# DEBUG | NODEBUG

Default: DEBUG(FORMAT(DWARF))

| Option Scope |             |          |
|--------------|-------------|----------|
| C Compile    | C++ Compile | IPA Link |
| ✓            | ✓           |          |

**Category:** Debugging

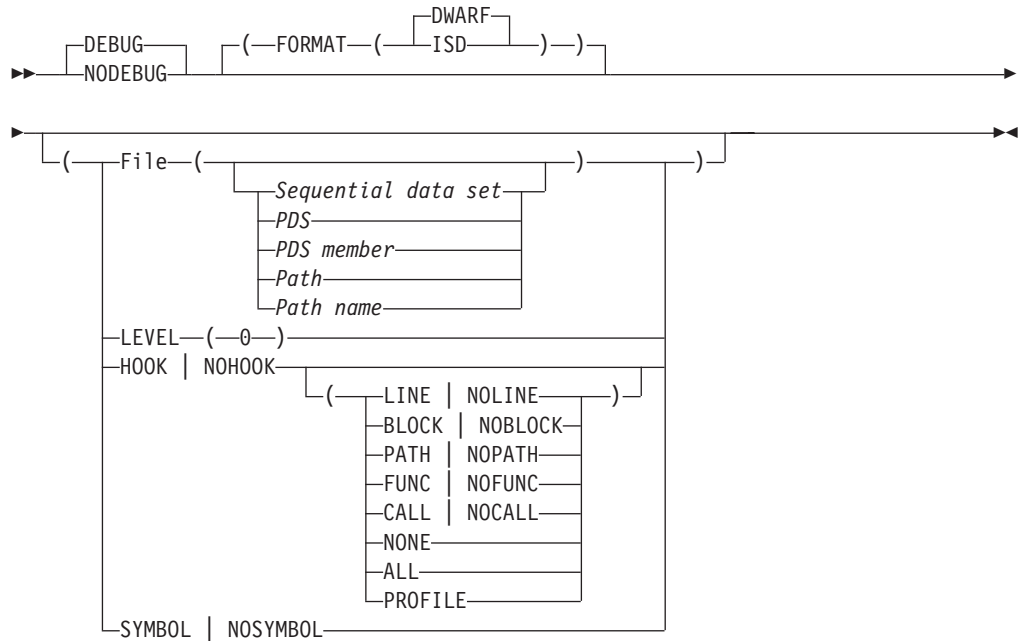

The DEBUG option instructs the compiler to generate debug information based on the DWARF Version 3 debugging information format, which has been developed by the UNIX International Programming Languages Special Interest Group (SIG), and is an industry standard format.

**Note:** Starting with z/OS V1R5, the Performance Analyzer only works with DEBUG(FORMAT(ISD)). This also means that it will not work on 64-bit executables.

The TEST and GONUMBER options remain unchanged but TEST will only work with ILP32. If you specify both TEST and DEBUG, the last valid specification is used. If you specify DEBUG and NODEBUG multiple times, the compiler uses the last specified option with the last specified suboption. For example, the following specifications have the same result:

```
cc -Wc,"NODEBUG(FORMAT(DWARF),HOOK(ALL))" -Wc,"DEBUG(NOSYMBOL)" hello.c
cc -WC,"DEBUG(FORMAT(DWARF),HOOK(ALL),NOSYMBOL)" hello.c
```

If you specify OPTIMIZE and DEBUG(FORMAT(DWARF)), no symbolic debug information is generated, but function entry, function exit, function call and function return hooks are generated. If you specify OPTIMIZE and DEBUG(FORMAT(ISD)), the behavior is the same as OPTIMIZE and TEST.

The following DEBUG suboptions are available:

## FORMAT

DEFAULT: FORMAT(DWARF)

Has the following suboptions: ISD and DWARF. ISD produces the same debug information as the TEST option. This suboption is available only with ILP32. If this format is used, the FILE suboption is ignored.

The DWARF suboption produces debug information in the DWARF Version 3 debugging information format, stored in the file specified by the FILE suboption. This is the only FORMAT supported with LP64. The compiler always generates a line number table in DWARF format when this suboption is specified; however, this DWARF line number table is incompatible with the Language Environment dump service routines (for example, ctrace()).

## FILE

Specifies the name of the output file for FORMAT(DWARF). It can be a *sequential data set*, a *PDS member*, or a *z/OS UNIX System Services file*. If you do not specify a file name, the compiler uses the SYSCDBG DD statement, or its alternative, if you allocated it. Otherwise, the compiler constructs a file name as follows:

- If you are compiling a data set, the compiler uses the source file name to form the name of the output data set. The high-level qualifier is replaced with the userid under which the compiler is running, and .DBG is appended as the low-level qualifier.
- If you are compiling a z/OS UNIX file, the compiler stores the debug information in a file that has the name of the source file with a .dbg extension.

For example, if TSY0U19 is compiling TSPERF.EON.SOURCE(EON) with the DEBUG option and does not specify a file name, the default output file name will be TSY0U19.EON.SOURCE.DBG(EON).

For a PDS or z/OS UNIX file system directory compile, the FILE option specifies the PDS or z/OS UNIX file system directory where the output files are generated.

The default for **c89** is FILE(/filename.dbg).

The compiler resolves the full path name for this file name, and places it in the generated object file. This information can be used by program analysis tools to locate the output file for FORMAT(DWARF). You can examine this generated file name in the compiler listing file (see "LIST | NOLIST" on page 146 for instructions on how to create a compiler listing file), as shown in the following example:

```
PPA4: Compile Unit Debug Block
000140 0000001A          =F'26'          DWARF File Name
000144 ****          C'/hfs/fullpath/filename.dbg'
```

If the compiler cannot resolve the full path name for the file name (for example, because the search permission was denied for a component of the file name), the compiler will issue a warning message, and the relative file name will be used instead.

## LEVEL



DEFAULT: LEVEL(0)

Controls the amount of debug information produced. LEVEL(0) is the only level currently supported.

## HOOK

DEFAULT: HOOK(ALL) for NOOPTIMIZE, HOOK(NONE,PROFILE) for OPTIMIZE

Controls the generation of LINE, BLOCK, PATH, CALL, and FUNC hook instructions. Hook instructions appear in the compiler Pseudo Assembly listing in the following form:

EX r0,HOOK.[type of hook]

The type of hook that each hook suboption controls is summarized in the list below:

- LINE
  - STMT - General statement
- BLOCK
  - BLOCK-ENTRY - Beginning of block
  - BLOCK-EXIT - End of block
  - MULTIEXIT - End of block and procedure
- PATH
  - LABEL - A label
  - DOBGN - Start of a loop
  - TRUEIF - True block for an if statement
  - FALSEIF - False block for an if statement
  - WHENBGN - Case block
  - OTHERW - Default case block
  - GOTO - Goto statement
  - POSTCOMPOUND - End of a PATH block
- CALL
  - CALLBGN - Start of a call sequence
  - CALLRET - End of a call sequence
- FUNC
  - PGM-ENTRY - Start of a function
  - PGM-EXIT - End of a function

There is also a set of shortcuts for specifying a group of hooks:

**NONE** It is the same as specifying NOLINE, NOBLOCK, NOPATH, NOCALL, and NOFUNC. It instructs the compiler to suppress all hook instructions.

**ALL** It is the same as specifying LINE, BLOCK, PATH, CALL, and FUNC. It instructs the compiler to generate all hook instructions. This is the ideal setting for debugging purposes.

### PROFILE

It is the same as specifying CALL and FUNC. It is the ideal setting for tracing the program with the Performance Analyzer.

## SYMBOL

DEFAULT: SYMBOL for NOOPT, NOSYMBOL for OPT

Generates symbol information that gives you access to variable and other symbol information.

If you specify the `INLINE` and `DEBUG` compiler options when `NOOPTIMIZE` is in effect, `INLINE` is ignored.

You can specify the `DEBUG` option and `TARGET` to a release prior to z/OS V1R5. However, if the debug format is `DWARF`, you must debug using `dbx` on a z/OS V1R5 (and above) system.

### Effect on IPA Compile step

For the IPA Compile step, you can specify all of the `DEBUG` suboptions that are appropriate for the language of the code that you are compiling. However, they affect processing only if you have requested code generation, and only the conventional object file is affected. If you specify the `NOOBJECT` suboption of the IPA compiler option on the IPA Compile step, the IPA Compile step ignores the `DEBUG` option, even though the listing still indicates that the `DEBUG` option has been specified.

### Effect on IPA Link step

The IPA Link step only supports the generation of function calls, entry, exit, and return hooks for profiling. If you specify any other `DEBUG` suboptions for the IPA Link step, it turns them off and issues a warning message. If `IPA(OBJONLY)` object files from the IPA Compile step are specified in the IPA Link step, only hooks for profiling are supported in the input object file.

**Note:** For an IPA-optimized application, the `DEBUG` option inserts additional instructions (the hooks mentioned above) into the application for profiling. This is different from the IPA Profile Directed Feedback option, which is used for tuning optimizations. During the compilation phase, in addition to the existing IPA compilation options, you must specify `DEBUG(HOOK(NONE,PROFILE), NOSYMBOL)`. During the IPA Link phase, in addition to the existing IPA Link options, you must specify `DEBUG(HOOK(NONE,PROFILE))`. Use of these options can affect the performance of your routine. You may need to remove the options and recompile your routine before delivering your application.

**Note:** See the “TEST | NOTEST” on page 206 for more information on debugging applications linked with IPA.

## DEFINE

Default: no default user definitions

For the z/OS UNIX System Services `c99`, `c89`, and `c++` utilities, the default for a regular compile is:

```
DEFINE(errno=*__errno())
```

```
DEFINE(_OPEN_DEFAULT=1)
```

For the z/OS UNIX System Services `cc` utility, the default for a regular compile is:

```
DEFINE(errno=(*__errno()+))
```

```
DEFINE(_OPEN_DEFAULT=0)
```

```
DEFINE(_NO_PROTO=1)
```

| Option Scope |             |          |
|--------------|-------------|----------|
| C Compile    | C++ Compile | IPA Link |
| ✓            | ✓           | ✓        |

**Category:** Preprocessor



The DEFINE option defines preprocessor macros that take effect before the compiler processes the file. You can use this option more than once.

**DEFINE(name)**

is equal to the preprocessor directive `#define name 1`.

**DEFINE(name=def)**

is equal to the preprocessor directive `#define name def`.

**DEFINE(name=)**

is equal to the preprocessor directive `#define name`.

If the suboptions that you specify contain special characters, see “Using special characters” on page 48 for information on how to escape special characters.

**Note:** There is no command-line equivalent for function-like macros that take parameters such as the following:

```
#define max(a,b) ((a)>(b)?(a):(b))
```

In the z/OS UNIX System Services environment, you can unset variables specified by `-D`, or automatically specified by **c89**, using `-U` when using the **c89**, **cc**, or **c++** commands.

**Note:** **c89** preprocesses `-D` and `-U` flags before passing them onto the compiler. **xlc** just passes `-D` and `-U` to the compiler, which interprets them as `DEFINE` and `UNDEFINE`. For more information, see Chapter 20, “c89 — Compiler invocation using host environment variables,” on page 489 or Chapter 21, “xlc — Compiler invocation using a customizable configuration file,” on page 527.

## DIGRAPH | NODIGRAPH

Default: DIGRAPH

| Option Scope |             |          |
|--------------|-------------|----------|
| C Compile    | C++ Compile | IPA Link |
| ✓            | ✓           | ✓        |

**Category:** Preprocessor

The DIGRAPH option allows you to use additional digraphs when building both C and C++ applications. In addition, it allows you to use additional keywords in C++ applications only. A *digraph* is a combination of keys that produces a character that is not available on some keyboards. Table 19 shows the digraphs that z/OS XL C/C++ supports:

Table 19. Digraphs

| Key Combination                 | Character Produced |
|---------------------------------|--------------------|
| <%                              | {                  |
| %>                              | }                  |
| <:                              | [                  |
| :>                              | ]                  |
| %:                              | #                  |
| %% <sup>1</sup>                 | #                  |
| %:%:                            | ##                 |
| %% <sup>1</sup> %% <sup>1</sup> | ##                 |

Table 20 shows additional keywords that z/OS XL C++ supports:

Table 20. Additional keywords

| Keyword | Characters produced |
|---------|---------------------|
| bitand  | &                   |
| and     | &&                  |
| bitor   |                     |
| or      |                     |
| xor     | ^                   |
| compl   | ~                   |
| and_eq  | &=                  |
| or_eq   | =                   |
| xor_eq  | ^=                  |
| not     | !                   |
| not_eq  | !=                  |

**Note:** Digraphs are not replaced in string literals, comments, or character literals. For example:

```
char * s = "<%%>"; // stays "<%%>"

switch (c) {
  case '<%': ... // stays '<%'
```

1. The digraphs %% and %%% are not digraphs in the C Standard. For compatibility with z/OS XL C++, however, they are supported by z/OS XL C. Use the %: and %:%: digraphs instead of %% and %%% whenever possible.

See *z/OS XL C/C++ Language Reference* for more information on digraphs.

### Effect on IPA Link step

The IPA Link step issues a diagnostic message if you specify the DIGRAPH option on that step.

## DLL | NODLL

Default: For a C compile and the IPA Link step, the default option is NODLL(NOCBA). For a C++ compile, the default option is DLL(NOCBA).

| Option Scope |             |          |
|--------------|-------------|----------|
| C Compile    | C++ Compile | IPA Link |
| ↙            | ↙           | ↙        |

**Category:** Object Code Control

For C and IPA Link:



For C++:



The DLL option instructs the compiler to produce DLL code. The DLL code can export or import functions and external variables.

The DLL option has two suboptions:

### **NOCALLBACKANY**

This is the default. If you specify NOCALLBACKANY, no changes will be made to the function pointer in your compile unit. The abbreviation for NOCALLBACKANY is NOCBA.

### **CALLBACKANY**

If you specify CALLBACKANY, all calls through function pointers will accommodate function pointers created by applications compiled without the DLL option. This accommodation accounts for the incompatibility of function pointers created with and without the DLL compiler option. The CALLBACKANY suboption is not supported when the XPLINK option is used. When function pointers having their origins (that is, where the address of a function is taken and assigned to a function pointer) in XPLINK code in the same or another DLL, or NOXPLINK NODLL code in another DLL, or non-XPLINK DLL code in another DLL, are passed to exported XPLINK functions, the compiler inserts code to check whether or not the function pointers received as actual arguments are valid (useable directly) XPLINK function pointers, and converts them if required. This provides results that are similar in many respects to the function pointer conversion provided when DLL(CALLBACKANY) is specified for

non-XPLINK code. Other function pointers that have their origins in non-XPLINK code, including function pointer parameters passed to non-exported functions or otherwise acquired, are not converted automatically by XPLINK compiled code. Use of such function pointers will cause the application to fail. The abbreviation for CALLBACKANY is CBA.

**Note:** You should write your code according to the rules listed in the chapter "Building Complex DLLs" in the *z/OS XL C/C++ Programming Guide*, and compile with the NOCALLBACKANY suboption. Use the suboption CALLBACKANY only when you have calls through function pointers and C code compiled without the DLL option. CALLBACKANY causes *all* calls through function pointers to incur overhead due to internally-generated calls to library routines that determine whether the function pointed to is in a DLL (in which case internal control structures need to be updated), or not. This overhead is unnecessary in an environment where all function pointers were created either in C++ code or in C code compiled with the DLL option.

For information on how to create or use DLLs, and on when to use the appropriate DLL options and suboptions, see *z/OS XL C/C++ Programming Guide*.

**Notes:**

1. If NODLL is specified for C++, it will be ignored.
2. You must use the LONGNAME and RENT options with the DLL option. If you use the DLL option without RENT and LONGNAME, the z/OS XL C compiler automatically turns them on. However, when the XPLINK option is used, though RENT and LONGNAME are the default options, both NOLONGNAME and NORENT are allowed.
3. In code compiled with the XPLINK compiler option, function pointers are compared using the address of the descriptor. No special considerations, such as dereferencing, are required to initialize the function pointer prior to comparison.
4. In code compiled with the NOXPLINK compiler option, you cannot cast a non-zero integer const type to a DLL function pointer type as shown in the following example:

```
void (*foo)();

void main() {
    /* ... */

    if (foo != (void (*)()) (50L) ) {
        /* do something other than calling foo */
    }
}
```

The above conditional expression will cause an abend at execution time because the function pointer (with value 50L) needs to be dereferenced to perform the comparison. The compiler will check for this type of casting problem if you use the CHECKOUT(CAST) option along with the DLL option. See "CHECKOUT | NOCHECKOUT" on page 78 for more information on obtaining diagnostic information for C applications.

**Effect on IPA Compile step**

The IPA Compile step generates information for the IPA Link step. The CALLBACKANY option also affects the regular object module if you request one by specifying the IPA(OBJECT) option.

## Effect on IPA Link step

The IPA Link step accepts the DLL compiler option, but ignores it.

The IPA Link step uses information from the IPA Compile step to classify an IPA object module as DLL or non-DLL as follows:

- C code that is compiled with the DLL option is classified as DLL.
- C++ code is classified as DLL
- C code that is compiled with the NODLL option is classified as non-DLL.

**Note:** If you are using IPA and specify the DLL compiler option, your code should export at least one function.

Each partition is initially empty and is set as DLL or non-DLL, when the first subprogram (function or method) is placed in the partition. The setting is based on the DLL or non-DLL classification of the IPA object module which contained the subprogram. Procedures from IPA object modules with incompatible DLL values will not be inlined. This results in reduced performance. For best performance, compile your application as all DLL code or all non-DLL code.

The IPA Link step allows you to input a mixture of IPA objects that are compiled with DLL(CBA) and DLL(NOCBA). The IPA Link step does not convert function pointers from the IPA Objects that are compiled with the option DLL(NOCBA).

You should only export subprograms (functions and C++ methods) or variables that you need for the interface to the final DLL. If you export subprograms or variables unnecessarily (for example, by using the EXPORTALL option), you severely limit IPA optimization. Global variables are not coalesced, and unreachable or 100% inlined code is not pruned.

## ENUMSIZE

Default: ENUM(SMALL)

| Option Scope |             |          |
|--------------|-------------|----------|
| C Compile    | C++ Compile | IPA Link |
| ✓            | ✓           | ✓        |

**Category:** Object Code Control



The ENUMSIZE option specifies the amount of storage occupied by enumerations. It enables you to select the type used to represent all enums defined in a compilation unit. ENUMSIZE has the following suboptions:

**SMALL**

Specifies that enumerations occupy a minimum amount of storage, which is either 1, 2, 4, or 8 bytes of storage, depending on the range of the enum constants.

## INT

Specifies that enumerations occupy 4 bytes of storage and are represented by int.

## INTLONG

Valid only when LP64 is specified and for C++ only. It specifies that enumerations occupy 8 bytes of storage and are represented by long if the range of the enum constants exceed the limit for int. Otherwise, the enumerations occupy 4 bytes of storage and are represented by int.

## 1

Specifies that enumerations occupy 1 byte of storage.

## 2

Specifies that enumerations occupy 2 bytes of storage

## 4

Specifies that enumerations occupy 4 bytes of storage.

## 8

Specifies that enumerations occupy 8 bytes of storage. This suboption is only valid with LP64.

The default is ENUM(SMALL). It allocates the amount of storage that is required by the smallest predefined type, which can represent that range of enum constants, to an enum variable. The other suboptions allocate a specific amount of storage to an enum variable.

If the specified storage size is smaller than that required by the range of enum constants, an error is issued by the compiler; for example:

```
#pragma enum(1)
enum e_tag {
    a = 0,
    b = SHRT_MAX /* error CCN3387 for C, CCN5525 for C++ */
} e_var;
#pragma enum(reset)
```

The following tables illustrate the preferred sign and type for each range of enum constants:

Table 21. ENUM constants for C and C++

| ENUM Constants | small          | 1             | 2     | 4   | 8 *  | int | intlong *<br>(C++ only) |
|----------------|----------------|---------------|-------|-----|------|-----|-------------------------|
| 0..127         | unsigned char  | signed char   | short | int | long | int | int                     |
| -128..127      | signed char    | signed char   | short | int | long | int | int                     |
| 0..255         | unsigned char  | unsigned char | short | int | long | int | int                     |
| 0..32767       | unsigned short | ERROR         | short | int | long | int | int                     |
| -32768..32767  | short          | ERROR         | short | int | long | int | int                     |



Table 21. ENUM constants for C and C++ (continued)

| ENUM Constants          | small          | 1     | 2              | 4            | 8 *           | int                                    | intlong *<br>(C++ only) |
|-------------------------|----------------|-------|----------------|--------------|---------------|--|-------------------------|
| 0..65535                | unsigned short | ERROR | unsigned short | int          | long          | int                                    | int                     |
| 0..2147483647           | unsigned int   | ERROR | ERROR          | int          | long          | int                                    | int                     |
| $-2^{31}..2^{31}-1$     | int            | ERROR | ERROR          | int          | long          | int                                    | int                     |
| 0..4294967295           | unsigned int   | ERROR | ERROR          | unsigned int | long          | unsigned int (C++ only)<br>ERROR for C | unsigned int            |
| $0..(2^{63}-1) *$       | unsigned long  | ERROR | ERROR          | ERROR        | long          | ERROR                                  | long                    |
| $-2^{63}..(2^{63}-1) *$ | long           | ERROR | ERROR          | ERROR        | long          | ERROR                                  | long                    |
| $0..2^{64} *$           | unsigned long  | ERROR | ERROR          | ERROR        | unsigned long | ERROR                                  | unsigned long           |

**Note:** The rows and columns marked with asterisks above (\*) are only valid when the LP64 option is in effect.

You can use **#pragma enum** to change the ENUM option value used for individual enum declaration in a source file. Refer to *z/OS XL C/C++ Language Reference* for more information regarding the **#pragma enum** directive.

## EVENTS | NOEVENTS

Default: NOEVENTS

| Option Scope |             |          |
|--------------|-------------|----------|
| C Compile    | C++ Compile | IPA Link |
| ✓            | ✓           | ✓        |

**Category:** Debug/Diagnostic

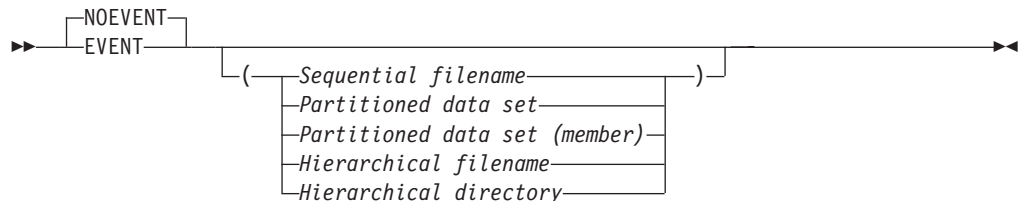

The EVENTS option creates an events file that contains error information and source file statistics. The compiler writes the events data to the DD:SYSEVENT ddname, if you allocated one before you called the compiler. Otherwise, it allocates a data set, and the name is the file name with SYSEVENT as the lowest-level qualifier.

If you specified a suboption, the compiler uses the *data set* that you specified, and ignores the DD:SYSEVENT.

If the source file is a z/OS UNIX System Services file, and you do not specify the events *file name* as a suboption, the compiler writes the events file in the current working directory. The events file name is the name of the source file with the extension `.err`.

The compiler ignores `#line` directives when the `EVENTS` option is active, and issues a warning message.

For a description of the layout of the event file, see Appendix E, “Layout of the Events file,” on page 617.

## EXECOPS | NOEXECOPS

Default: EXECOPS

| Option Scope |             |          |
|--------------|-------------|----------|
| C Compile    | C++ Compile | IPA Link |
| ✓            | ✓           | ✓        |

**Category:** Program Execution



The `EXECOPS` option allows you to control whether run-time options will be recognized at run time without changing your source code. It is equivalent to including a **`#pragma runopts (EXECOPS)`** directive in your source code.

If this option is specified on both the command line and in a **`#pragma runopts`** directive, the option on the command line takes precedence.

### Effect on IPA Compile step

If you specify `EXECOPS` for any compilation unit in the IPA Compile step, the compiler generates information for the IPA Link step. This option also affects the regular object module if you request one by specifying the `IPA(OBJECT)` option.

### Effect on IPA Link step

If you specify the `EXECOPS` option for the IPA Compile step, you do not need to specify it again on the IPA Link step. The IPA Link step uses the information generated for the compilation unit that contains the `main()` function. If it cannot find a compilation unit that contains `main()`, it uses information generated for the first compilation unit that it finds.

If you specify this option on both the IPA Compile and the IPA Link steps, the setting on the IPA Link step overrides the setting on the IPA Compile step. This situation occurs whether you use `EXECOPS` and `NOEXECOPS` as compiler options, or specify them by using the **`#pragma runopts`** directive on the IPA Compile step.

## EXH | NOEXH

Default: EXH

| Option Scope |             |          |
|--------------|-------------|----------|
| C Compile    | C++ Compile | IPA Link |
|              | ✓           |          |

**Category:** Object Code Control



The EXH option controls the generation of C++ exception handling code.

The NOEXH option suppresses the generation of the exception handling code, which results in code that runs faster, but will not be ANSI-compliant if the program uses exception handling.

If you compile a source file with NOEXH, active objects on the stack are not destroyed if the stack collapses in an abnormal fashion. For example, if a C++ object is thrown, or a Language Environment exception or signal is raised, objects on the stack will not have their destructors run.

If NOEXH has been specified and the source file has try/catch blocks or throws objects, the program may not execute as expected.

### Effect on IPA Link step

The IPA Link step issues a diagnostic message if you specify the EXH option for that step.

## EXPMAC | NOEXPMAC

Default: NOEXPMAC

In the z/OS UNIX System Services environment, this option is turned on by specifying -V when using the **c99**, **c89**, **cc** or **c++** commands.

| Option Scope |             |          |
|--------------|-------------|----------|
| C Compile    | C++ Compile | IPA Link |
| ✓            | ✓           | ✓        |

**Category:** Listing



The EXPMAC option instructs the compiler to show all expanded macros in the source listing. If you want to use the EXPMAC option, you must also specify the SOURCE compiler option to generate a source listing. If you specify the EXPMAC option but omit the SOURCE option, the compiler issues a warning message, and does not produce a source listing.

## EXPORTALL | NOEXPORTALL

Default: NOEXPORTALL

| Option Scope |             |          |
|--------------|-------------|----------|
| C Compile    | C++ Compile | IPA Link |
| ✓            | ✓           | ✓        |

**Category:** Object Code Control



The EXPORTALL option instructs the compiler to export all external functions and variables in the compilation unit so that a DLL application can use them. Use this option if you are creating a DLL and want to export all external functions and variables defined in the DLL. You may not export the `main()` function.

### Notes:

1. If you only want to export some of the external functions and variables in the DLL, use **#pragma export**, or the `_Export` keyword for C++. For more information on **#pragma export**, see *z/OS XL C/C++ Language Reference*.
2. For C, you must use the LONGNAME and RENT options with the EXPORTALL option. If you use the EXPORTALL option without RENT and LONGNAME, the z/OS XL C compiler turns them on.
3. Unused extern inline functions will not be exported when the EXPORTALL option is specified.

### Effect on IPA Compile step

The IPA Compile step generates information for the IPA Link step. The EXPORTALL option also affects the regular object module if you request one by specifying the IPA(OBJECT) option.

### Effect on IPA Link step

The IPA Link step accepts the EXPORTALL option, but ignores it.

If you use the EXPORTALL option during the IPA Compile step, you severely limit IPA optimization. Refer to “DLL | NODLL” on page 97 for more information about the effects of this option on IPA processing.

## FASTTEMPINC | NOFASTTEMPINC

Default: NOFASTT

| Option Scope |             |          |
|--------------|-------------|----------|
| C Compile    | C++ Compile | IPA Link |
|              | ✓           |          |

**Category:** File Management



The FASTTEMPINC option may improve template instantiation compilation time when large numbers of recursive templates are used in an application.

The FASTTEMPINC option defers generating object code until the final version of all template definitions have been determined. Then, a single compilation pass is made to generate the final object code. This means that time is not wasted on generating object code that will be discarded and generated again.

When NOFASTT is used, the compiler generates object code each time a tempinc source file is compiled. If recursive template definitions in a subsequent tempinc source file cause additional template definitions to be added to a previously processed file, an additional recompilation pass is required.

Use FASTT if you have large numbers of recursive templates. If your application has very few recursive template definitions, the time saved by not doing code generation may be less than the time spent in source analysis on the additional template compilation pass. In this case, it may be better to use NOFASTT.

### Effect on IPA Link step

The IPA Link step issues a diagnostic message if you specify the FASTT option for that step.

## FLAG | NOFLAG

Default: FLAG(I)

For the z/OS UNIX System Services utilities, the default for a regular compile is FLAG(W).

To specify FLAG(I) using the c89 utility, you must specify -V.

| Option Scope |             |          |
|--------------|-------------|----------|
| C Compile    | C++ Compile | IPA Link |
| ✓            | ✓           | ✓        |

**Category:** Debug/Diagnostic



The FLAG option specifies the minimum severity level for which you want notification. You specify the minimum severity level by using the compiler option FLAG(*severity*), where *severity* is one of the following:

- I** An informational message.
- W** A warning message that calls attention to a possible error, although the statement to which it refers is syntactically valid.
- E** An error message that shows that the compiler has detected an error and cannot produce an object deck.
- S** A severe error message that describes an error that forces the compilation to terminate.
- U** An unrecoverable error message that describes an error that forces the compilation to terminate.

If you specified the options SOURCE or LIST, the messages generated by the compiler appear immediately following the incorrect source line, and in the message summary at the end of the compiler listing.

The NOFLAG option is the same as the FLAG(U) option.

### Effect on IPA Link step

The FLAG option has the same effect on the IPA Link step that it does on a regular compilation.

## FLOAT

Default: FLOAT(HEX, FOLD, NOMAF, NORRM, NOAFP or AFP). For ARCH(2), the default suboption is NOAFP. For ARCH(3) or higher, the default suboption is AFP(NOVOLATILE). For LP64, the default suboption is IEEE.

| Option Scope |             |          |
|--------------|-------------|----------|
| C Compile    | C++ Compile | IPA Link |
| ↙            | ↙           | ↙        |

**Category:** Object Code Control

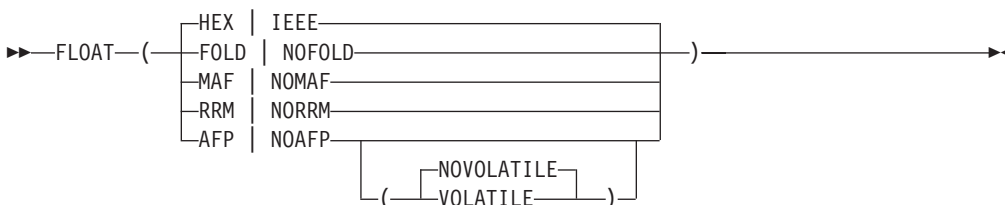

The FLOAT option selects the format of floating-point numbers; the format can be either base 2 IEEE-754 binary format, or base 16 z/Architecture hexadecimal format. In the description below, the IEEE-754 binary format is referred to as the binary floating-point format, and the z/Architecture hexadecimal format as the hexadecimal floating-point format. FLOAT has the following suboptions:

### HEX | IEEE

DEFAULT (ILP32): HEX

DEFAULT (LP64): IEEE

Specifies the format of floating-point numbers and instructions:

- IEEE instructs the compiler to generate binary floating-point numbers and instructions. The unabbreviated form of this suboption is IEEE754.
- HEX instructs the compiler to generate hexadecimal formatted floating-point numbers and instructions. The unabbreviated form of this suboption is HEXADECIMAL.

### FOLD | NOFOLD

DEFAULT: FOLD

Specifies that constant floating-point expressions in function scope are to be evaluated at compile time rather than at run time. This is known as *folding*.

In binary floating-point mode, the folding logic uses the rounding mode set by the ROUND option.

In hexadecimal floating-point mode, the rounding is always towards zero. If you specify NOFOLD in hexadecimal mode, the compiler issues a warning and uses FOLD.

#### **MAF | NOMAF**

DEFAULT:

- NOMAF
- If NOSTRICT and FLOAT(IEEE) are specified, MAF is the default.

Uses floating-point Multiply and Add, and Multiply and Subtract instructions where possible, instead of the separate Multiply Float, Add Float, or Multiply Float, Subtract Float instruction pairs.

**Note:** The suboption MAF does not have any effect on extended floating-point operations.

MAF is not available for hexadecimal floating-point mode.

#### **RRM | NORRM**

DEFAULT: NORRM

Run-time Rounding Mode (RRM) tells the compiler that the run-time rounding mode may not be the default, round-to-nearest, and prevents compiler optimizations that rely on round-to-nearest rounding mode. Use this option if your program changes the rounding mode by any means. Otherwise, the program may compute incorrect results.

RRM is not available for hexadecimal floating-point mode.

#### **AFP(VOLATILE | NOVOLATILE) | NOAFP**

DEFAULT: AFP(NOVOLATILE)

- If the level of the ARCH option is lower than 3, the default is NOAFP.
- If the level of the ARCH option is 3 or higher, the default is AFP(NOVOLATILE).
- When there is no sub-option specified for AFP, the default is NOVOLATILE.

AFP instructs the compiler to generate code which makes use of the full complement of 16 floating point registers. These include the four original floating-point registers, numbered 0, 2, 4, and 6, and the Additional Floating Point (AFP) registers, numbered 1, 3, 5, and 7 through 15.

AFP is not available before ARCH(3). If the code generated utilizing AFP registers must run on a pre-ARCH(3) machine, emulation is provided by the operating system. Code with AFP registers will not run on a system that is older than G5 and OS/390 V2R6.

**Note:** This emulation has a significant performance cost to the execution of the application on the non-AFP processors. This is why the default is NOAFP when ARCH(2) or lower is specified.

If VOLATILE is specified then AFP registers are considered volatile, which means they (FPR8 - FPR15) are not expected to be preserved by the

called program. This prevents AFP registers from becoming corrupted if the application runs in an environment where the AFP registers are not preserved across task switching. Using the AFP(VOLATILE) sub-option to save the contents of AFP registers across calls could have an impact on performance. You should evaluate the performance costs prior to using this suboption.

NOAFP limits the compiler to generating code using only the original four floating-point registers, 0, 2, 4, and 6, which are available on all IBM System z machine models.

## Using IEEE floating-point

You should use IEEE floating-point in the following situations:

- You deal with data that are already in IEEE floating-point format
- You need the increased exponent range (see *z/OS XL C/C++ Language Reference* for information on exponent ranges with IEEE-754 floating-point)
- You want the changes in programming paradigm provided by infinities and NaN (not a number)

For more information about the IEEE format, refer to the *IEEE 754-1985 IEEE Standard for Binary Floating-Point Arithmetic*.

When you use IEEE floating-point, make sure that you are in the same rounding mode at compile time (specified by the ROUND(*mode*) option), as at run time. Entire compilation units will be compiled with the same rounding mode throughout the compilation. If you switch run-time rounding modes inside a function, your results may vary depending upon the optimization level used and other characteristics of your code; switch rounding mode inside functions with caution.

If you have existing data in hexadecimal floating-point (the original base 16 z/Architecture hexadecimal floating-point format), and have no need to communicate these data to platforms that do not support this format, there is no reason for you to change to IEEE floating-point format.

Applications that mix the two formats are not supported.

The binary floating-point instruction set is physically available only on processors that are part of the ARCH(3) group or higher. You can request FLOAT(IEEE) code generation for an application that will run on an ARCH(2) or earlier processor, if that processor runs on the OS/390 Version 2 Release 6 or higher operating system. This operating system level is able to intercept the use of an "illegal" binary floating-point instruction, and emulate the execution of that instruction such that the application logic is unaware of the emulation. This emulation comes at a significant cost to application performance, and should only be used under special circumstances. For example, to run exactly the same executable object module on backup processors within your organization, or because you make incidental use of binary floating-point numbers.

## Effect on IPA Compile step

The IPA Compile step generates information for the IPA Link step. This option also affects the regular object module if you request one by specifying the IPA(OBJECT) option.

**Note:** The option FLOAT(AFP(VOLATILE)) is not supported by IPA. If the option FLOAT(AFP(VOLATILE)) is passed to the IPA Compile or Link phase, then the IPA phase will emit a severe diagnostic message.



## Effect on IPA Link step

The IPA Link step merges and optimizes the application code, and then divides it into sections for code generation. Each of these sections is a partition. The IPA Link step uses information from the IPA Compile step to determine if a subprogram can be placed in a particular partition. Only compatible subprograms are included in a given partition. Compatible subprograms have the same floating-point mode, and the same values for the FLOAT suboptions, and the ROUND and STRICT options:

- Floating-point mode (binary or hexadecimal)

The floating-point mode for a partition is set to the floating-point mode (binary or hexadecimal) of the first subprogram that is placed in the partition. Subprograms that follow are placed in partitions that have the same floating-point mode; a binary floating-point mode subprogram is placed in a binary floating-point mode partition, and a hexadecimal mode subprogram is placed in a hexadecimal mode partition.

If you specify FLOAT(HEX) or FLOAT(IEEE) during the IPA Link step, the option is accepted, but ignored. This is because it is not possible to change the floating-point mode after source analysis has been performed.

The Prolog and Partition Map sections of the IPA Link step listing display the setting of the floating-point mode.

- AFP | NOAFP

The value of AFP for a partition is set to the AFP value of the first subprogram that is placed in the partition. Subprograms that have the same AFP value are then placed in that partition.

You can override the setting of AFP by specifying the suboption on the IPA Link step. If you do so, all partitions will contain that value, and the Prolog section of the IPA Link step listing will display the value.

The Partition Map section of the IPA Link step listing and the END information in the IPA object file display the current value of the AFP suboption.

- FOLD | NOFOLD

Hexadecimal floating-point mode partitions are always set to FOLD.

For binary floating-point partitions, the value of FOLD for a partition is set to the FOLD value of the first subprogram that is placed in the partition. Subprograms that have the same FOLD value are then placed in that partition. During IPA inlining, subprograms with different FOLD settings may be combined in the same partition. When this occurs, the resulting partition is always set to NOFOLD.

You can override the setting of FOLD | NOFOLD by specifying the suboption on the IPA Link step. If you do so, all binary floating-point mode partitions will contain that value, and the Prolog section of the IPA Link step listing will display the value.

For binary floating-point mode partitions, the Partition Map section of the IPA Link step listing displays the current value of the FOLD suboption.

- MAF | NOMAF

For IPA object files generated with the FLOAT(IEEE) option, the value of MAF for a partition is set to the MAF value of the first subprogram that is placed in the partition. Subprograms that have the same MAF for this suboption are then placed in that partition.

For IPA object files generated with the FLOAT(IEEE) option, you can override the setting of MAF | NOMAF by specifying the suboption on the IPA Link step. If you do so, all binary floating-point mode partitions will contain that value, and the Prolog section of the IPA Link step listing will display the value.

For binary floating-point mode partitions, the Partition Map section of the IPA Link step listing displays the current value of the MAF suboption.

Hexadecimal mode partitions are always set to NOMAF. You cannot override this setting.

- RRM | NORRM

For IPA object files generated with the FLOAT(IEEE) option, the value of RRM for a partition is set to the RRM value of the first subprogram that is placed in the partition. During IPA inlining, subprograms with different RRM settings may be combined in the same partition. When this occurs, the resulting partition is always set to RRM.

For IPA object files generated with the FLOAT(IEEE) option, you can override the setting of RRM | NORRM by specifying the suboption on the IPA Link step. If you do so, all binary floating-point mode partitions will contain that value, and the Prolog section of the IPA Link step listing will display the value.

For binary floating-point mode partitions, the Partition Map section of the IPA Link step listing displays the current value of the RRM suboption.

Hexadecimal mode partitions are always set to NORRM. You cannot override this setting.

- ROUND option

For IPA object files generated with the FLOAT(IEEE) option, the value of the ROUND option for a partition is set to the value of the first subprogram that is placed in the partition.

You can override the setting of ROUND by specifying the option on the IPA Link step. If you do so, all binary floating-point mode partitions will contain that value, and the Prolog section of the IPA Link step listing will display the value.

For binary floating-point mode partitions, the Partition Map section of the IPA Link step listing displays the current value of the ROUND suboption.

Hexadecimal mode partitions are always set to round towards zero. You cannot override this setting.

- STRICT option

The value of the STRICT option for a partition is set to the value of the first subprogram that is placed in the partition. During IPA inlining, subprograms with different STRICT settings may be combined in the same partition. When this occurs, the resulting partition is always set to STRICT.

You can override the setting of STRICT by specifying the option on the IPA Link step. If you do so, the Prolog section of the IPA Link step listing will display the value.

If there are no Compilation Units with subprogram-specific STRICT options, all partitions will have the same STRICT value.

If there are any Compilation Units with subprogram-specific STRICT options, separate partitions will continue to be generated for those subprograms with a STRICT option, which differs from the IPA Link option.

The Partition Map sections of the IPA Link step listing and the object module display the value of the STRICT option.

**Note:** The inlining of subprograms (C functions, C++ functions and methods) is inhibited if the FLOAT suboptions (including the floating-point mode), and the ROUND and STRICT options are not all compatible between compilation units. Calls between incompatible compilation units result in reduced performance. For best performance, compile your applications with consistent options.

## GOFF | NOGOFF

Default: NOGOFF

**Note:** When XPLINK or LP64 is used, the default is GOFF.

| Option Scope |             |          |
|--------------|-------------|----------|
| C Compile    | C++ Compile | IPA Link |
| ✓            | ✓           | ✓        |

**Category:** Object Code Control



The GOFF option instructs the compiler to produce an object file in the Generalized Object File Format (GOFF). The GOFF format supersedes the S/370™ Object Module and Extended Object Module formats. It removes various limitations of the previous format (for example, 16 MB section size) and provides a number of useful extensions, including native z/OS support for long names and attributes. GOFF incorporates some aspects of industry standards such as XCOFF and ELF.

When you specify the GOFF option, the compiler uses LONGNAME and CSECT() by default. You can override these default values by explicitly specifying the NOLONGNAME or the NOCSECT option.

When you specify the GOFF option, you must use the binder to bind the output object. You cannot use the prelinker to process GOFF objects.

**Note:** When using GOFF and source files with duplicate file names, the linker may emit an error and discard one of the code sections. In this case, turn off the CSECT option by specifying NOCSECT.

### Effect on IPA Compile step

The GOFF option affects the regular object module if you request one by specifying the IPA(OBJECT) option. This option affects the IPA-optimized object module generated when you specify the IPA(OBJECT) option.

The IPA information in an IPA object file is always generated using the XOBJ format.

### Effect on IPA Link step

The IPA Link Step merges and optimizes the application code, and then divides it into sections for code generation. Each of these sections is a partition. The GOFF option affects the object format of the code and data generated for each partition.

Information from non-IPA input files is processed and transformed based on the original format. GOFF format information remains in GOFF format; all other formats (OBJ, XOBJ, load module) are passed in XOBJ format.

## GONUMBER | NOGONUMBER

Default: NOGONUMBER

In the z/OS UNIX System Services environment, this option is turned on by specifying **-g** when using the **c89**, **cc** or **c++** commands.

| Option Scope |             |          |
|--------------|-------------|----------|
| C Compile    | C++ Compile | IPA Link |
| ✓            | ✓           | ✓        |

**Category:** Debug/Diagnostic



The GONUMBER option generates line number tables that correspond to the input source file. These tables are for use by Debug Tool and for error trace back information when an exception occurs.

The compiler turns on GONUMBER when the TEST compiler option is in effect.

The GONUMBER option is active by default when you use the DEBUG option. The DEBUG option will activate the GONUMBER option unless NOGONUMBER has been explicitly specified. In the z/OS UNIX environment, the GONUMBER option is enforced when you use the **-g** flag option using the **c89** or **xlc** commands. In another words, the **-g** flag option will always activate the GONUMBER option, regardless of other option specifications.

**Note:** When you specify the GONUMBER option, a comment that indicates its use is generated in your object module to aid you in diagnosing your program.

You can specify this option using the **#pragma options** directive for C.

### Effect on IPA Compile step

If you specify the GONUMBER option on the IPA Compile step, the compiler saves information about the source file line numbers in the IPA object file.

If you do not specify the GONUMBER option on the IPA Compile step, the object file produced contains the line number information for source files that contain function begin, function end, function call, and function return statements. This is the minimum line number information that the IPA Compile step produces. You can then use the TEST option on the IPA Link step to generate corresponding test hooks.

### Effect on IPA Link step

If you specify the GONUMBER option for the IPA Link step, the IPA Link step creates GONUMBER tables during code generation. The level of detail in these tables depends on the options that you used for the IPA Compile step. The GONUMBER table will only contain information for those compilation units that are compiled with the GONUMBER option.

If you do not specify the GONUMBER option on the IPA Link step, then the GONUMBER table will not be generated regardless of how the IPA object files are compiled.

Refer to “Interactions between compiler options and IPA suboptions” on page 47 and “LIST | NOLIST” on page 146 for more information.

## HALT(num)

Default: HALT(16)

| Option Scope |             |          |
|--------------|-------------|----------|
| C Compile    | C++ Compile | IPA Link |
| ✓            | ✓           | ✓        |

**Category:** Input Source File Processing Control

▶▶—HALT—(num)—▶▶

The HALT option stops compilation, depending on the return code from the compiler. This option applies to the compilation of all members of a PDS or a z/OS UNIX System Services file system directory. If the return code from compiling a particular member is greater than or equal to the value *num* specified in the HALT option, no more members are compiled.

Valid codes for *num* correspond to return codes from the compiler. See *z/OS XL C/C++ Messages* for a list of return codes.

### Effect on IPA Link step

The HALT option affects the IPA Link step in a way similar to the way it affects the IPA Compile step, but the message severity levels may be different. Also, the severity levels for the IPA Link step and a C++ compilation include the "unrecoverable" level.

## HALTONMSG | NOHALTONMSG

Default: NOHALTON

| Option Scope |             |          |
|--------------|-------------|----------|
| C Compile    | C++ Compile | IPA Link |
| ✓            | ✓           | ✓        |

**Category:** Input Source File Processing Control

▶▶—NOHALTON—  
HALTON—(—n—)—▶▶

The HALTONMSG option instructs the C/C++ front end to stop after the compilation phase when it encounters the specified *msg\_number*. When the compilation stops as a result of the HALTONMSG option, the compiler return code is nonzero.

**Note:** The HALTONMSG option for C allows you to specify more than one message number by separating the message numbers with commas. The HALTONMSG option for C++ can only accept one message number.

## HGPR | NOHGPR

Default: NOHGPR

| Option Scope |             |          |
|--------------|-------------|----------|
| C Compile    | C++ Compile | IPA Link |
| ✓            | ✓           | ✓        |

**Category:** Object Code Control

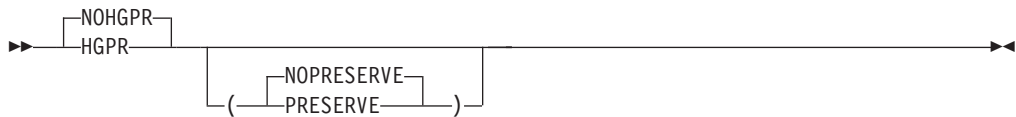

The HGPR compiler option enables the compiler to exploit 64-bit General Purpose Registers (GPRs) for 32-bit applications targeting z/Architecture hardware. HGPR means "High GPR", which refers to the use of the additional "high" bits available in 64-bit instructions. In particular, if the application has the use of long long types, it should benefit from the native 64-bit instructions.

### Notes:

1. The HGPR compiler option permits the compiler to exploit 64-bit GPRs in the generated code. The compiler will take the advantage of this permission when the code generation condition is appropriate.
2. The HGPR compiler option requires ARCH(5) (and above).

The PRESERVE suboption instructs the compiler to preserve the high halves of the 64-bit GPRs that a function is using, by saving them in the prolog for the function and restoring them in the epilog. Because of performance considerations, the default suboption for HGPR is NOPRESERVE. The PRESERVE suboption is only necessary if the caller is not known to be z/OS XL C/C++ compiler-generated code.

### Effect on IPA Compile step

The IPA Compile step generates information for the IPA Link step. If IPA(OBJECT) or IPA(OBJONLY) is specified, then the resulting object module will be compiled with the specified HGPR setting.

### Effect on IPA Link step

The IPA Link step will accept the HGPR option, but ignores it. The IPA Link step merges and optimizes the application code, and then divides it into sections for code generation. Each of these sections is a partition. The HGPR setting for a partition is determined by the first function that is imported into the partition. All other functions that are imported into the given partition must have the same HGPR option setting.

## HOT | NOHOT

Default: NOHOT

In the z/OS UNIX System Services environment, if the xlc utility flag option -O, -O2, or -O3 is specified, the default is NOHOT. If -O4 or -O5 is specified, the default is HOT.

| Option Scope |             |          |
|--------------|-------------|----------|
| C Compile    | C++ Compile | IPA Link |
| ✓            | ✓           |          |

**Category:** Object Code Control



The HOT compiler option enables the compiler to request high-order transformations on loops during optimization, which gives you the ability to generate more highly optimized code. For the z/OS V1R8 release of the compiler, the option will only affect IPA Compile phase processing.

**Note:** You must specify either the LONGNAME compiler option or the **#pragma longname** preprocessor directive whenever the HOT option is specified. Otherwise, the compiler issues an unrecoverable error diagnostic message.

The HOT option is independent of the UNROLL command line option or pragma. The HOT option setting will be listed in the compiler listing, the IPA Link phase listing, and the end card of the output object file.

The HOT option can be specified with the debugging options TEST and DEBUG. The debugging information added to the output object code when HOT is used with TEST or DEBUG will be the same level of debugging information that is added when TEST or DEBUG is used with OPT(2).

If HOT is specified, the optimization level is forced to a level of at least 2. If a lower level is requested, it is increased to 2. If a higher level is requested, the requested value is used.

If **-g** is specified, then **-Wc,NOHOT** is forced.

## IGNERRNO | NOIGNERRNO

Default: For NOOPT and OPT(2), the default option is NOIGNERRNO. For OPT(3), the default option is IGNERRNO.

| Option Scope |             |          |
|--------------|-------------|----------|
| C Compile    | C++ Compile | IPA Link |
| ✓            | ✓           | ✓        |

**Category:** Object Code Control

For NOOPT and OPT(2):



For OPT(3):



The `IGNERRNO` option informs the compiler that your application is not using `errno`. Specifying this option allows the compiler to explore additional optimization opportunities for library functions in `LIBANSI`. The input to the library functions is assumed to be valid. Invalid input can lead to undefined behavior.

ANSI library functions use `errno` to return the error condition. If your program does not use `errno`, the compiler has more freedom to explore optimization opportunities for some of these functions (for example, `sqrt()`). You can control this optimization by using the `IGNERRNO` option.

The `IGNERRNO` option is turned on by `OPTIMIZE(3)`. Use `NOIGNERRNO` to turn it off if necessary. `NOIGNERRNO` must appear after `OPTIMIZE(3)`, otherwise it is ignored.

You can specify this option using the `#pragma options` directive for C.

### Effect on IPA Compile step

The IPA Compile step generates information for the IPA Link step. The `IGNERRNO` option also affects the regular object module if you request one by specifying the `IPA(OBJECT)` option.

### Effect on IPA Link step

The IPA Link step accepts the `IGNERRNO` option, but ignores it. The IPA Link step merges and optimizes the application's code, and then divides it into sections for code generation. Each of these sections is a partition. The IPA Link step uses information from the IPA Compile step to determine if a subprogram can be placed in a particular partition. Only compatible subprograms are included in a given partition. Compatible subprograms have the same `IGNERRNO` option setting. For the purpose of this compatibility checking, objects produced by compilers prior to OS/390 Version 2 Release 9, where `IGNERRNO` is not supported, are considered `NOIGNERRNO`.

The value of the `IGNERRNO` option for a partition is set to the value of the first subprogram that is placed in the partition. The Partition Map sections of the IPA Link step listing and the object module display the value of the `IGNERRNO` option.

## INFO | NOINFO

Default: For C++, the default option is `INFO(LAN)`. For C, the default option is `NOINFO`.

For the z/OS UNIX System Services `c99`, `c89`, and `cc` utilities, the default for a regular compile is `NOINFO(ALL)`. For the z/OS UNIX System Services `c++` utility, the default for a regular compile is `INFO(LAN)`.

In the z/OS UNIX System Services environment, this option is turned on by specifying `-V`.

| Option Scope |             |          |
|--------------|-------------|----------|
| C Compile    | C++ Compile | IPA Link |
| ✓            | ✓           |          |



**Category:** Debug/Diagnostic

For C:

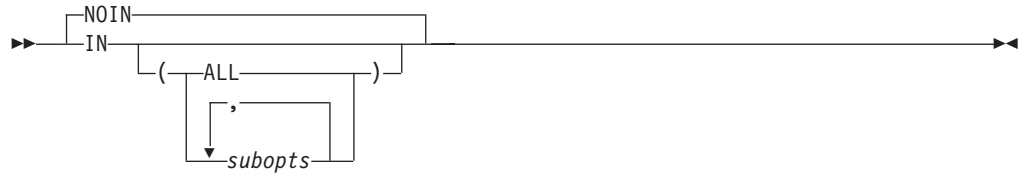

For C++:

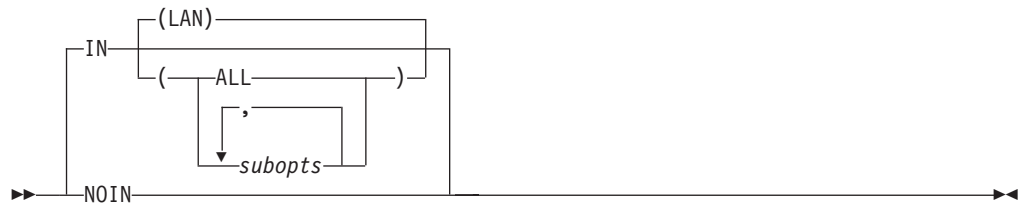

**Note:** The INFO option may not produce the same diagnostic messages as the previous releases.

The INFO option instructs the compiler to generate warning messages. Use *subopts* if you want to specify the type of warning messages.

If you specify INFO with no suboptions, it is the same as specifying INFO(ALL). The following is a list of the *subopts*:

- CLS** Emits class informational warning messages (C++ only).
- CMP** Emits conditional expression check messages.
- CND** Emits messages on redundancies or problems in conditional expressions.
- CNV** Emits messages about conversions.
- CNS** Emits redundant operation on constants messages.
- CPY** Emits warnings about copy constructors (C++ only).
- EFF** Emits information about statements with no effect.
- ENU** Emits information about ENUM checks.
- EXT** Emits warnings about unused variables that have external declarations (C only).
- GNR** Emits information about the generation of temporary variables (C++ only).
- GEN** Emits message if compiler generates temporaries.
- LAN** Emits language level checks.
- PAR** Emits warning messages on unused parameters.
- POR** Emits warnings about non-portable constructs.
- PPC** Emits messages on possible problems with using the preprocessor.
- PPT** Emits trace of preprocessor actions.

- REA** Emits warnings about unreachable statements.
- RET** Emits warnings about return statement consistency.
- TRD** Emits warnings about possible truncation of data.
- UND** Emits warnings about undefined classes (C++ only).
- USE** Emits information about usage of variables.
- VFT** Indicates where vftable is generated (C++ only).
- ALL** Emits all of the above

**no suboptions**

Same result as INFO(ALL).

In the z/OS UNIX System Services environment, if you use the **c++** command, the suboption is ALL. If you use the **c99**, **c89** or **cc** commands, the suboptions are ALL, NOEXT, NOPPC, and NOPPT.

**Effect on IPA Link step**

The IPA Link step issues a diagnostic message if you specify the INFO option.

## INITAUTO | NOINITAUTO

Default: NOINITAUTO

| Option Scope |             |          |
|--------------|-------------|----------|
| C Compile    | C++ Compile | IPA Link |
| ↙            | ↙           | ↙        |

**Category:** Object Code Control

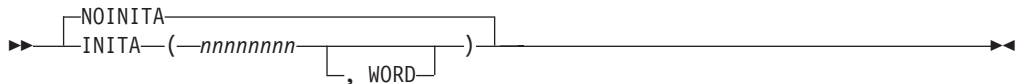

The INITAUTO option tells the compiler to generate code to initialize automatic variables. Automatic variables require storage only while the block in which they are declared is active. See *z/OS XL C/C++ Language Reference* for more information on automatic variables.

Automatic variables without initializers are not implicitly initialized. The INITAUTO option instructs the compiler to generate code to initialize these variables with a user-defined value.

In the above syntax, the hexadecimal value you specify for *nnnnnnnn* represents the initial value for automatic storage in bytes. It can be two to eight hexadecimal digits in length. There is no default for this value.

The suboption WORD is optional, and can be abbreviated to W. If you specify WORD, *nnnnnnnn* is a word initializer; otherwise it is a byte initializer. Only one initializer can be in effect for the compilation. If you specify INITAUTO more than once, the compiler uses the last setting.

If you specify a byte initializer, and specify more than 2 digits for *nnnnnnnn*, the compiler uses the last 2 digits. If you specify a word initializer, the compiler uses the last 2 digits to initialize a byte, and all digits to initialize a word.

**Note:** The word initializer is useful in checking uninitialized pointers.

Since extra code is generated, this option can reduce the run-time performance of the program.

### **Effect on IPA Compile step**

The IPA Compile step generates information for the IPA Link step. The INITAUTO option also affects the regular object module if you request one by specifying the IPA(OBJECT) option.

### **Effect on IPA Link step**

You can specify the INITAUTO option for an IPA Link step, and it will override the setting in the compile step.

If you do not specify the INITAUTO option in the IPA Link step, the setting in the IPA Compile step will be used. The IPA Link step merges and optimizes the application's code, and then divides it into sections for code generation. Each of these sections is a partition. The IPA Link step uses information from the IPA Compile step to determine if a subprogram can be placed in a particular partition. Only compatible subprograms are included in a given partition. Compatible subprograms have the same INITAUTO setting.

The IPA Link step sets the INITAUTO setting for a partition to the specification of the first subprogram that is placed in the partition. It places subprograms that follow in partitions that have the same INITAUTO setting.

You can override the setting of INITAUTO by specifying the option on the IPA Link step. If you do so, all partitions will use that value, and the Prolog section of the IPA Link step listing will display the value.

The Partition Map sections of the IPA Link step listing and the object module display the value of the INITAUTO option.

## **INLINE | NOINLINE**

Default:

For a C/C++ compile:

- If NOOPT is in effect:

```
NOINLINE
(AUTO,NOREPORT,
100,1000)
```

- If OPT is in effect:

```
INLINE
(AUTO,NOREPORT,
100,1000)
```

NOOPT is the default for C/C++ compile.

For IPA Link:

- If NOOPT is in effect:

```
NOINLINE
(AUTO,NOREPORT,
1000,8000)
```

- If OPT is in effect:

```
INLINE
(AUTO,NOREPORT,
1000,8000)
```

OPT is the default for IPA Link.

For the c99, c89, cc, and c++ z/OS UNIX System Services utilities, the default is NOINLINE(AUTO,NOREPORT,,).

For the z/OS UNIX utilities, when NOOPT is specified, the default is NOINLINE(AUTO,NOREPORT,100,1000). For the z/OS UNIX utilities, when OPT is specified, the default is INLINE(AUTO,NOREPORT,100,1000).

In the z/OS UNIX environment, specifying -V, when using the **c89** or **cc** commands, will turn on the REPORT suboption of INLINE. The INLINE option itself is not touched (or changed) by -V.

| Option Scope |             |          |
|--------------|-------------|----------|
| C Compile    | C++ Compile | IPA Link |
| ✓            | ✓           | ✓        |

#### Category: Object Code Control and Listing

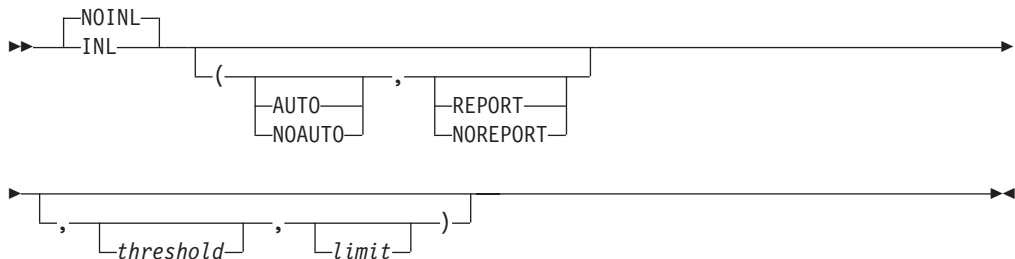

The INLINE option instructs the compiler to place the code for selected subprograms at the point of call; this is called *inlining*. It eliminates the linkage overhead and exposes the entire inlined subprogram for optimization by the global optimizer. It has the following effects:

- The compiler invokes the compilation unit inliner to perform inlining of functions within the current compilation unit.
- If the compiler inlines all invocations of a static subprogram, it removes the non-inlined instance of the subprogram.
- If the compiler inlines all invocations of an externally visible subprogram, it does not remove the non-inlined instance of the subprogram. This allows callers who are outside of the current compilation unit to invoke the non-inlined instance.
- If you specify INLINE(,REPORT,,) or INLRPT, the compiler generates the Inline Report listing section.

For more information on optimization and the INLINE option, refer to the section about optimizing code in the *z/OS XL C/C++ Programming Guide*.

You can specify `INLINE` without suboptions if you want to use the defaults. You must include a comma between each suboption even if you want to use the default for one of the suboptions. You must specify the suboptions in the following order:

#### AUTO | NOAUTO

The inliner runs in automatic mode and inlines subprograms within the *threshold* and *limit*.

For C only, if you specify `NOAUTO` the inliner only inlines those subprograms specified with the **#pragma inline** directive. The **#pragma inline** and **#pragma noinline** directives allow you to determine which subprograms are to be inlined and which are not when the `INLINE` option is specified. These `#pragma` directives have no effect if you specify `NOINLINE`. See *z/OS XL C/C++ Language Reference* for more information on `#pragma` directives.

The default is `AUTO`.

#### REPORT | NOREPORT

An inline report becomes part of the listing file. The inline report consists of the following:

- An inline summary
- A detailed call structure

You can obtain the same report if you use the `INLRPT` and `OPT` options. For more information on the inline report, see “Inline Report” on page 270, “Inline Report” on page 256, and “Inline Report for IPA inliner” on page 279.

The default is `NOREPORT`.

#### *threshold*

The maximum relative size of a subprogram to inline. For C/C++ compiles, the default for *threshold* is 100 Abstract Code Units (ACUs). For the IPA Link step, the default for *threshold* is 1000 ACUs. ACUs are proportional in size to the executable code in the subprogram; the z/OS XL C compiler translates your z/OS XL C code into ACUs. The maximum *threshold* is `INT_MAX`, as defined in the header file `limits.h`. Specifying a threshold of 0 is the same as specifying `NOAUTO`.

#### *limit*

The maximum relative size a subprogram can grow before auto-inlining stops. For C/C++ compiles, the default for *limit* is 1000 ACUs for a subprogram. For the IPA Link step, the default for *limit* is 8000 ACUs for that subprogram. The maximum for *limit* is `INT_MAX`, as defined in the header file `limits.h`. Specifying a limit of 0 is equivalent to specifying `NOAUTO`.

You can specify the `INLINE | NOINLINE` option on the invocation line and for C in the **#pragma options** preprocessor directive. When you use both methods at the same time, the compiler merges the options. If an option on the invocation line conflicts with an option in the **#pragma options** directive, the one on the invocation line takes precedence.

For example, because you typically do not want to inline your subprograms when you are developing a program, you can specify the `NOINLINE` option on a **#pragma options** preprocessor directive. When you want to inline your subprograms, you can override the `NOINLINE` option by specifying `INLINE` on the invocation line rather than by editing your source program. The following example illustrates these rules.

**Source file:**

```
#pragma options (NOINLINE(NOAUTO,NOREPORT,,2000))
```

**Invocation line:**

```
INLINE (AUTO,,)
```

**Result:**

```
INLINE (AUTO,NOREPORT,100,2000)
```

**Notes:**

1. When you specify the `INLINE` compiler option, a comment, with the values of the suboptions, is generated in your object module to aid you in diagnosing your program.
2. If the compiler option `OPT` is specified, `INLINE` becomes the default.
3. Specify the `INLRPT`, `LIST`, or `SOURCE` compiler options to redirect the output from the `INLINE(,REPORT,,)` option.
4. If you specify `INLINE` and `TEST`:
  - at `OPT(0)`, `INLINE` is ignored
  - at `OPT`, inlining is done
5. If you specify `NOINLINE`, no subprograms will be inlined even if you have **#pragma inline** directives in your code.
6. If you specify `INLINE`, subprograms may not be inlined or inline other subprograms when `COMPACT` is specified (either directly or via **#pragma option\_override**). Generate and check the inline report to determine the final status of inlining. The inlining may not occur when `OPT(0)` is specified via the **#pragma option\_override**.

You can specify this option using the **#pragma options** directive for C.

**Effect on IPA Compile step**

The `INLINE` option generates inlined code for the regular compiler object; therefore, it affects the IPA Compile step only if you specify `IPA(OBJECT)`. If you specify `IPA(NOOBJECT)`, `INLINE` has no effect, and there is no reason to use it.

**Effect on IPA Link step**

If you specify the `INLINE` option on the IPA Link step, it has the following effects:

- The IPA Link step invokes the IPA inliner, which inlines subprograms (functions and C++ methods) in the entire program.
- The IPA Link step uses **#pragma inlinenoinline** directive information and `inline` subprogram specifier information from the IPA Compile step for source program inlining control. Specifying the `INLINE` option on the IPA Compile step has no effect on IPA Link step inlining processing.

You can use the IPA Link control file `inline` and `noinline` directives to explicitly control the inlining of subprograms on the IPA Link step. These directives override IPA Compile step **#pragma inline | noinline** directives and `inline` subprogram specifiers.

- If the IPA Link step inlines all invocations of a subprogram, it removes the non-inlined instance of the subprogram, unless the subprogram entry point was exported using a **#pragma export** directive or the `EXPORTALL` compiler option, or was retained using the IPA Link control file `retain` directive. IPA Link processes static subprograms and externally visible subprograms in the same manner.

The IPA inliner has the inlining capabilities of the compilation unit inliner. In addition, the IPA inliner detects complex recursion, and may inline it. If you specify the

INLRPT option, the IPA Link listing contains the IPA Inline Report section. This section is similar to the report that the compilation unit inliner generates. If you specify NOINLINE(,REPORT,,) or NOINLINE INLRPT, IPA generates an IPA Inline Report section that specifies that nothing was inlined.

## INLRPT | NOINLRPT

Default: NOINLRPT

In the z/OS UNIX System Services environment, the output of this option goes to stdout. This option is turned on by specifying -V.

| Option Scope |             |          |
|--------------|-------------|----------|
| C Compile    | C++ Compile | IPA Link |
| ✓            | ✓           | ✓        |

**Category:** Listing

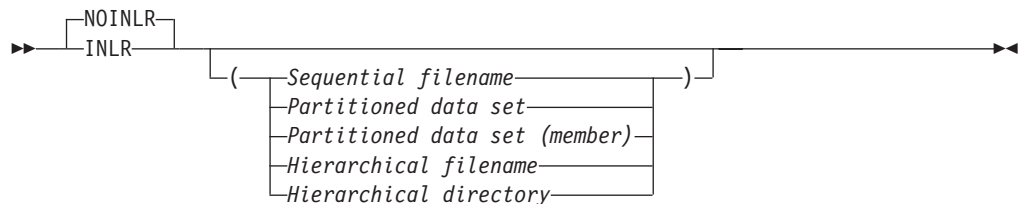

If you use the OPTIMIZE option, you can also use INLRPT to specify that the compiler generate a report as part of the compiler listing. This report provides the status of subprograms that were inlined, specifies whether they were inlined or not and displays the reasons for the action of the compiler.

You can specify *filename* for the inline report output file. If you do not specify *filename*, the compiler uses the SYSCPRT ddname if you allocated one. If you did not allocate SYSCPRT, the compiler uses the source file name to generate a file name.

The NOINLR option can optionally take a *filename* suboption. This *filename* then becomes the default. If you subsequently use the INLR option without *filename*, the compiler uses the *filename* that you specified in the earlier specification or NOINLR. For example,

```
CXX HELLO (NOINLR(/hello.lis) INLR OPT
```

is the same as specifying:

```
CXX HELLO (INLR(/hello.lis) OPT
```

**Note:** If you specify *filename* with any of the SOURCE, LIST, or INLRPT options, all the listing sections are combined into the last *filename* specified.

If you specify this multiple times, the compiler uses the last specified option with the last specified suboption. The following two specifications have the same result:

1. CXX HELLO (NOINLR(/hello.lis) INLR(/n1.lis) NOINLR(/test.lis) INLR
2. CXX HELLO (INLR(/test.lis)

## Effect on IPA Link step

If you specify the INLRPT option on the IPA Link step, the IPA Link step listing contains an IPA Inline Report section. Refer to “INLINE | NOINLINE” on page 119 for more information about generating an IPA Inline Report section.

## IPA | NOIPA

Default: NOIPA

The default for the c99, c89, cc, c++ z/OS UNIX System Services utilities is: NOIPA(NOCONTROL(ipa.ct1),DUP,NOER,NOMAP,NOUPCASE,NONCAL)IPA(LINK,LEVEL(1)).

| Option Scope |             |          |
|--------------|-------------|----------|
| C Compile    | C++ Compile | IPA Link |
| ↙            | ↙           | ↙        |

**Category:** Object Code Control, IPA Link Control, IPA Object Control, File Management, Listing and Debug/Diagnostic

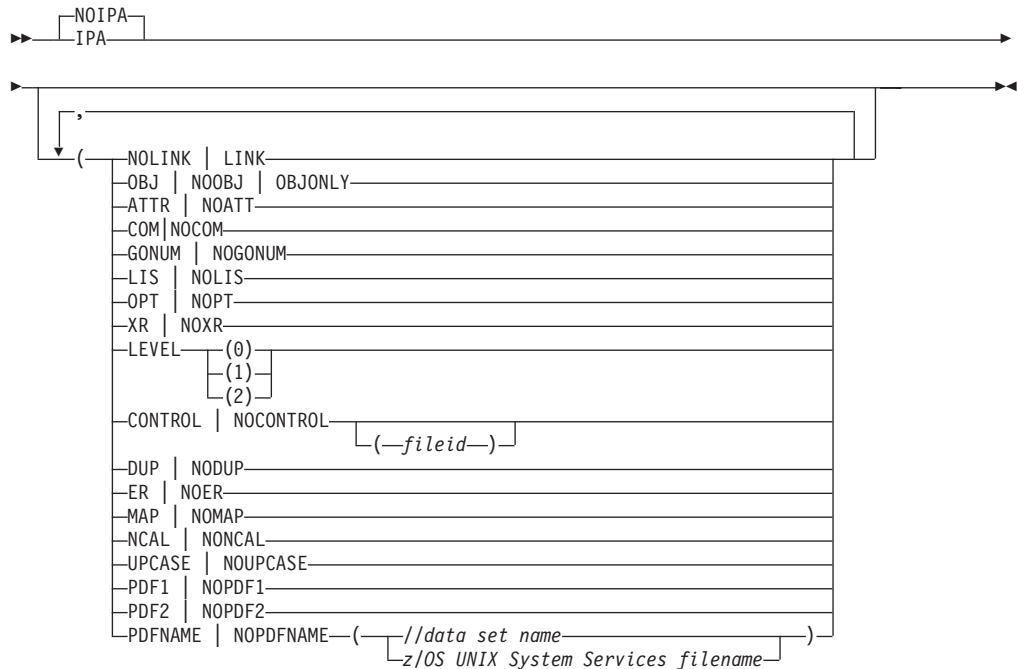

The IPA option instructs the compiler to perform Interprocedural Analysis across compilation units.

The NOIPA option instructs the compiler to perform a regular compilation.

## IPA Compile step suboptions

IPA(NOLINK) invokes the IPA Compile step. NOLINK is the default suboption of the IPA option. Only the following IPA suboptions affect the IPA Compile step. You can specify other IPA suboptions, but they do not affect the IPA Compile step.

**ATTRIBUTE | NOATTRIBUTE** Indicates whether the compiler saves information about symbols in the IPA object file. The IPA Link



step uses this information if you specify the ATTR or XREF option on that step.

The difference between specifying IPA(ATTR) and specifying ATTR or XREF is that IPA(ATTR) does not generate a Cross Reference or Static Map listing sections after IPA Compile step source analysis is complete. It also does not generate a Storage Offset, Static Map, or External Symbol Cross Reference listing section during IPA Compile step code generation.

The default is IPA(NOATTRIBUTE). The abbreviations are IPA(ATTRINOATTR). If you specify the ATTR or XREF option, it overrides the IPA(NOATTRIBUTE) option.

#### COMPRESS | NOCOMPRESS

Indicates that the IPA object information is compressed to significantly reduce the size of the IPA object file.

The default is IPA(COMPRESS). The abbreviations are IPA(COMINOCOM).

#### GONUMBER | NOGONUMBER

Indicates whether the compiler saves information about source file line numbers in the IPA object file. The difference between specifying IPA(GONUMBER) and GONUMBER is that IPA(GONUMBER) does not cause GONUMBER tables to be built during IPA Compile step code generation. If the compiler does not build GONUMBER tables, the size of the object module is smaller.

Refer to “GONUMBER | NOGONUMBER” on page 111 for information about the effect of this suboption on the IPA Link step. Refer also to “Interactions between compiler options and IPA suboptions” on page 47.

The default is IPA(NOGONUMBER). The abbreviations are IPA(GONUMINOGONUM). If you specify the GONUMBER or LIST option, it overrides the IPA(NOGONUMBER) option.

#### LIST | NOLIST

Indicates whether the compiler saves information about source line numbers in the IPA object file. The difference between specifying IPA(LIST) and LIST is that IPA(LIST) does not cause the IPA Compile step to generate a Pseudo Assembly listing.

Refer to “LIST | NOLIST” on page 146 for information about the effect of this suboption on the IPA Link step. Refer also to “Interactions between compiler options and IPA suboptions” on page 47.

The default is IPA(NOLIST). The abbreviations are IPA(LISINOLIS). If you specify the GONUMBER or LIST option, it overrides the IPA(NOLIST) option.

#### OBJECT | NOOBJECT | OBJONLY

Controls the content of the object file.

- OBJECT

The options IPA(NOLINK,OBJECT) result in an IPA Compile step.

The compiler performs IPA Compile-time optimizations and generates IPA object information for the resulting program information. In addition, the compiler generates non-IPA object code and data that is based on the original program information. Refer to *z/OS XL C/C++ Programming Guide* for a list of optimizations.

The object file may be used by an IPA Link step, a prelink/link, or a bind.

- NOOBJECT

The options IPA(NOLINK,NOOBJECT) result in an IPA Compile step.

The compiler performs IPA Compile-time optimizations and generates IPA object information for the resulting program information. No non-IPA object code or data is generated.

The object file may be used by an IPA Link step only.

- OBJONLY

The IPA(OBJONLY) compilation is an intermediate level of optimization. This results in a modified regular compile, not an IPA Compile step. Unlike the IPA Compile step, no IPA information is written to the object file.

During compilation, this step performs the same IPA-specific compile-time optimizations as the IPA Compile step, performs the requested non-IPA optimizations, and then generates optimized object code and data.

The object file may be used by an IPA Link step, a prelink/link, or a bind. If it is used as input to an IPA Link step, no IPA Link-time optimizations can be performed for this compilation unit because no IPA information is available.

For all options in this mode, the *Effect on IPA Compile Step* and *Effect on IPA Link Step* considerations do not apply.

The default is IPA(OBJECT). The abbreviations are IPA(OBJINOOBJIOBJO).

#### OPTIMIZE | NOOPTIMIZE

The default is IPA(OPTIMIZE) If you specify IPA(NOOPTIMIZE), the compiler issues an

informational message and turns on IPA(OPTIMIZE). The abbreviations are IPA(OPTINOOPT) .

IPA(OPTIMIZE) generates information (in the IPA object file) that will be needed by the OPT compiler option during IPA Link processing.

If you specify the IPA(OBJECT), the IPA(OPTIMIZE), and the NOOPTIMIZE option during the IPA Compile step, the compiler creates a non-optimized object module for debugging. If you specify the OPT(1) or OPT(2) option on a subsequent IPA Link step, you can create an optimized object module without first rerunning the IPA Compile step.

#### XREF | NOXREF

Indicates whether the compiler saves information about symbols in the IPA object file that will be used in the IPA Link step if you specify ATTR or XREF on that step.

The difference between specifying IPA(XREF) and specifying ATTR or XREF is that IPA(XREF) does not cause the compiler to generate a Cross Reference or Static Map listing sections after IPA Compile step source analysis is complete. It also does not cause the compiler to generate a Storage Offset, Static Map, or External Symbol Cross Reference listing section during IPA Compile step code generation.

Refer to “XREF | NOXREF” on page 220 for information about the effects of this suboption on the IPA Link step.

The default is IPA(NOXREF). The abbreviations are IPA(XRINOXR). If you specify the ATTR or XREF option, it overrides the IPA(NOXREF) option.

### IPA Link step suboptions

IPA(LINK) invokes the IPA Link step. Only the following IPA suboptions affect the IPA Link step. If you specify other IPA suboptions, they do not affect the IPA Link step.

#### CONTROL[(fileid)] | NOCONTROL[(fileid)]

Specifies whether a file that contains IPA directives is available for processing. You can specify an optional *fileid*. If you specify both IPA(NOCONTROL(*fileid*)) and IPA(CONTROL), in that order, the IPA Link step resolves the option to IPA(CONTROL(*fileid*)).

The default *fileid* is DD:IPACNTL if you specify the IPA(CONTROL) option. The default is IPA(NOCONTROL).

#### DUP | NODUP

Indicates whether the IPA Link step writes a message and a list of duplicate symbols to the console.

The default is IPA(DUP).

## ER | NOER

Indicates whether the IPA Link step writes a message and a list of unresolved symbols to the console.

The default is IPA(NOER).

## LEVEL(0|1|2)

Indicates the level of IPA optimization that the IPA Link step should perform after it links the object files into the call graph.

If you specify LEVEL(0), IPA performs subprogram pruning and program partitioning only.

If you specify LEVEL(1), IPA performs all of the optimizations that it does at LEVEL(0), as well as subprogram inlining and global variable coalescing. IPA performs more precise alias analysis for pointer dereferences and subprogram calls.

Under IPA Level 1, many optimizations such as constant propagation and pointer analysis are performed at the intraprocedural (subprogram) level. If you specify LEVEL(2), IPA performs specific optimizations across the entire program, which can lead to significant improvement in the generated code.

The compiler option OPTIMIZE that you specify on the IPA Link step controls subsequent optimization for each partition during code generation. Regardless of the optimization level you specified during the IPA Compile step, you can request IPA optimization, regular code generation optimization, both, or neither, on the IPA Link step.

The default is IPA(LEVEL(1)).

## MAP | NOMAP

Specifies that the IPA Link step will produce a listing. The listing contains a Prolog and the following sections:

- Object File Map
- Compiler Options Map
- Global Symbols Map (which may or may not appear, depending on how much global coalescence was done during optimization)
- Partition Map for each partition
- Source File Map

The default is IPA(NOMAP).

See “Using the IPA Link step listing” on page 271 for more information.

## NCAL | NONCAL

Indicates whether the IPA Link step performs an automatic library search to resolve references in files that the IPA Compile step produces. Also indicates whether the IPA Link step performs library searches to locate an object file or files that satisfy unresolved symbol references within the current set of object information.

This suboption controls both explicit searches triggered by the LIBRARY IPA Link control statement, and the implicit SYSLIB search that occurs at the end of IPA Link input processing.

To help you remember the difference between NCAL and NONCAL, you may wish to think of NCAL as "nocall" and NONCAL as "no nocall", (or "call").

The default is IPA(NONCAL).

## UPCASE | NOUPCASE

Determines whether the IPA Link step makes an additional automatic library call pass for SYSLIB if unresolved references remain at the end of standard IPA Link processing. Symbol matching is not case sensitive in this pass.

This suboption provides support for linking assembler language object routines, without forcing you to make source changes. The preferred approach is to add **#pragma map** definitions for these symbols, so that the correct symbols are found during normal IPA Link automatic library call processing.

The default is IPA(NOUPCASE). The abbreviations are IPA(UPCINOUPC).

## IPA(PDF) suboptions

The following section describes the IPA(PDF) suboptions.

### PDF1 | NOPDF1, PDF2 | NOPDF2, PDFNAME | NOPDFNAME

The default is IPA(NOPDF1, NOPDF2, NOPDFNAME).

**Note:** IPA(PDF) applies to both the IPA Link and IPA Compile steps.

PDF (Profile-Directed Feedback) is a suboption of IPA that enables you to use the results from sample program execution to improve optimization near conditional branches and in frequently executed code sections. PDF allows you to gather information about the critical paths and the usage of various parts of the application. PDF passes this information to the compiler so that the optimizer can work to make these critical paths faster. This is a three stage process that involves:

1. Performing a full IPA build with the PDF1 and PDFNAME suboptions
2. Running the trial application with representative data
3. Performing another full IPA build with the PDF2 suboption (the file indicated by PDFNAME holds the profile generated when the code was run in step 2)

**Note:** The trial application built from the IPA(PDF1) compiler option can only be run on the current system.

The following list describes each of the IPA(PDF) suboptions:

**PDF1** An IPA suboption specified during IPA Compile and Link steps. It tells IPA to prepare the application to collect profile information.

**PDF2** An IPA suboption specified during IPA Compile and Link steps. This option tells IPA to use the profile information that is provided when optimizing the application.

### PDFNAME

This IPA suboption should be used with PDF1 and PDF2 to provide the name of the file that will be used for the profile information.

### PDFDIR

This environment variable can be used when using IPA(PDF) in the z/OS UNIX System Services shell. It is used to specify the directory for the profile file.

**Before you begin:** IPA(PDF) requires that you compile the entire application twice and is intended to be used after other debugging and tuning is finished. IPA(PDF) compiles should be performed during one of the last steps before putting the application into production. The following is a list of restrictions that applies to the procedures that follow:

- You must compile the main program with PDF for profiling information to be collected at run time.
- Do not compile or run two different applications that use the same PDFDIR directory at the same time, unless you have used the PDFNAME(filename) option to distinguish the sets of profiling information.
- You must use the same set of compiler options at all compilation steps for a particular program otherwise PDF cannot optimize your program correctly and may even slow it down.
- You must ensure the profiling information that is provided to the compiler during the PDF2 step is for the application you are tuning.
  - If a non-qualified data set name is provided, the same userid that runs the application to collect the profiling information must perform the PDF2 step.
  - If PDFDIR is set for the PDF2 step, it must name a directory where the actual profiling information can be found.
- The profiling information is placed in the file specified by the PDFNAME(filename) suboption, where filename can be a z/OS UNIX System Services file name or a z/OS data set name (physical sequential data set or a member of a partitioned data set). For a data set name, it can be fully qualified such as PDFNAME="//HLQ.PDF" or non-qualified such as PDFNAME=//PDF, in which case the actual data set name will be userid.PDF, where the userid identifies the user who is executing the application built with PDF1 and building the application with PDF2. The key DCB attributes are RECFM=U and LRECL=0. In the z/OS UNIX environment, the profile is placed in the current working directory or in the directory that the PDFDIR environment variable names, if that variable is set. If PDFNAME(filename) is not specified, the default file name is PDFNAME(@@PDF). This file is referred to as the PDF file.
- If PDFNAME is not provided, then you need to ensure that the same environment (z/OS UNIX System Services, batch/TSO, POSIX mode) is used to collect the profiling information and to perform the PDF1 or PDF2 steps. This is because PDFNAME will default to @@PDF and thus the actual location of the file is based on the environment. For example, when the POSIX(ON) run-time option is used, the PDF file will be ./@@PDF and when the POSIX(OFF) run-time option is used, the PDF file will be in data set userid.@@PDF. In order to eliminate unnecessary confusion, it is recommended that an explicit PDF file name always be provided.
- The compiler makes an attempt to delete the PDF file during PDF1 IPA(LINK) processing.
- If PDFNAME names a data set, it is strongly recommended that the data set physically exist and be allocated with sufficient space before step 2 in the process described below. Since the actual space required is based on the complexity of the application and the amount of the test data, you may run into a situation where the pre-allocated space is insufficient and you need to re-allocate the data set with larger space. The recommended attributes for the PDF data set are: RECFM=U LRECL=0.
- If you do compile a program with PDF1, it will generate profiling information when it runs, which involves some performance overhead. This overhead goes away when you recompile with PDF2 or with no PDF (NOPDF1 and NOPDF2).
- The CCNXP1B, CCNPD1B, CCNPD1B, and CCNQPD1B PROCs have been created to help the batch user link with the libraries required for

IPA(PDF1). Unlike our default link PROCs, these PROCs will statically bind the libraries to ensure correct operation of the information capture runs.

- Applications built with IPA(PDF1) should not be put into production because the application will be slower due to the instrumented code. The application will lose its natural reentrancy due to the sharing of the global data between the application and the statically bound PDF run-time code.

Perform the following steps to use IPA(PDF):

1. Compile some or all of the source files in a program with the IPA(PDF1) suboption on both the IPA Compile and IPA Link steps. You need to specify the OPTIMIZE(2) option, or preferably the OPTIMIZE(3) option, and the IPA(LEVEL(1|2)) option. Pay special attention to the compiler options that you use to compile the files, because you will need to use the same options later. In a large application, concentrate on those areas of the code that can benefit most from optimization, which are the paths that are executed most in a typical run of the program. Use sample data for profiling that reflects the typical runs that end users make and then the generated profiling information will show the most used paths, and the optimizer will be able to make these paths as fast as possible. You do not need to compile all of the application's code with the PDF1 suboption but you need to compile the main function with the PDF1 suboption. Link the program using CCNPD1B, CCNXP1B, or CCNQPD1B in batch, or the **-WI,PDF** option in the z/OS UNIX System Services shell.
2. Run the program built from step 1 all the way through using a typical data set. The program records profiling information when it finishes. You can run the program multiple times with different input data sets, and the profiling information is accumulated to provide a count of how often branches are taken and blocks of code are executed, based on the input data sets used.

**Note:** Use data that is representative of the data that will be used during a normal run of your finished program.

3. Re-build your program using the identical set of source files with the identical compiler options that you used in step 1, but change PDF1 to PDF2. This must be done with the same compiler you use in step 1. In this second stage, the accumulated profiling information is used to fine-tune the optimizations. The resulting program does not contain profiling overhead.

PDF1 at IPA Compile step causes IPA to place an indicator in the IPA object so the functions in the compilation unit are instrumented during the IPA Link step. PDF2 at IPA Compile step causes IPA to place an indicator in the IPA object so the functions in the compilation unit are optimized based on the profiling information.

PDF1 at IPA Link step causes IPA to insert instrumentation in the application code. PDF2 at IPA Link step causes IPA to optimize the application based on the profiling information collected in the file specified by PDFNAME.

Refer to "Using the IPA option" in *z/OS XL C/C++ Programming Guide* for an overview, examples, and more details about Interprocedural Analysis.



## KEYWORD | NOKEYWORD

Default: Recognizes all C++ keywords.

| Option Scope |             |          |
|--------------|-------------|----------|
| C Compile    | C++ Compile | IPA Link |
|              | ✓           | ✓        |

**Category:** Programming Language Characteristics Control



The KEYWORD option controls whether a specified *name* is created as a keyword or an identifier whenever it appears in your C++ source. By default, all the built-in keywords defined in the C++ standard are reserved as keywords. You cannot add keywords to the C++ language with this option. However, you can use it to enable built-in keywords that have been disabled using NOKEYWORD(string).

**Note:** The suboption is case-sensitive.

## LANGLVL

Default: LANGLVL(EXTENDED)

For the z/OS UNIX System Services utilities, the defaults are as follows:

- For the **c99** command:
  - LANGLVL(STDC99)
- For the **c89** command:
  - LANGLVL(ANSI)
- For the **cc** command:
  - LANGLVL(COMMONC)
- For the **c++** command:
  - LANGLVL(EXTENDED, NOLIBEXT, NOLONGLONG)

| Option Scope |             |          |
|--------------|-------------|----------|
| C Compile    | C++ Compile | IPA Link |
| ✓            | ✓           | ✓        |

**Category:** Programming Language Characteristics Control for C





The `LANGLVL` option defines a macro that specifies a language level. You must then include this macro in your code to force conditional compilation; for example, with the use of `#ifdef` directives. You can write portable code if you correctly code the different parts of your program according to the language level. You use the macro in preprocessor directives in header files.

The following suboptions are only available under z/OS XL C:

#### COMMONC

It indicates language constructs that are defined by XPG, many of which `LANGLVL(EXTENDED)` already supports. `LANGLVL(ANSI)` and `LANGLVL(EXTENDED)` do not support the following, but `LANGLVL(COMMONC)` does:

- Unsignedness is preserved for standard integral promotions (that is, unsigned char is promoted to unsigned int)
- Trigraphs within literals are not processed
- `sizeof` operator is permitted on bit fields
- Bit fields other than `int` are tolerated, and a warning message is issued
- Macro parameters within quotation marks are expanded
- Macros may be redefined without first being undefined
- The empty comment in a subprogram-like macro is equivalent to the ANSI/ISO token concatenation operator

The macro `__COMMONC__` is defined as 1 when you specify `LANGLVL(COMMONC)`.

If you specify `LANGLVL(COMMONC)`, the `ANSIALIAS` option is automatically turned off. If you want `ANSIALIAS` turned on, you must explicitly specify it.

**Note:** The option `ANSIALIAS` assumes code that supports ANSI. Using `LANGLVL(COMMONC)` and `ANSIALIAS` together may have undesirable effects on your code at a high optimization level. See “`ANSIALIAS | NOANSIALIAS`” on page 69 for more information.

#### EXTC89

Indicates language constructs that are defined by the ISO C89 standard, plus additional orthogonal language extensions that do not alter the behavior of this standard.

#### EXTC99

Indicates language constructs that are defined by the ISO C99 standard, plus additional orthogonal language extensions that do not alter the behavior of the standard.

**SAA** Indicates language constructs that are defined by SAA.

## SAAL2

Indicates language constructs that are defined by SAA Level 2.

## STDC89

Indicates language constructs that are defined by the ISO C89 standard. This suboption is synonymous with `LANGLVL(ANSI)`.

## STDC99

Indicates language constructs that are defined by the ISO C99 standard.

**Note:** The following list shows ISO C99 language constructs unavailable with `LANGLVL(EXTENDED)` or `LANGLVL(EXTC89)`:

- `inline` keyword
- `restrict` keyword
- C++ style comments

Unsuffixed integer literals are handled differently under ISO C99 than they are for `LANGLVL(EXTENDED)` or `LANGLVL(EXTC89)`. Unsuffixed integer literals with values greater than `INT_MAX`, have a `long long` type under ISO C99 and an `unsigned int` type under `LANGLVL(EXTENDED)` or `LANGLVL(EXTC89)`.

The following suboptions are available under z/OS XL C and z/OS XL C++:

## EXTENDED

It indicates all language constructs are available with z/OS XL C. It enables extensions to the ISO C standard. The macro `__EXTENDED__` is defined as 1.

**ANSI** Use it if you are compiling new or ported code that is ISO C/C++ compliant. It indicates language constructs that are defined by ISO. Some non-ANSI stub routines will exist even if you specify `LANGLVL(ANSI)`, for compatibility with previous releases. The macro `__ANSI__` is defined as 1 for C only. It ensures that the compilation conforms to the ISO C and C++ standards.

**Note:** When you specify `LANGLVL(ANSI)`, the compiler can still read and analyze the `_Packed` keyword in z/OS XL C/C++. If you want to make your code purely ANSI, you should redefine `_Packed` in a header file as follows:

```
#ifdef __ANSI__
#define _Packed
#endif
```

The compiler will now see the `_Packed` attribute as a blank when `LANGLVL(ANSI)` is specified at compile time, and the language level of the code will be ANSI.

## LIBEXT | NOLIBEXT

Specifying this option affects the C/C++ run-time provided headers, which in turn control the availability of general ISO run-time extensions. In addition, it also defines the following macros and sets their values to 1:

- `_MI_BUILTIN` (this macro controls the availability of machine built-in instructions. Refer to the section on using built-in functions in *z/OS XL C/C++ Programming Guide*)
- `_EXT` (this macro controls the availability of general ISO run-time extensions)

The default for C is LANG(LIBEXT) and for C++ is LANG(NOLIBEXT). However, LANG(LIBEXT) is implicitly enabled in C by LANG(COMMONC | SAA | SAAL2 | EXTENDED | EXTC89 | EXTC99) and in C++ by LANG(EXTENDED | COMPAT92).

#### LONGLONG | NOLONGLONG

This option controls the availability of long long integer types for your compilation. The default for C is LANG(LONGLONG) and for C++ is LANG(NOLONGLONG).

**Category:** Programming Language Characteristics Control for C++

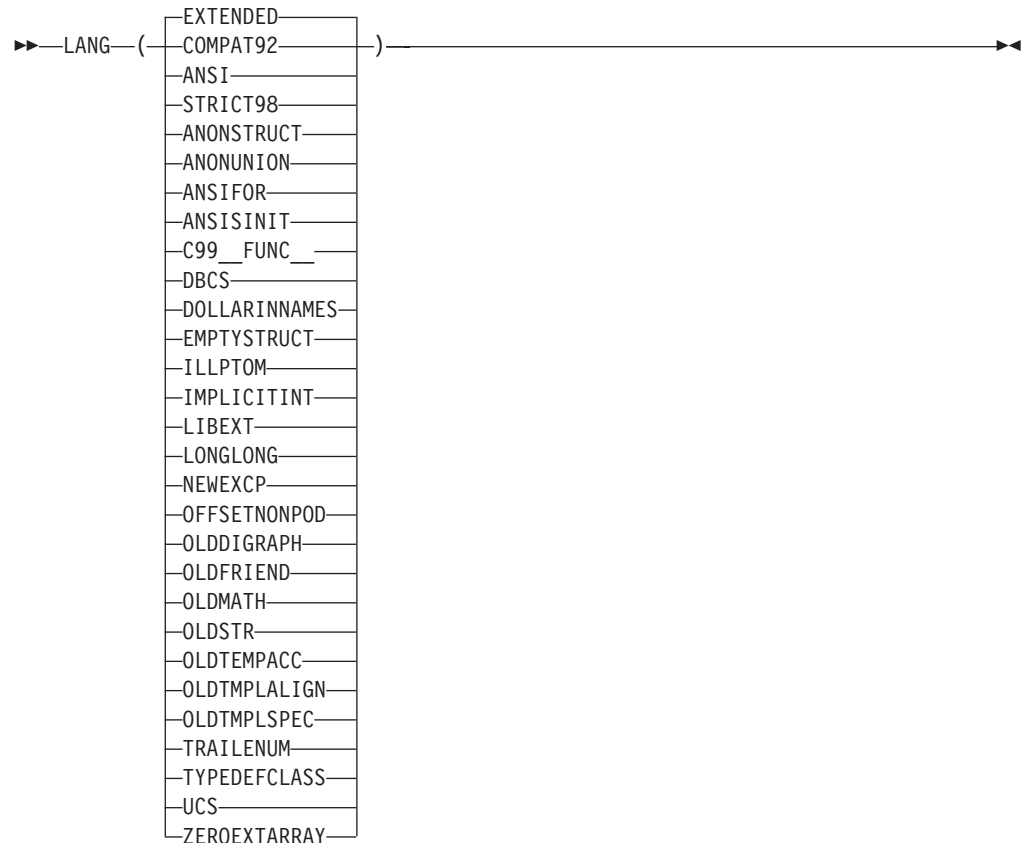

Three predefined option groups are provided for commonly used settings for C++. These groups are:

#### LANGLVL(COMPAT92)

Use this option group if your code compiles with z/OS V1R1 and you want to move to z/OS V1R2 with minimal changes. This group is the closest you can get to the old behavior of the previous compilers.

#### LANGLVL(STRICT98) or LANGLVL(ANSI)

These two option groups are identical. Use them if you are compiling new or ported code that is ISO C++ compliant. They indicate language constructs that are defined by ISO. Some non-ANSI stub routines will exist even if you specify LANGLVL(ANSI), for compatibility with previous releases.

## LANGLVL(EXTENDED)

This option group indicates all language constructs available with z/OS XL C++. It enables extensions to the ISO C/C++ standard. The macro `__EXTENDED__` is defined as 1.

The options and settings included in the COMPAT92, STRICT98/ANSI, and EXTENDED groups are listed in the table below. Except for TEMPLPARSE, all settings have a value of either on (meaning the suboption or option is enabled) or off (meaning the suboption or option is not enabled).

Table 22. Compatibility options for z/OS XL C++ compiler

| Options                                      | Group names |                |          |
|--|-------------|----------------|----------|
|  | compat92    | strict98/ ansi | extended |
| KEYWORD(bool)  <br>NOKEYWORD(bool)           | Off         | On             | On       |
| KEYWORD(explicit)  <br>NOKEYWORD(explicit)   | Off         | On             | On       |
| KEYWORD(export)  <br>NOKEYWORD(export)       | Off         | On             | On       |
| KEYWORD(false)  <br>NOKEYWORD(false)         | Off         | On             | On       |
| KEYWORD(mutable)  <br>NOKEYWORD(mutable)     | Off         | On             | On       |
| KEYWORD(namespace)  <br>NOKEYWORD(namespace) | Off         | On             | On       |
| KEYWORD(true)  <br>NOKEYWORD(true)           | Off         | On             | On       |
| KEYWORD(typename)  <br>NOKEYWORD(typename)   | Off         | On             | On       |
| KEYWORD(using)  <br>NOKEYWORD(using)         | Off         | On             | On       |
| LANGLVL(ANONSTRUCT  <br>NOANONSTRUCT)        | Off         | Off            | On       |
| LANGLVL(ANONUNION  <br>NOANONUNION)          | On          | Off            | On       |
| LANGLVL(ANSIFOR   NOANSIFOR)                 | Off         | On             | On       |
| LANGLVL(ANSISINIT  <br>NOANSISINIT)          | Off         | On             | On       |
| LANGLVL(C99__FUNC__  <br>NOC99__FUNC__)      | Off         | Off            | On       |
| LANGLVL(EMPTYSTRUCT  <br>NOEMPTYSTRUCT)      | On          | Off            | On       |
| LANGLVL(ILLPTOM   NOILLPTOM)                 | On          | Off            | On       |
| LANGLVL(IMPLICITINT  <br>NOIMPLICITINT)      | On          | Off            | On       |
| LANGLVL(LIBEXT   NOLIBEXT)                   | On          | Off            | On       |
| LANGLVL(LONGLONG  <br>NOLONGLONG)            | On          | Off            | On       |
| LANGLVL(OFFSETNONPOD  <br>NOOFFSETNONPOD)    | On          | Off            | On       |

Table 22. Compatibility options for z/OS XL C++ compiler (continued)

| Options                                | Group names |                |          |
|--|-------------|----------------|----------|
|  | compat92    | strict98/ ansi | extended |
| LANGLVL(OLDDIGRAPH   NOOLDDIGRAPH)     | Off         | On             | Off      |
| LANGLVL(OLDFRIEND   NOOLDFRIEND)       | On          | Off            | On       |
| LANGLVL(OLDMATH   NOOLDMATH)           | On          | Off            | Off      |
| LANGLVL(OLDSTR   NOOLDSTR)             | On          | Off            | Off      |
| LANGLVL(OLDTEMPACC   NOOLDTEMPACC)     | On          | Off            | On       |
| LANGLVL(OLDTMPLALIGN   NOOLDTMPLALIGN) | On          | Off            | Off      |
| LANGLVL(OLDTMPLSPEC   NOOLDTMPLSPEC)   | On          | Off            | On       |
| LANGLVL(TRAIENUM   NOTRAIENUM)         | On          | Off            | On       |
| LANGLVL(TYPEDEFCLASS   TYPEDEFCLASS)   | On          | Off            | On       |
| LANGLVL(ZEROEXTARRAY   NOZEROEXTARRAY) | Off         | Off            | On       |
| RTTI   NORTTI                          | Off         | On             | On       |
| TMPLPARSE(NO   ERROR   WARN)           | NO          | WARN           | NO       |

You can control individual language features in the z/OS V1R2 C++ compiler by using the LANGLVL and KEYWORD suboptions listed in Table 22 on page 136. In order to conform to the ISO C++ standard, you may need to make a number of changes to your existing source code. These suboptions can help by breaking up the changes into smaller steps.

For C++, the following suboptions apply:

**Note:** The group options override the individual suboptions so if you want to specify a suboption it should be after a group option. For example, if you specify LANG(ANSIFOR,COMPAT92) you will get LANG(NOANSIFOR) because the LANG(COMPAT92) specifies NOANSIFOR. Thus you should specify LANG(COMPAT92,ANSIFOR) to get ANSIFOR.

#### ANONSTRUCT | NOANONSTRUCT

This option controls whether anonymous structs and anonymous classes are allowed in your C++ source. When LANG(ANONSTRUCT) is specified, z/OS XL C++ allows anonymous structs. This is an extension to the C++ standard.

**Example:** Anonymous structs typically are used in unions, as in the following code example:

```
union U {
    struct {
        int i:16;
        int j:16;
    };
};
```

```

    int k;
} u;
// ...
u.j=3;

```

When LANG(ANONSTRUCT) is in effect, you receive a warning if your code declares an anonymous struct. You can suppress the warning with SUPPRESS(CCN5017). When you build with LANG(NOANONSTRUCT) an anonymous struct is flagged as an error. Specify LANG(NOANONSTRUCT) for compliance with ISO standard C++. The default is LANG(ANONSTRUCT).

#### ANONUNION | NOANONUNION

This option controls what members are allowed in anonymous unions. When LANG(ANONUNION) is in effect, anonymous unions can have members of all types that ISO standard C++ allows in non-anonymous unions. For example, non-data members, such as structs, typedefs, and enumerations are allowed. Member functions, virtual functions, or objects of classes that have non-trivial default constructors, copy constructors, or destructors cannot be members of a union, regardless of the setting of this option. When LANG(ANONUNION) is in effect, z/OS XL C++ allows non-data members in anonymous unions. This is an extension to ISO standard C++. When LANG(ANONUNION) is in effect, you receive a warning if your code uses the extension, unless you suppress the message with SUPPRESS(CCN6608). Specify LANG(NOANONUNION) for compliance with ISO standard C++. The default is LANG(ANONUNION).

#### ANSIFOR | NOANSIFOR

This option controls whether scope rules defined in the C++ standard apply to names declared in for-init statements. By default, ISO standard C++ rules are used.

**Example:** The following code causes a name lookup error:

```

{
  //...
  for (int i=1; i<5; i++) {
    cout << i * 2 << endl;
  }
  i = 10; // error
}

```

The reason for the error is that *i*, or any name declared within a for-init-statement, is visible only within the for statement. To correct the error, either declare *i* outside the loop or specify LANG(NOANSIFOR). Specify LANG(NOANSIFOR) to allow old language behavior. The default is LANG(ANSIFOR).

#### ANSISINIT | NOANSISINIT

This suboption can be used to select between the old (prior to z/OS V1R1) and the current (z/OS V1R2 or later) compiler behaviors. It is useful for building an application that includes an existing DLL originally built with a z/OS V1R1 or earlier version of the z/OS XL C/C++ compilers. Specifying the NOANSISINIT suboption, ensures that the behavior of global (including static locals) objects with destructors in the newly-compiled objects is compatible with objects built with earlier compilers.

If you specify the LP64 option and the LANGLVL(NOANSISINIT) option, the compiler issues a warning, ignores the LANGLVL(NOANSISINIT) option and turns on the LANGLVL(ANSISINIT) option.

The default setting is LANGLVL(ANSISINIT).

**Note:** LANGLVL(EXTENDED) and LANVLVL(ANSI) set LANGLVL(ANSISINIT). LANGLVL(COMPAT92) sets LANGLVL(NOANSISINIT).

C99\_\_FUNC\_\_ | NOC99\_\_FUNC\_\_

This option provides an alternative method for debugging programs by identifying the names of functions where the \_\_func\_\_ identifier is used.

DBCS | NODBCS

This option controls whether multi-byte characters are accepted in string literals and in comments. The default is LANG(NODBCS).

DOLLARINNAMES | NODOLLARINNAMES

This option controls whether the dollar-sign character (\$) is allowed in identifiers. If LANG(NODOLLARINNAMES) is in effect, dollar sign characters in identifiers are treated as syntax errors. The default is LANG(NODOLLARINNAMES).

EMPTYSTRUCT | NOEMPTYSTRUCT

This option instructs the compiler to tolerate empty member declarations in structs. ISO C++ does not permit empty member declaration in structs.

**Example:** When LANG(NOEMPTYSTRUCT) is in effect, the following example will be rejected by the compiler:

```
struct S {  
    ; // this line is ill-formed  
};
```

The default is LANG(NOEMPTYSTRUCT).

ILLPTOM | NOILLPTOM

This controls what expressions can be used to form pointers to members. The compiler accepts some forms that are in common use, but do not conform to the C++ standard. When LANG(ILLPTOM) is in effect, the compiler allows these forms.

**Example:** The following code defines the pointer to a function member, p, and initializes the address of C::foo, in the old style:

```
struct C {  
    void foo(int);  
};  
  
void (C::*p) (int) = C::foo;
```

Specify LANG(NOILLPTOM) for compliance with the C++ standard.

**Example:** The example must be modified to use the & operator:

```
struct C {  
    void foo(int);  
};  
  
void (C::*p) (int) = &C::foo;
```

The default is LANG(ILLPTOM).

IMPLICITINT | NOIMPLICITINT

This option controls whether z/OS XL C++ will accept missing or partially specified types as implicitly specifying int. This is no longer accepted in the standard but may exist in legacy code. When LANG(NOIMPLICITINT) is

specified, all types must be fully specified. Also, when LANG(IMPLICITINT) is specified, a function declaration at namespace scope or in a member list will implicitly be declared to return int. Also, any declaration specifier sequence that does not completely specify a type will implicitly specify an integer type. Note that the effect is as if the int specifier were present. This means that the specifier const, by itself, would specify a constant integer. The following specifiers do not completely specify a type:

- auto
- const
- extern
- extern "<literal>"
- inline
- mutable
- friend
- register
- static
- typedef
- virtual
- volatile
- platform specific types (for example, \_cdecl, \_\_declspec)

Note that any situation where a type is specified is affected by this option. This includes, for example, template and parameter types, exception specifications, types in expressions (eg, casts, dynamic\_cast, new), and types for conversion functions. By default, LANG(EXTENDED) sets LANG(IMPLICITINT). This is an extension to the C++ standard.

**Example:** The return type of function MyFunction is int because it was omitted in the following code:

```
MyFunction()
{
    return 0;
}
```

Specify LANG(NOIMPLICITINT) for compliance with ISO standard C++.

**Example:** The function declaration above must be modified to:

```
int MyFunction()
{
    return 0;
}
```

The default is LANG(IMPLICITINT).

#### NEWEXCP | NONEWEXCP

This option determines whether or not the C++ operator new throws an exception. When LANGLVL(NEWEXCP) is specified, the standard exception std::bad\_alloc is thrown when the requested memory allocation fails. This option does not apply to the nothrow versions of the new operator. The default setting is NONEWEXCP. This option governs the behavior of the default versions of the standard new operators. This option does apply to the throw versions of the new operator except for class-specific new operators, user-defined new operators, and new operators with placement arguments.



## OFFSETNONPOD | NOOFFSETNONPOD

This option controls whether the `offsetof` macro can be applied to classes that are not data-only. C++ programmers often casually call data-only classes "Plain Old Data" (POD) classes. By default, `LANG(EXTENDED)` allows `offsetof` to be used with non-POD classes. This is an extension to the C++ standard. When `LANG(OFFSETNONPOD)` is in effect, you receive a warning if your code uses the extension, unless you suppress the message with `SUPPRESS(CCN6281)`. Specify `LANG(NOOFFSETNONPOD)` for compliance with ISO standard C++. Specify `LANG(OFFSETNONPOD)` if your code applies `offsetof` to a class that contains one of the following:

- User-declared constructors or destructors
- User-declared assignment operators
- Private or protected non-static data members
- Base classes
- Virtual functions
- Non-static data members of type pointer to member
- A struct or union that has non-data members
- References

The default is `LANG(OFFSETNONPOD)`.

## OLDDIGRAPH | NOOLDDIGRAPH

This option controls whether old-style digraphs are allowed in your C++ source. It applies only when `DIGRAPH` is also set. When `LANG(NOOLDDIGRAPH)` is specified, z/OS XL C++ supports only the digraphs specified in the C++ standard. Set `LANG(OLDDIGRAPH)` if your code contains at least one of following digraphs:

- `%%` digraph, which results in `#` (pound sign)
- `%%%` digraph, which results in `##` (double pound sign, used as the preprocessor macro concatenation operator)

Specify `LANG(NOOLDDIGRAPH)` for compatibility with ISO standard C++ and the extended C++ language level. The default is `LANG(NOOLDDIGRAPH)`.

## OLDFRIEND | NOOLDFRIEND

This option controls whether friend declarations that name classes without elaborated class names are treated as C++ errors. When `LANG(OLDFRIEND)` is in effect, you can declare a friend class without elaborating the name of the class with the keyword `class`. This is an extension to the C++ standard. For example, the statement below declares the class `IFont` to be a friend class and is valid when `LANG(OLDFRIEND)` is in effect.

```
friend IFont;
```

The example declaration above causes a warning unless you modify it to the statement below, or suppress the message with the `SUPPRESS(CCN5070)` option. Specify `LANG(NOOLDFRIEND)` for compliance with ISO standard C++. Specifying this option will cause an error condition and message to be generated for the example declaration above.

```
friend class IFont;
```

The default for batch and TSO is `LANG(OLDFRIEND)`.

## OLDMATH | NOOLDMATH

This option controls which math function declarations are introduced by the `math.h` header file. For conformance with the C++ standard, the `math.h` header file declares several new functions that were not declared by `math.h` in previous releases. These new function declarations may cause an existing program to become invalid and, therefore, to fail to compile. This occurs because the new function declarations introduce the possibility of ambiguities in function overload resolution. The `OLDMATH` option specifies that these new function declarations are not to be introduced by the `math.h` header file, thereby significantly reducing the possibility of ambiguous overload resolution. The default is `LANG(NOOLDMATH)`.

## OLDSTR | NOOLDSTR

This option provides backward compatibility with previous versions of z/OS XL C++ and predecessor products, by controlling which string function declarations are introduced by the `string.h` and `wchar.h` header files. For conformance with the current C++ standard, `string.h` and the `wchar.h` header files declare several C++ string functions differently for C++ source files than they were declared in previous releases. These new function declarations may cause an existing C++ program to become invalid and therefore fail to compile. The `LANG(OLDSTR)` option specifies that the new C++ string function declarations are not to be introduced by the `string.h` and `wchar.h` header files, thereby causing only the C versions of these functions to be declared, as in previous releases. Note that when a C source file is compiled, these declarations remain unchanged from previous releases.

A number of the string function signatures that are defined in the 1989 C International Standard and the C Amendment are not `const`-safe.

**Example:** Consider the following standard C signature:

```
char * strchr(const char *s, int c);
```

The behavior of this function is specified as follows:

- The `strchr` function locates the first occurrence of `c` (converted to a `char`) in the string pointed to by `s`. The terminating null character is considered to be part of the string.
- The `strchr` function returns a pointer to the located character, or a null pointer if the character does not occur in the string.

Since the parameter `s` is of type `const char *`, the string being searched by the `strchr` function is potentially composed of characters whose type is `const char`. The `strchr` function returns a pointer to one of the constituent characters of the string, but this pointer is of type `char *` even though the character that it points to is potentially of type `const char`. For this reason, `strchr` can be used to implicitly (and unintentionally) defeat the `const`-qualification of the string referenced by the pointer `s`.

**Example:** To correct this problem, the C++ standard replaces the above signature from the C standard with the following overloaded signatures:

```
const char * strchr(const char *s, int c);  
char * strchr(char *s, int c);
```

Both of these overloaded functions have the same behavior as the original C version of `strchr`.

In a similar manner, the signatures of several other standard C library routines are replaced in the C++ standard. The affected routines are:

- strchr
- strpbrk
- strrchr
- strstr
- memchr
- wcschr
- wcpbrk
- wcsrchr
- wcsstr
- wmemchr

**Example:** Because of the changes mandated by the C++ standard, the following unsafe example will not compile in C++:

```
#include <string.h>

const char s[] = "foobar";

int main(void) {
    char * c = strchr(s, 'b');
}
```

To preserve backward compatibility with previous releases (and thus enable the code example above), specify `LANGLVL(OLDSTR)`.

#### OLDTEMPACC | NOOLDTEMPACC

This option controls whether access to a copy constructor to create a temporary object is always checked, even if creation of the temporary object is avoided. When `LANG(NOOLDTEMPACC)` is in effect, z/OS XL C++ suppresses the access checking. This is an extension to the C++ standard. When `LANG(OLDTEMPACC)` is in effect, you receive a warning if your code uses the extension, unless you disable the message. Disable the message by building with `SUPPRESS(CCN5306)` when the copy constructor is a private member, and `SUPPRESS(CCN5307)` when the copy constructor is a protected member. Specify `LANG(NOOLDTEMPACC)` for compliance with ISO standard C++.

**Example:** The throw statement in the following code causes an error because the copy constructor is a protected member of class C:

```
class C {
public:
    C(char *);
protected:
    C(const C&);
};

C foo() {return C("test");} // returns a copy of a C object

void f()
{
// catch and throw both make implicit copies of the thrown object
    throw C("error"); // throws a copy of a C object
    const C& r = foo(); // uses the copy of a C object created by foo()
}
```

The example code above contains three ill formed uses of the copy constructor `C(const C&)`. The default is `LANG(OLDTEMPACC)`.

#### OLDTMPLALIGN | NOOLDTMPLALIGN

This option specifies the alignment rules implemented by the compiler for

nested templates. Previous versions of the compiler ignored alignment rules specified for nested templates. By default, LANG(EXTENDED) sets LANG(NOOLDTMPLALIGN) so the alignment rules are not ignored. The default for is LANG(NOOLDTMPLALIGN).

#### OLDTMPLSPEC | NOOLDTMPLSPEC

This option controls whether template specializations that do not conform to the C++ standard are allowed. When LANG(NOOLDTMPLSPEC) is in effect, z/OS XL C++ allows these old specializations. This is an extension to ISO standard C++. When LANGLVL(OLDTMPLSPEC) is set, you receive a warning if your code uses the extension, unless you suppress the message with SUPPRESS(CCN5080).

**Example:** You can explicitly specialize the template class ribbon for type char with the following lines:

```
template<classT> class ribbon { /*...*/};  
class ribbon<char> { /*...*/};
```

Specify LANG(NOOLDTMPLSPEC) for compliance with standard C++. In the example above, the template specialization must be modified to:

```
template<class T> class ribbon { /*...*/};  
template<> class ribbon<char> { /*...*/};
```

The default is LANG(OLDTMPLSPEC).

#### TRAIENUM | NOTRAIENUM

This option controls whether trailing commas are allowed in enum declarations. When LANG(TRAIENUM) is in effect, z/OS XL C++ allows one or more trailing commas at the end of the enumerator list. This is an extension to the C++ standard. The following enum declaration uses this extension:

```
enum grain { wheat, barley, rye,, };
```

Specify LANG(NOTRAIENUM) for compliance with the ISO C and C++ standards. The default is LANG(TRAIENUM).

#### TYPEDEFCLASS | NOTYPEDEFCLASS

This option provides backwards compatibility with previous versions of z/OS XL C++ and predecessor products. The current C++ standard does not allow a typedef name to be specified where a class name is expected. This option relaxes that restriction. Specify LANG(TYPEDEFCLASS) to allow the use of typedef names in base specifiers and constructor initializer lists. When LANG(NOTYPEDEFCLASS) is in effect, a typedef name cannot be specified where a class name is expected. The default is LANG(TYPEDEFCLASS).

#### UCS | NOUCS

This option controls whether Unicode characters are allowed in identifiers, string literals and character literals in C++ sources. The Unicode character set is supported by the C++ standard. This character set contains the full set of letters, digits and other characters used by a wide range of languages, including all North American and Western European languages. Unicode characters can be 16 or 32 bits. The ASCII one-byte characters are a subset of the Unicode character set. When LANG(UCS) is in effect, you can insert Unicode characters in your source files either directly or using a notation that is similar to escape sequences. Because many Unicode characters cannot be displayed on the screen or entered from the keyboard, the latter approach is usually preferred. Notation forms for

Unicode characters are \uhhhh for 16-bit characters, or \Uhhhhhhh for 32-bit characters, where h represents a hexadecimal digit. Short identifiers of characters are specified by ISO/IEC 10646. The default is LANG(NUCS).

|  
|  
|  
|  
|

**Note:** The C99 specification has added the use of universal character names within identifiers and the set of restrictions differs from C++. LANG(UCS) supports the union of valid universal character name ranges from the current C++ specification and the new C99 specification.

#### ZEROEXTARRAY | NOZEROEXTARRAY

This option controls whether zero-extent arrays are allowed as the last non-static data member in a class definition. When LANG(ZEROEXTARRAY) is in effect, z/OS XL C++ allows arrays with zero elements. This is an extension to the C++ standard.

**Example:** The example declarations below define dimensionless arrays a and b:

```
struct S1 { char a[0]; };
struct S2 { char b[]; };
```

|  
|

Specify LANG(NOZEROEXTARRAY) for compliance with the ISO C++ standard. When LANG(ZEROEXTARRAY) is set, you receive informational messages about zero-extent arrays in your code, unless you suppress the message with SUPPRESS(CCN6607). The default is LANG(ZEROEXTARRAY).

## LIBANSI | NOLIBANSI

Default: NOLIBANSI

| Option Scope |             |          |
|--------------|-------------|----------|
| C Compile    | C++ Compile | IPA Link |
| ✓            | ✓           | ✓        |

**Category:** Object Code Control



The LIBANSI option indicates whether the functions with the name of an ISO C library function are in fact ISO C library functions. If you specify LIBANSI, the compiler generates code that is based on existing knowledge concerning the behavior of the ISO C library function; for example, whether or not any side effects are associated with a particular system function.

A comment that indicates the use of the LIBANSI option will be generated in your object module to aid you in diagnosing your program.

You can specify this option using the **#pragma options** directive for C.

## Effect on IPA Compile step

If you specify the LIBANSI option for any compilation unit in the IPA Compile step, the compiler generates information for the IPA Link step. This option also affects the regular object module if you request one by specifying the IPA(OBJECT) option.

## Effect on IPA Link step

The LIBANSI option will be in effect for the IPA Link step unless the NOLIBANSI option is specified. The value of the LIBANSI option from the IPA Compile step is ignored, but is shown in the IPA Link listing Compile Option Map for reference.

## LIST | NOLIST

Default: NOLIST

In the z/OS UNIX System Services environment, this option is turned on by specifying -V when using the **c89**, **cc** or **c++** commands. -V produces all reports for the compiler, and binder, or prelinker, and directs them to stdout. To produce only the listing (and no other reports), and write the listing to a user-specified file, use the following command:

```
-Wc,"LIST(filename)"
```

| Option Scope |             |          |
|--------------|-------------|----------|
| C Compile    | C++ Compile | IPA Link |
| ✓            | ✓           | ✓        |

**Category:** Listing

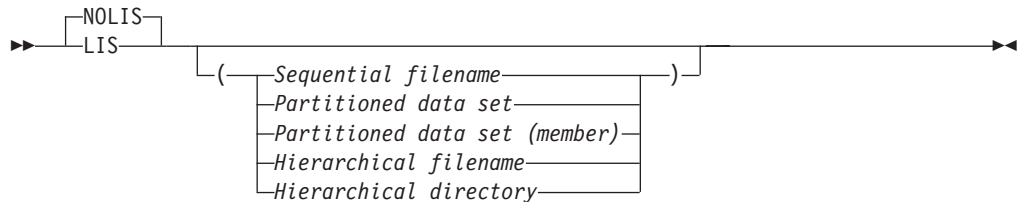

The LIST option instructs the compiler to generate a listing of the machine instructions in the object module (in a format similar to assembler language instructions) in the compiler listing.

LIST(*filename*) places the compiler listing in the specified file. If you do not specify a file name for the LIST option, the compiler uses the SYSCPRT ddname if you allocated one. Otherwise, the compiler generates a file name as follows:

- If you are compiling a data set, the compiler uses the source file name to form the name of the listing data set. The high-level qualifier is replaced with the userid under which the compiler is running, and .LIST is appended as the low-level qualifier.
- If you are compiling a z/OS UNIX file, the compiler stores the listing in a file that has the name of the source file with .lst extension.

The NOLIST option optionally takes a *filename* suboption. This *filename* then becomes the default. If you subsequently use the LIST option without a *filename* suboption, the compiler uses the *filename* that you specified in the earlier NOLIST. For example, the following specifications have the same effect:

```
CXX HELLO (NOLIST(/hello.lst) LIST
```

```
CXX HELLO (LIST(/hello.1is)
```

If you specify data set names in a C or C++ program, with the SOURCE, LIST or INLRPT options, all the listing sections are combined into the last data set name specified.

**Notes:**

1. Usage of information such as registers, pointers, data areas, and control blocks that are shown in the object listing are not programming interface information.
2. If you use the following form of the command in a JES3 batch environment where xxx is an unallocated data set, you may get undefined results.  
LIST(xxx)
3. Statement line numbers exceeding 99999 will wrap back to 00000 for the generated assembly listing for the C/C++ source file. This may occur when the compiler LIST option is used.

**Effect on IPA Compile step**

If you specify the LIST option on the IPA Compile step, the compiler saves information about the source file and line numbers in the IPA object file. This information is available during the IPA Link step for use by the LIST or GONUMBER options.

If you do not specify the GONUMBER option on the IPA Compile step, the object file produced contains the line number information for source files that contain function begin, function end, function call, and function return statements. This is the minimum line number information that the IPA Compile step produces. You can then use the TEST option on the IPA Link step to generate corresponding test hooks.

Refer to “Interactions between compiler options and IPA suboptions” on page 47 and “GONUMBER | NOGONUMBER” on page 111 for more information.

**Effect on IPA Link step**

If you specify the LIST option, the IPA Link listing contains a Pseudo Assembly section for each partition that contains executable code. Data-only partitions do not generate a Pseudo Assembly listing section.

The source file and line number shown for each object code statement depend on the amount of detail the IPA Compile step saves in the IPA object file, as follows:

- If you specified the GONUMBER, LIST, IPA(GONUMBER), or IPA(LIST) option for the IPA Compile step, the IPA Link step accurately shows the source file and line number information.
- If you did not specify any of these options on the IPA Compile step, the source file and line number information in the IPA Link listing or GONUMBER tables consists only of the following:
  - function entry, function exit, function call, and function call return source lines. This is the minimum line number information that the IPA Compile step produces.
  - All other object code statements have the file and line number of the function entry, function exit, function call, and function call return that was last encountered. This is similar to the situation of encountering source statements within a macro.

Refer to “Interactions between compiler options and IPA suboptions” on page 47 and “GONUMBER | NOGONUMBER” on page 111 for more information.



# LOCALE | NOLOCALE

Default: NOLOCALE

For the z/OS UNIX System Services utilities, the default for a regular compile is LOCALE(POSIX). The utilities pick up the locale value of the environment using `setlocale(LC_ALL, NULL)`. Because the compiler runs with the POSIX(OFF) option, categories that are set to C are changed to POSIX.

| Option Scope |             |          |
|--------------|-------------|----------|
| C Compile    | C++ Compile | IPA Link |
| ✓            | ✓           | ✓        |

**Category:** Preprocessor



The LOCALE option specifies the locale to be used by the compiler as the current locale throughout the compilation unit. To specify a locale, use the following format:

LOCALE(*name*)

The suboption *name* indicates the name of the locale to be used by the compiler at compile time. If you omit *name*, the compiler uses the current default locale in the environment. If *name* does not represent a valid locale name, the compiler ignores the LOCALE, and assumes NOLOCALE.

NOLOCALE indicates that the compiler only uses the default code page, which is IBM-1047.

You can specify it on the command line or in the PARMs list in the JCL.

If you specify the LOCALE option, the locale name and the associated code set appear in the header of the listing. A locale name is also generated in the object module.

The LC\_TIME category of the current locale controls the format of the time and the date in the compiler-generated listing file. The identifiers that appear in the tables in the listing file are sorted as specified by the LC\_COLLATE category of the locale specified in the option.

**Note:** The formats of the predefined macros `__DATE__`, `__TIME__`, and `__TIMESTAMP__` are not locale-sensitive.

For more information on locales, refer to *z/OS XL C/C++ Programming Guide*.

## Effect on IPA Compile step

The LOCALE option controls processing only for the IPA step for which you specify it.

During the IPA Compile step, the compiler converts source code using the code page that is associated with the locale specified by the LOCALE compile-time



option. As with non-IPA compilations, the conversion applies to identifiers, literals, and listings. The locale that you specify on the IPA Compile step is recorded in the IPA object file.

You should use the same code page for IPA Compile step processing for all of your program source files. This code page should match the code page of the run-time environment. Otherwise, your application may not run correctly.

### Effect on IPA Link step

The locale that you specify on the IPA Compile step does not determine the locale that the IPA Link step uses. The LOCALE option that you specify on the IPA Link step is used for the following:

- The encoding of the message text and the listing text.
- Date and time formatting in the Source File Map section of the listing and in the text in the object comment string that records the date and time of IPA Link step processing.
- Sorting of identifiers in listings. The IPA Link step uses the sort order associated with the locale for the lists of symbols in the Inline Report (Summary), Global Symbols Map, and Partition Map listing sections.

If the code page you used for a compilation unit for the IPA Compile step does not match the code page you used for the IPA Link step, the IPA Link step issues an informational message.

If you specify the IPA(MAP) option, the IPA Link step displays information about the LOCALE option, as follows:

- The Prolog section of the listing displays the LOCALE or NOLOCALE option. If you specified the LOCALE option, the Prolog displays the locale and code set that are in effect.
- The Compiler Options Map listing section displays the LOCALE option active on the IPA Compile step for each IPA object. If you specified conflicting code sets between the IPA Compile and IPA Link steps, the listing includes a warning message after each Compiler Options Map entry that displays a conflict.
- The Partition Map listing section shows the current LOCALE option.

## LONGNAME | NOLONGNAME

Default: For C, the default option is NOLONGNAME. For C++, the default option is LONGNAME.

For the z/OS UNIX System Services utilities, the default for a regular compile is LONGNAME.

| Option Scope |             |          |
|--------------|-------------|----------|
| C Compile    | C++ Compile | IPA Link |
| ✓            | ✓           | ✓        |

**Category:** Object Code Control

For C:



For C++:



The LONGNAME option generates untruncated and mixed case external names in the object module produced by the compiler for functions with non-C++ linkage. Functions with C++ linkage are always untruncated and mixed-case external names. These names may be up to 1024 characters in length. The system binder recognizes the format of long external names in object modules, but the system linkage editor does not.

For z/OS XL C, if you specify the ALIAS option with LONGNAME, the compiler generates a NAME control statement, but no ALIAS control statements.

If you use **#pragma map** to associate an external name with an identifier, the compiler generates the external name in the object module. That is, **#pragma map** has the same behavior for the LONGNAME and NOLONGNAME compiler options. Also, **#pragma csect** has the same behavior for the LONGNAME and NOLONGNAME compiler options.

When you specify NOLONGNAME, only those functions that do not have C++ linkage are given truncated and uppercase names.

A comment that indicates the setting of the LONGNAME option will be generated in your object module to aid you in diagnosing your program.

**Note:** You must specify either the LONGNAME compiler option or the **#pragma longname** preprocessor directive whenever the HOT option is specified. Otherwise, the compiler issues an unrecoverable error diagnostic message.

### Effect on IPA Compile step

You must specify either the LONGNAME compiler option or the **#pragma longname** preprocessor directive for the IPA Compile step (unless you are using the c89 utility). Otherwise, the compiler issues an unrecoverable error diagnostic message.

### Effect on IPA Link step

The IPA Link step ignores this option if you specify it, and uses the LONGNAME option for all partitions it generates.

## LP64 | ILP32

Default: ILP32. For LP64, the FLOAT option default is IEEE.

| Option Scope |             |          |
|--------------|-------------|----------|
| C Compile    | C++ Compile | IPA Link |
| ↙            | ↙           | ↙        |

**Category:** Object Code Control



The LP64 option instructs the compiler to generate AMODE 64 code utilizing the z/Architecture 64-bit instructions. ILP32 instructs the compiler to generate AMODE 31 code. This is the default and is the same mode as in previous releases of the compiler. LP64 and ILP32 are mutually exclusive. If they are specified multiple times, the compiler will take the last one.

**Note:** AMODE is the addressing mode of the program code generated by the compiler. In AMODE 64 and AMODE 31, 64 and 31 refer to the range of addresses that can be accessed (in other words 64-bits and 31-bits are used to form the address respectively). When there is no ambiguity, we will refer to these as 64-bit mode and 31-bit mode. Refer to the information that follows for further information on the data model.

LP64 and ILP32 refer to the data model used by the language. "I" is an abbreviation that represents int type, "L" represents long type, and "P" represents the pointer type. 64 and 32 refer to the size of the data types. When the ILP32 option is used, int, long and pointers are 32-bit in size. When LP64 is used, long and pointer are 64-bit in size; int remains 32-bit. As explained in a note above, the addressing mode used by LP64 is AMODE 64, and by ILP32 is AMODE 31. In the latter case, only 31 bits within the pointer are taken to form the address. For the sake of conciseness, the terms 31-bit mode and ILP32, will be used interchangeably in this document when there is no ambiguity. The same applies to 64-bit mode and LP64.

The LP64 option requires the XPLINK and GOFF compiler options. It also requires architecture level 5 or above (ARCH(5) or higher). ARCH(5), XPLINK, and GOFF are the default settings for LP64 if you don't explicitly override them. If you explicitly specify NOXPLINK, or NOGOFF, or specify an architecture level lower than 5, the compiler will issue a warning message, ignore NOXPLINK or NOGOFF, and raise the architecture level to 5.

**Notes:**

1. The maximum size of a GOFF object is 1 gigabyte.
2. ARCH(5) specifies the 2064 hardware models.

If LP64 is specified with TARGET(zOSV1R5) or with a TARGET suboption that is prior to zOSV1R5, LP64 is ignored. Also, TARGET(IMS) is not supported; a warning message will be issued.

The prelinker cannot be used with 64-bit object modules.

**Note:** Language Environment does not support mixing 64-bit and 31-bit object files in the same application. If one compilation unit is compiled with LP64, all compilation units within the program must be compiled with LP64. The binder will issue a message if it encounters mixed addressing modes during external name resolution.

In 31-bit mode, the size of long and pointers is 4 bytes and the size of wchar\_t is 2 bytes. Under LP64, the size of long and pointer is 8 bytes and the size of wchar\_t is 4 bytes. The size of other intrinsic datatypes remain the same between 31-bit mode and LP64. Under LP64, the type definition for size\_t changes to long, and the type definition for ptrdiff\_t changes to unsigned long. The following tables give the size of the intrinsic types:

Table 23. Size of intrinsic types in 64-bit mode

| Type   | Size (in bits) |
|--|----------------|
| char, unsigned char, signed char   | 8              |
| short, short int, unsigned short, unsigned short int, signed short, signed short int                         | 16             |
| int, unsigned int, signed int  | 32             |
| long, long int, unsigned long, unsigned long int, signed long, signed long int                               | 64             |
| long long, long long int, unsigned long long, unsigned long long int, signed long long, signed long long int | 64             |
| pointer  | 64             |

Table 24. Size of intrinsic types in 31-bit mode

| Type   | Size (in bits) |
|--|----------------|
| char, unsigned char, signed char   | 8              |
| short, short int, unsigned short, unsigned short int, signed short, signed short int                         | 16             |
| int, unsigned int, signed int  | 32             |
| long, long int, unsigned long, unsigned long int, signed long, signed long int                               | 32             |
| long long, long long int, unsigned long long, unsigned long long int, signed long long, signed long long int | 64             |
| pointer  | 32             |

The `__ptr32` pointer qualifier is intended to make the process of porting applications from ILP32 to LP64 easier. Use this qualifier in structure members to minimize the changes in the overall size of structures. Note that these pointers cannot refer to objects above the 31-bit address line (also known as "the bar"). In general, the program has no control over the address of a variable; the address is assigned by the implementation. It is up to the programmer to make sure that the use of `__ptr32` is appropriate within the context of the program's logic. For more information on the `__ptr32` pointer qualifier, refer to *z/OS XL C/C++ Language Reference*.

**Notes:**

1. The `long` and `wchar_t` data types also change in size.
2. LP64 only supports `OBJECTMODEL(IBM)`.

**Effect on IPA Compile step**

The IPA Compile step generates information for the IPA Link step for ILP32. The LP64 option affects the regular object module if you request one by specifying the `IPA(OBJECT)` option, in which case, the object module generated will be in 64-bit.

**Effect on IPA Link step**

The IPA Link step accepts the LP64 option, but ignores it. The DLL side deck generated by the binder has been enhanced. The side deck contains attribute flags to mark symbols exported from 64-bit DLLs; the flags are `CODE64` and `DATA64` for code and data respectively. IPA recognizes these flags.

The IPA Link step will check that all objects have a consistent data model, either ILP32 or LP64. It checks both IPA object modules and non-IPA object modules. If the IPA Link step finds a mixture of addressing modes among the object files, the compiler issues a diagnostic message and ends the compilation.

## LSEARCH | NOLSEARCH

Default: NOLSEARCH

| Option Scope |             |          |
|--------------|-------------|----------|
| C Compile    | C++ Compile | IPA Link |
| ✓            | ✓           | ✓        |

**Category:** File Management



The LSEARCH option directs the preprocessor to look for the user include files in the specified libraries.

The suboption *path* specifies any of the following:

- The name of a partitioned or sequential data set that contains user include files.
- A z/OS UNIX System Services file system path that contains user include files.
- A search path that is more complex. See “Additional syntax” on page 154 for details.

The #include "*filename*" format of the #include C/C++ preprocessor directive indicates user include files. See “Using include files” on page 316 for a description of the #include preprocessor directive.

For further information on library search sequences, see “Search sequences for include files” on page 325.

### Searching for PDS or PDSE files

**Example:** You coded your include files as follows:

```
#include "sub/fred.h"
#include "fred.inl"
```

You specified LSEARCH as follows:

```
LSEARCH(USER.+,'USERID.GENERAL.+')
```

The compiler uses the following search sequence to look for your include files:

1. First, the compiler looks for sub/fred.h in this data set:  
USERID.USER.SUB.H(FRED)
2. If that PDS member does not exist, the compiler looks in the data set:  
USERID.GENERAL.SUB.H(FRED)
3. If that PDS member does not exist, the compiler looks in DD:USERLIB, and then checks the system header files.
4. Next, the compiler looks for fred.inl in the data set:

USERID.USER.INL(FRED)

5. If that PDS member does not exist, the compiler will look in the data set:

USERID.GENERAL.INL(FRED)

6. If that PDS member does not exist, the compiler looks in DD:USERLIB, and then checks the system header files.

## Searching for z/OS UNIX System Services files

The compiler forms the search path for z/OS UNIX files by appending the path and name of the `#include` file to the path that you specified in the LSEARCH option.

### Example 1

You code `#include "sub/fred.h"` and specify:

```
LSEARCH(/u/mike)
```

The compiler looks for the include file `/u/mike/sub/fred.h`.

### Example 2

You specify your header file as `#include "fred.h"`, and your LSEARCH option as:

```
LSEARCH(/u/mike, ./sub)
```

The compiler uses the following search sequence to look for your include files:

1. The compiler looks for `fred.h` in:

```
/u/mike/fred.h
```

2. If that z/OS UNIX file does not exist, the compiler looks in:

```
./sub/fred.h
```

3. If that z/OS UNIX file does not exist, the compiler looks in the libraries specified on the USERLIB DD statement.

4. If USERLIB DD is not allocated, the compiler follows the search order for system include files.

The NOLSEARCH option instructs the preprocessor to search only those libraries that are specified on the USERLIB DD statement. A NOLSEARCH option cancels all previous LSEARCH specifications, and the compiler uses any LSEARCH options that follow it. When you specify more than one LSEARCH option, the compiler uses all the libraries in these LSEARCH options to find the user include files.

**Note:** If the *filename* in the `#include` directive is in absolute form, the compiler does not perform a search. See “Determining whether the file name is in absolute form” on page 321 for more details on absolute `#include filename`.

## Additional syntax

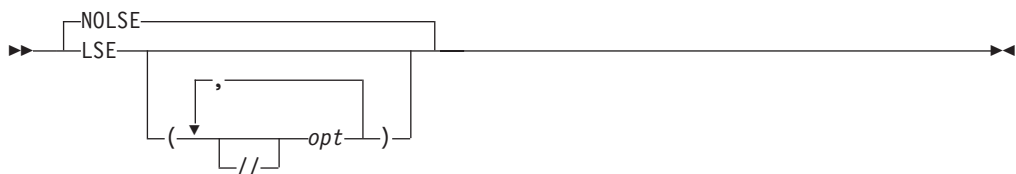

You must use the double slashes (`//`) to specify data set library searches when you specify the OE compiler option. (You may use them regardless of the OE option).

The USERLIB ddname is considered the last suboption for LSEARCH, so that specifying LSEARCH (X) is equivalent to specifying LSEARCH (X,DD:USERLIB).

Parts of the #include *filename* are appended to each LSEARCH *opt* to search for the include file. *opt* has the format:

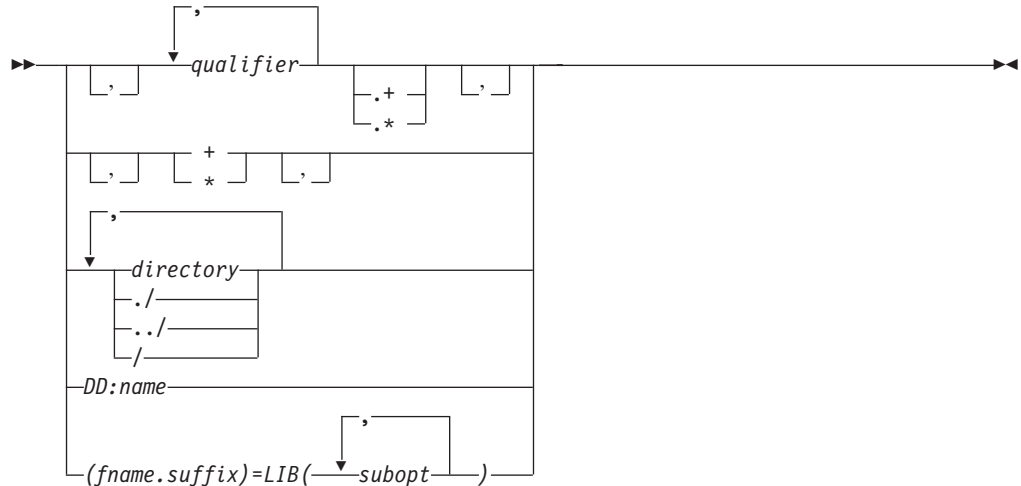

In the above syntax diagram, *opt* specifies one of the following:

- The name of a partitioned or sequential data set that contains user include files
- A z/OS UNIX file system path name that should be searched for the include file. You can also use `./` to specify the current directory and `../` to specify the parent directory for your z/OS UNIX file.
- A DD statement for a sequential data set or a partitioned data set. When you specify a ddname in the search and the include file has a member name, the member name of the include file is used as the name for the DD: *name* search suboption, for example:

```
LSEARCH(DD:NEWLIB)
#include "a.b(c)"
```

The resulting file name is DD:NEWLIB(C).

- A specification of the form  $(fname.suffix) = (subopt, subopt, \dots)$  where:
  - *fname* is the name of the include file, or \*
  - *suffix* is the suffix of the include file, or \*
  - *subopt* indicates a subpath to be used in the search for the include files that match the pattern of *fname.suffix*. There should be at least one *subopt*. The possible values are:
    - LIB(*[pds,...]*) where each *pds* is a partitioned data set name. They are searched in the same order as they are specified.

There is no effect on the search path if no *pds* is specified, but a warning is issued.
    - LIBs are cumulative; for example, LIB(A),LIB(B) is equivalent to LIB(A, B).
    - NOLIB specifies that all LIB(...) previously specified for this pattern should be ignored at this point.

When the #include *filename* matches the pattern of *fname.suffix*, the search continues according to the subopts in the order specified. An asterisk (\*) in *fname*

or *suffix* matches anything. If the compiler does not find the file, it attempts other searches according to the remaining options in LSEARCH.

## Specifying z/OS UNIX System Services files

When specifying z/OS UNIX library searches, do not put double slashes at the beginning of the LSEARCH *opt*. Use *pathnames* separated by slashes (/) in the LSEARCH *opt* for a z/OS UNIX library. When the LSEARCH *opt* does not start with double slashes, any single slash in the name indicates a z/OS UNIX library. If you do not have path separators (/), then setting the OE compile option on indicates that this is a z/OS UNIX library; otherwise the library is interpreted as a data set. See “Using SEARCH and LSEARCH” on page 323 for additional information on z/OS UNIX files.

**Example:** The *opt* specified for LSEARCH is combined with the *filename* in #include to form the include file name:

```
LSEARCH(/u/mike/myfiles)
#include "new/headers.h"
```

The resulting z/OS UNIX file name is /u/mike/myfiles/new/headers.h.

## Specifying sequential data sets and PDSs

Use an asterisk (\*) or a plus sign (+) in the LSEARCH *opt* to specify whether the library is a sequential or partitioned data set.

**Partitioned Data Set (PDS):** When you want to specify a set of PDSs as the search path, you add a period followed by a plus sign (.+) at the end of the last qualifier in the *opt*. If you do not have any qualifier, specify a single plus sign (+) as the *opt*. The *opt* has the following syntax for specifying partitioned data set:

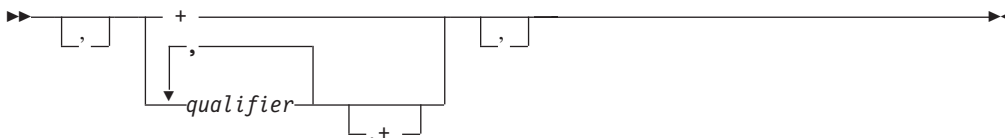

where *qualifier* is a data set qualifier.

Start and end the *opt* with single quotation marks (') to indicate that this is an absolute data set specification. Single quotation marks around a single plus sign (+) indicate that the *filename* that is specified in #include is an absolute partitioned data set.

When you do not specify a member name with the #include directive, for example, #include "PR1.MIKE.H", the PDS name for the search is formed by replacing the plus sign with the following parts of the *filename* of the #include directive:

- For the PDS file name:
  1. All the *paths* and slashes (slashes are replaced by periods)
  2. All the periods and *qualifiers* after the left-most *qualifier*
- For the PDS member name, the left-most *qualifier* is used as the member name

See the first example in Table 25 on page 157.



However, if you specified a member name in the *filename* of the #include directive, for example, #include "PR1.MIKE.H(M1)", the PDS name for the search is formed by replacing the plus sign with the qualified name of the PDS. See the second example in Table 25.

See "Forming data set names with LSEARCH | SEARCH options" on page 318 for more information on forming PDS names.

**Note:** To specify a single PDS as the *opt*, do not specify a trailing asterisk (\*) or plus sign (+). The library is then treated as a PDS but the PDS name is formed by just using the leftmost *qualifier* of the #include *filename* as the member name. For example:

```
LSEARCH(AAAA.BBBB)
#include "sys/ff.gg.hh"
```

Resulting PDS name is  
userid.AAAA.BBBB(FF)

Also see the third example in Table 25.

**Examples:** The following example shows you how to specify a PDS search path:

Table 25. Partitioned data set examples

| include Directive      | LSEARCH option  | Result           |
|------------------------|-----------------|------------------|
| #include "PR1.MIKE.H"  | LSEARCH('CC.+') | 'CC.MIKE.H(PR1)' |
| #include "PR.KE.H(M1)" | LSEARCH('CC.+') | 'CC.PR.KE.H(M1)' |
| #include "A.B"         | LSEARCH(CC)     | userid.CC(A)     |
| #include "A.B.D"       | LSEARCH(CC.+)   | userid.CC.B.D(A) |
| #include "a/b/dd.h"    | LSEARCH('CC.+') | 'CC.A.B.H(DD)'   |
| #include "a/dd.ee.h"   | LSEARCH('CC.+') | 'CC.A.EE.H(DD)'  |
| #include "a/b/dd.h"    | LSEARCH('+')    | 'A.B.H(DD)'      |
| #include "a/b/dd.h"    | LSEARCH(+)      | userid.A.B.H(DD) |
| #include "A.B(C)"      | LSEARCH('D.+')  | 'D.A.B(C)'       |

**Sequential data set:** When you want to specify a set of sequential data sets as the search path, you add a period followed by an asterisk (.\* ) at the end of the last qualifier in the *opt*. If you do not have any qualifiers, specify one asterisk (\*) as the *opt*. The *opt* has the following syntax for specifying a sequential data set:

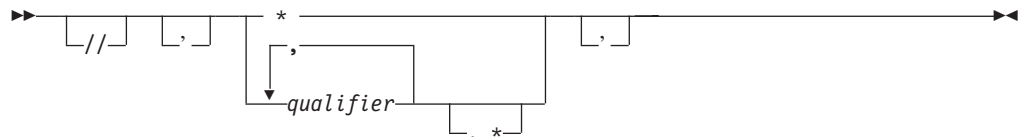

where *qualifier* is a data set qualifier.

Start and end the *opt* with single quotation marks (') to indicate that this is an absolute data set specification. Single quotation marks (') around a single asterisk (\*) means that the file name that is specified in #include is an absolute sequential data set.

The asterisk is replaced by all of the qualifiers and periods in the `#include filename` to form the complete name for the search (as shown in the following table).

**Examples:** The following example shows you how to specify a search path for a sequential data set:

Table 26. Sequential data set examples

| include Directive                | LSEARCH option               | Result                     |
|----------------------------------|------------------------------|----------------------------|
| <code>#include "A.B"</code>      | <code>LSEARCH(CC.*)</code>   | <code>userid.CC.A.B</code> |
| <code>#include "a/b/dd.h"</code> | <code>LSEARCH('CC.*')</code> | <code>'CC.DD.H'</code>     |
| <code>#include "a/b/dd.h"</code> | <code>LSEARCH('*')</code>    | <code>'DD.H'</code>        |
| <code>#include "a/b/dd.h"</code> | <code>LSEARCH(*)</code>      | <code>userid.DD.H</code>   |

**Note:** If the trailing asterisk is not used in the `LSEARCH opt`, then the specified library is a PDS:

```
#include "A.B"
LSEARCH('CC')
```

Result is 'CC(A)' which is a PDS.

## MARGINS | NOMARGINS

Default: For C++ and C (variable record format), the default option is `NOMARGINS`. For C (fixed record format), the default option is `MARGINS(1,72)`.

For the z/OS UNIX System Services utilities, the default for a regular compile is `NOMARGINS`.

| Option Scope |             |          |
|--------------|-------------|----------|
| C Compile    | C++ Compile | IPA Link |
| ✓            | ✓           | ✓        |

**Category:** Input Source File Processing Control

For C++ and C (variable record format):



For C (fixed record format):



The `MARGINS` option specifies the columns in the input record that are to be scanned for input to the compiler. The compiler ignores text in the source input that does not fall within the range that is specified on the `MARGINS` option.

You can use the `MARGINS` and `SEQUENCE` options together. The `MARGINS` option is applied first to determine which columns are to be scanned. The

SEQUENCE option is then applied to determine which of these columns are not to be scanned. If the SEQUENCE settings do not fall within the MARGINS settings, the SEQUENCE option has no effect.

When a source (or include) file is opened, it initially gets the margins and sequence specified on the command line (or the defaults if none was specified). You can reset these settings by using **#pragma margins** or **#pragma sequence** at any point in the file. When an `#include` file returns, the previous file keeps the settings it had when it encountered the `#include` directive.

The NOMARGINS option specifies that the entire input source record is to be scanned for input to the compiler.

The MARGINS option has the following suboptions:

- m* specifies the first column of the source input that contains valid z/OS XL C/C++ code. The value of *m* must be greater than 0 and less than 32761.
- n* specifies the last column of the source input that contains valid z/OS XL C/C++ code. The value of *n* must be greater than *m* and less than 32761. An asterisk (\*) can be assigned to *n* to indicate the last column of the input record. If you specify MARGINS (9,\*), the compiler scans from column 9 to the end of the record for input source statements.

If the MARGINS option is specified along with the SOURCE option in a C or C++ program, only the range specified on the MARGINS option is shown in the compiler source listing.

**Notes:**

1. The MARGINS option does not reformat listings.
2. If your program uses the `#include` preprocessor directive to include z/OS XL C library header files *and* you want to use the MARGINS option, you must ensure that the specifications on the MARGINS option does not exclude columns 20 through 50. That is, the value of *m* must be less than 20, and the value of *n* must be greater than 50. If your program does not include any z/OS XL C library header files, you can specify any setting you want on the MARGINS option when the setting is consistent with your own include files.

## MAXMEM | NOMAXMEM

Default: MAXMEM(\*)

For the z/OS UNIX System Services utilities, the default for a regular compile is MAXMEM(\*).

| Option Scope |             |          |
|--------------|-------------|----------|
| C Compile    | C++ Compile | IPA Link |
| ✓            | ✓           | ✓        |

**Category:** Object Code Control



When compiling with OPT, the MAXMEM(*size*) option limits the amount of memory used for local tables of specific, memory intensive optimizations to *size* kilobytes. The valid range for *size* is 0 to 2097152. You can use asterisk as a value for *size*, MAXMEM(\*), to indicate the highest possible value, which is also the default. NOMAXMEM, MAXMEM(0), and MAXMEM(\*) are equivalent. Use the MAXMEM option if you want to specify a memory size of less value than the default.

If the memory specified by the MAXMEM option is insufficient for a particular optimization, the compilation is completed in such a way that the quality of the optimization is reduced, and a warning message is issued.

When a large *size* is specified for MAXMEM, compilation may be aborted because of insufficient virtual storage, depending on the source file being compiled, the size of the subprogram in the source, and the virtual storage available for the compilation.

The advantage of using the MAXMEM option is that, for large and complex applications, the compiler produces a slightly less-optimized object module and generates a warning message, instead of terminating the compilation with an error message of “insufficient virtual storage”.

**Notes:**

1. The limit that is set by MAXMEM is the amount of memory for specific optimizations, and not for the compiler as a whole. Tables that are required during the entire compilation process are not affected by or included in this limit.
2. Setting a large limit has no negative effect on the compilation of source files when the compiler needs less memory.
3. Limiting the scope of optimization does not necessarily mean that the resulting program will be slower, only that the compiler may finish before finding all opportunities to increase performance.
4. Increasing the limit does not necessarily mean that the resulting program will be faster, only that the compiler may be able to find opportunities to increase performance.
5. At OPT(3), the default for MAXMEM is set to (\*).

You can specify this option using the **#pragma options** directive for C.

**Effect on IPA Compile step**

If you specify the MAXMEM option for any compilation unit in the IPA Compile step, the compiler generates information for the IPA Link step. This option also affects the regular object module if you request one by specifying the IPA(OBJECT) option.

The option value you specify on the IPA Compile step for each IPA object file appears in the IPA Link step Compiler Options Map listing section.

**Effect on IPA Link step**

If you specify the MAXMEM option on the IPA Link step, the value of the option is used. The IPA Link step Prolog and Partition Map listing sections display the value of the option.

If you do not specify the option on the IPA Link step, the value that it uses for a partition is the maximum MAXMEM value you specified for the IPA Compile step for any compilation unit that provided code for that partition. The IPA Link Step Prolog listing section does not display the value of the MAXMEM option, but the Partition Map listing section does.

## MEMORY | NOMEMORY

Default: MEMORY

| Option Scope |             |          |
|--------------|-------------|----------|
| C Compile    | C++ Compile | IPA Link |
| ✓            | ✓           | ✓        |

**Category:** File Management



The MEMORY option specifies that the compiler is to use a MEMORY file in place of a work-file if possible. See the *z/OS XL C/C++ Programming Guide* for more information on memory files.

This option generally increases compilation speed, but you may require additional memory to use it. If you use this option and the compilation fails because of a storage error, you must increase your storage size or recompile your program using the NOMEMORY option.

### Effect on IPA Link step

The MEMORY option has the same effect on the IPA Link step as it does on a regular compilation. If the IPA Link step fails due to an out-of-memory condition, provide additional virtual storage. If additional storage is unavailable, specify the NOMEMORY option.

## NAMEMANGLING

Default: NAMEMANGLING(zOSV1R2)

| Option Scope |             |          |
|--------------|-------------|----------|
| C Compile    | C++ Compile | IPA Link |
|              | ✓           | ✓        |

**Category:** Object Code Control

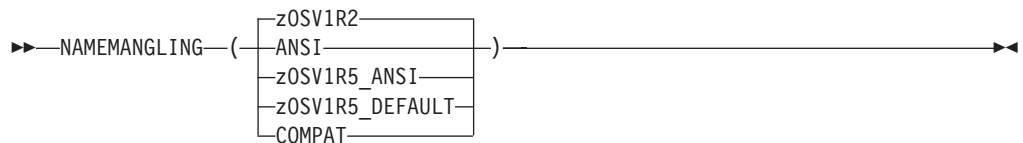

Name mangling is the encoding of variable names into unique names so that linkers can separate common names in the language. With respect to the C++ language, name mangling is commonly used to facilitate the overloading feature and visibility within different scopes. The NAMEMANGLING compiler option enables you to choose between the following two name mangling schemes:

**ANSI** This scheme complies with the C++ standard and is the default when the LP64 compiler option is specified.

#### zOSV1R5\_ANSI

This scheme is compatible with z/OS V1R5 link modules that were created with NAMEMANGLING(ANSI).

#### zOSV1R5\_DEFAULT

This scheme is equivalent to the zOSV1R2 scheme.

#### zOSV1R2

This scheme is compatible with z/OS V1R2 link modules that were created with NAMEMANGLING(ANSI). This name mangling scheme is the default when the ILP32 compiler option is specified.

#### COMPAT

This scheme is equivalent to the OSV2R10 scheme.

#### Notes:

1. If the NAMEMANGLING compiler option is not specified, LANGLVL(EXTENDED) and LANGLVL(ANSI) set NAMEMANGLING to zOSV1R2. LANGLVL(COMPAT92) sets NAMEMANGLING to COMPAT.
2. For information on the **#pragma namemangling** and **#pragma namemanglingrule** directives, see *z/OS XL C/C++ Language Reference*.

The NAMEMANGLING compiler option takes precedence over the LP64 compiler option. The LP64 compiler option takes precedence over the LANGLVL compiler option. When the NAMEMANGLING and LANGLVL compiler options are specified, the last specified option takes precedence. This is to preserve the V1R2 behavior so that existing code is not broken.

The following table shows some examples of the NAMEMANGLING options that are in effect when certain compiler options are specified:

Table 27. Examples of NAMEMANGLING in effect

| Compiler option(s) specified                    | NAMEMANGLING in effect |
|---|------------------------|
| NAMEMANGLING(zOSV1R2)                           | zOSV1R2                |
| LANGLVL(COMPAT92)                               | COMPAT                 |
| LP64  | ANSI                   |
| NAMEMANGLING(zOSV1R2)<br>LANGLVL(COMPAT92)      | COMPAT                 |
| LANGLVL(COMPAT92)<br>NAMEMANGLING(zOSV1R2)      | zOSV1R2                |
| NAMEMANGLING(zOSV1R2) LP64                      | zOSV1R2                |
| LP64 NAMEMANGLING(zOSV1R2)                      | zOSV1R2                |
| LANGLVL(COMPAT92) LP64                          | ANSI                   |
| LP64 LANGLVL(COMPAT92)                          | ANSI                   |
| NAMEMANGLING(zOSV1R2)<br>LANGLVL(COMPAT92) LP64 | COMPAT                 |
| NAMEMANGLING(zOSV1R2) LP64<br>LANGLVL(COMPAT92) | COMPAT                 |
| LP64 NAMEMANGLING(zOSV1R2)<br>LANGLVL(COMPAT92) | COMPAT                 |
| LP64 LANGLVL(COMPAT92)<br>NAMEMANGLING(zOSV1R2) | zOSV1R2                |

Table 27. Examples of NAMEMANGLING in effect (continued)

| Compiler option(s) specified                    | NAMEMANGLING in effect |
|---|------------------------|
| LANGLVL(COMPAT92) LP64<br>NAMEMANGLING(zOSV1R2) | zOSV1R2                |
| LANGLVL(COMPAT92)<br>NAMEMANGLING(zOSV1R2) LP64 | zOSV1R2                |

## NESTINC | NONESTINC

Default: NESTINC(255)

| Option Scope |             |          |
|--------------|-------------|----------|
| C Compile    | C++ Compile | IPA Link |
| ✓            | ✓           | ✓        |

**Category:** Input Source File Processing Control



The NESTINC option specifies the number of nested include files to be allowed in your source program. You can specify a limit of any integer from 0 to SHRT\_MAX, which indicates the maximum limit, as defined in the header file LIMITS.H. To specify the maximum limit, use an asterisk (\*). If you specify an invalid value, the compiler issues a warning message, and uses the default limit, which is 255.

Specifying NONESTINC is equivalent to specifying NESTINC(255).

**Note:** If you use heavily nested include files, your program requires more storage to compile.

## OBJECT | NOOBJECT

Default: OBJECT

**Note:** When you use the c89 utility, the object is assigned to //DD:SYSLIPA and should not be changed by specifying the OBJECT compiler option.

| Option Scope |             |          |
|--------------|-------------|----------|
| C Compile    | C++ Compile | IPA Link |
| ✓            | ✓           | ✓        |

**Category:** File Management and Object Code Control

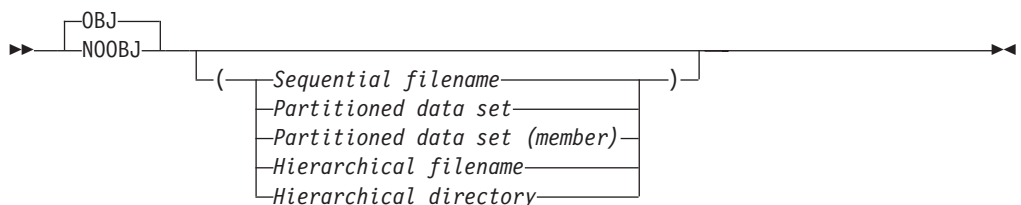

The OBJECT option specifies whether the compiler is to produce an object module.

The GOFF compiler option specifies the object format that will be used to encode the object information.

You can specify OBJECT(*filename*) to place the object module in that file. If you do not specify a file name for the OBJECT option, the compiler uses the SYSLIN ddname if you allocated it. Otherwise, the compiler generates a file name as follows:

- If you are compiling a data set, the compiler uses the source file name to form the name of the object module data set. The high-level qualifier is replaced with the userid under which the compiler is running, and .OBJ is appended as the low-level qualifier.
- If you are compiling a z/OS UNIX System Services file, the compiler stores the object module in a file that has the name of the source file with an .o extension.

The NOOBJ option can optionally take a *filename* suboption. This *filename* then becomes the default. If you subsequently use the OBJ option without a *filename* suboption, the compiler uses the *filename* that you specified in the earlier NOOBJ. For example, the following specifications have the same result:

```
CXX HELLO (NOOBJ(/hello.obj) OBJ
CXX HELLO (OBJ(/hello.obj)
```

If you specify OBJ and NOOBJ multiple times, the compiler uses the last specified option with the last specified suboption. For example, the following specifications have the same result:

```
CXX HELLO (NOOBJ(/hello.obj) OBJ(/n1.obj) NOOBJ(/test.obj) OBJ
CXX HELLO (OBJ(/test.obj)
```

If you request a listing by using the SOURCE, INLRPT, or LIST option, and you also specify OBJECT, the name of the object module is printed in the listing prolog.

You can specify this option using the **#pragma options** directive for C.

In the z/OS UNIX environment, you can specify the object location by using the **-c -o objectname** options when using the **c89**, **cc**, or **c++** commands.

**Note:** If you use the following form of the command in a JES3 batch environment where xxx is an unallocated data set, you may get undefined results.

```
OBJECT(xxx)
```

### Effect on IPA Compile step

IPA Compile uses the same rules as the regular compile to determine the file name or data set name of the object module it generates. If you specify NOOBJECT, the IPA Compile step suppresses object output, but performs all analysis and code generation processing (other than writing object records).

**Note:** You should not confuse the OBJECT compiler option with the IPA(OBJECT) suboption. The OBJECT option controls file destination. The IPA(OBJECT) suboption controls file content. Refer to “IPA | NOIPA” on page 124 for information about the IPA(OBJECT) suboption.

### Effect on IPA Link step

**c89** does not normally keep the object file output from the IPA Link step, as the output is an intermediate file in the link-edit phase processing. To find out how to



make the object file permanent, refer to the *prefix\_TMPS* environment variable information in the **c89** section of *z/OS UNIX System Services Command Reference*.

**Note:** The OBJECT compiler option is not the same as the OBJECT suboption of the IPA option. Refer to “IPA | NOIPA” on page 124 for information about the IPA(OBJECT) option.

## OBJECTMODEL

Default: OBJECTMODEL(COMPAT)

| Option Scope |             |          |
|--------------|-------------|----------|
| C Compile    | C++ Compile | IPA Link |
|              | ✓           | ✓        |

**Category:** Object Code Control



The OBJECTMODEL compiler option sets the type of object model.

z/OS XL C++ includes two ways to compile your programs using different object models. The two object models differ in the following areas:

- Layout for the virtual function table
- Name mangling scheme

The two object models are:

- COMPAT
- IBM

COMPAT is compatible with name mangling and the virtual function table that was available with the previous releases of the C++ compiler.

Select IBM if you want improved performance. This is especially true for class hierarchies with many virtual base classes. The size of the derived class is considerably smaller and access to the virtual function table is faster.

**Note:** In order to use the OBJECTMODEL(IBM) option, the XPLINK option must be specified. If XPLINK is not specified, the compiler will issue a warning and use the default OBJECTMODEL(COMPAT) setting.

### Effect on IPA Link step

The IPA Link step does not accept the OBJECTMODEL option. The compiler issues a warning message if you specify this option in the IPA Link step.

## OE | NOOE

Default: NOOE

When compiling in the z/OS UNIX System Services Shell environment, the default is OE.

| Option Scope |             |          |
|--------------|-------------|----------|
| C Compile    | C++ Compile | IPA Link |
| ✓            | ✓           | ✓        |

**Category:** File Management



**Note:** Diagnostics and listing information will refer to the file name that is specified for the OE option (in addition to the search information).

The OE option specifies that the compiler use the POSIX.2 standard rules when searching for files specified with `#include` directives. These rules state that the path of the file currently being processed is the path used as the starting point for searches of include files contained in that file.

The NOOE option can optionally take a *filename* suboption. This *filename* then becomes the default. If you subsequently use the OE option without a *filename* suboption, the compiler uses the *filename* that you specified in the earlier NOOE.

**Example:** The following specifications have the same result:

```
CXX HELLO (NOOE(/hello.c) OE
CXX HELLO (OE(/hello.c)
```

If you specify OE and NOOE multiple times, the compiler uses the last specified option with the last specified suboption.

**Example:** The following specifications have the same result:

```
CXX HELLO (NOOE(/hello.c) OE(/n1.c) NOOE(/test.c) OE
CXX HELLO (OE(/test.c)
```

When the OE option is in effect and the main input file is a z/OS UNIX file, the path of *filename* is used instead of the path of the main input file name. If the file names indicated in other options appear ambiguous between z/OS and the z/OS UNIX file system, the presence of the OE option tells the compiler to interpret the ambiguous names as z/OS UNIX file names. User include files that are specified in the main input file are searched starting from the path of *filename*. If the main input file is not a z/OS UNIX file, *filename* is ignored.

For example, if the compiler is invoked to compile a z/OS UNIX file `/a/b/hello.c` it searches directory `/a/b/` for include files specified in `/a/b/hello.c`, in accordance with POSIX.2 rules. If the compiler is invoked with the `OE(/c/d/hello.c)` option for the same source file, the directory specified as the suboption for the OE option, `/c/d/`, is used to locate include files specified in `/a/b/hello.c`.

### Effect on IPA Link step

On the IPA Link step, the OE option controls the display of file names.

## OFFSET | NOOFFSET

Default: NOOFFSET

In the z/OS UNIX System Services environment, this option is turned on by specifying `-V` when using the `c89`, `cc` or `c++` commands.

| Option Scope |             |          |
|--------------|-------------|----------|
| C Compile    | C++ Compile | IPA Link |
| ✓            | ✓           | ✓        |

**Category:** Listing

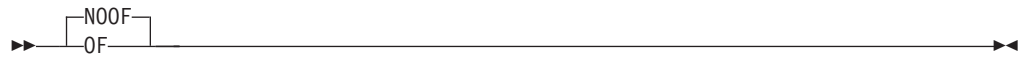

The `OFFSET` option instructs the compiler to display, in the pseudo-assembly listing generated by the `LIST` option, the offset addresses relative to the entry point or start of each function.

If you use the `OFFSET` option, you must also specify the `LIST` option to generate the pseudo-assembly listing. If you specify the `OFFSET` option but omit the `LIST` option, the compiler generates a warning message, and does not produce a pseudo-assembly listing.

The `NOOFFSET` option specifies that the compiler is to display, in the pseudo-assembly listing generated by the `LIST` option, the offset addresses relative to the beginning of the generated code and not the entry point.

### Effect on IPA Compile step

If you specify the `IPA(OBJECT)` option (that is, if you request code generation), the `OFFSET` option has the same effect on the IPA Compile step as it does on a regular compilation.

### Effect on IPA Link step

If you specify the `LIST` option during IPA Link, the IPA Link listing will be affected (in the same way as a regular compilation) by the `OFFSET` option setting in effect at that time.

The `OFFSET` option that you specified on the IPA Compile step has no effect on the IPA Link step.

## OPTFILE | NOOPTFILE

Default: `NOOPTFILE`

| Option Scope |             |          |
|--------------|-------------|----------|
| C Compile    | C++ Compile | IPA Link |
| ✓            | ✓           | ✓        |

**Category:** File Management



The OPTFILE option directs the compiler to look for compiler options in the file specified by *filename*.

You can specify any valid *filename*, including a DD name such as (DD:MYOPTS). The DD name may refer to instream data in your JCL. If you do not specify *filename*, the compiler uses DD:SYSOPTF.

The NOOPTF option can optionally take a *filename* suboption. This *filename* then becomes the default. If you subsequently use the OPTF option without a *filename* suboption, the compiler uses the *filename* that you specified in the earlier NOOPTF.

**Example:** The following specifications have the same result:

```
CXX HELLO (NOOPTF(/hello.opt) OPTF
CXX HELLO (OPTF(/hello.opt)
```

The options are specified in a free format with the same syntax as they would have on the command line or in JCL. The code points for the special characters \f, \v, and \t are whitespace characters. Everything that is specified in the file is taken to be part of a compiler option (except for the continuation character), and unrecognized entries are flagged. Nothing on a line is ignored.

If the record format of the options file is fixed and the record length is greater than 72, columns 73 to the end-of-line are treated as sequence numbers and are ignored.

#### Notes:

1. Comments are supported in an option file used in the OPTFILE option. When a line begins with the # character, the entire line is ignored, including any continuation character. The option files are encoded in the IBM-1047 codepage.
2. You cannot nest the OPTFILE option. If the OPTFILE option is also used in the file that is specified by another OPTFILE option, it is ignored.
3. If you specify NOOPTFILE after a valid OPTFILE, it does not undo the effect of the previous OPTFILE. This is because the compiler has already processed the options in the options file that you specified with OPTFILE. The only reason to use NOOPTFILE is to specify an option file name that a later specification of OPTFILE can use.
4. If the file cannot be opened or cannot be read, a warning message is issued and the OPTFILE option is ignored.
5. The options file can be an empty file.
6. **Example:** You can use an option file only once in a compilation. If you use the following options:

```
OPTFILE(DD:OF)    OPTFILE
```

the compiler processes the option OPTFILE(DD:OF), but the second option OPTFILE is not processed. A diagnostic message is produced, because the second specification of OPTFILE uses the same option file as the first.

**Example:** You can specify OPTFILE more than once in a compilation, if you use a different options file with each specification:

```
OPTFILE(DD:OF)    OPTFILE(DD:OF1)
```

#### Examples

1. Suppose that you use the following JCL:  

```
// CPARAM='SO OPTFILE(PROJ1OPT) EXPORTALL'
```

If the file PROJ10PT contains OBJECT LONGNAME, the effect on the compiler is the same as if you specified the following:

```
// CPARAM='SO OBJECT LONGNAME EXPORTALL'
```

- Suppose that you include the following in the JCL:

```
// CPARAM='OBJECT OPTFILE(PROJ10PT) LONGNAME OPTFILE(PROJ20PT) LIST'
```

If the file PROJ10PT contains SO LIST and the file PROJ20PT contains GONUM, the net effect to the compiler is the same as if you specified the following:

```
// CPARAM='OBJECT SO LIST LONGNAME GONUM LIST'
```

- If an F80 format options file looks like this:

```
| ...+...1...+...2...+...3...+...4...+...5...+...6...+...7...+...8
                                LIST                                00000010
                                INLRPT                             00000020
MARGINS                          00000030
  OPT                             00000040
  XREF                             00000050
```

The compile has the same effect as if you specified the following options on the command line or in a PARM= statement in your JCL:

```
LIST INLRPT MARGINS OPT XREF
```

- The following example shows how to use the options file as an instream file in JCL:

```
//COMP EXEC CBCC,
// INFILE='<userid>.USER.CXX(LNKLST)',
// OUTFILE='<userid>.USER.OBJ(LNKLST),DISP=SHR ',
// CPARAM='OPTFILE(DD:OPTION)'
//OPTION DD DATA,DLM=@@
                                LIST
                                INLRPT
MARGINS
  OPT
  XREF
@@
```

### Effect on IPA Link step

The OPTFILE option has the same effect on the IPA Link step as it does on a regular compilation.

## OPTIMIZE | NOOPTIMIZE

Default: For C and C++, the default option is NOOPTIMIZE. For IPA Link, the default option is OPTIMIZE(2).

For the z/OS UNIX System Services utilities, the default for a regular compile is OPTIMIZE(0) for NOIPA.

| Option Scope |             |          |
|--------------|-------------|----------|
| C Compile    | C++ Compile | IPA Link |
| ✓            | ✓           | ✓        |

**Category:** Object Code Control



**Note:** When the compiler is invoked using the **c89**, **cc**, **c++**, **xlc** or **xlC** commands under z/OS UNIX System Services, the optimization level is specified by the compiler flag **-O** (the letter O). The OPTIMIZE option has no effect on these commands.

The OPTIMIZE option instructs the compiler to optimize the generated machine instructions to produce a faster running object module. This type of optimization can also reduce the amount of main storage that is required for the generated object module. Using OPTIMIZE will increase compile time over NOOPTIMIZE and may have greater storage requirements. During optimization, the compiler may move code to increase run-time efficiency; as a result, statement numbers in the program listing may not correspond to the statement numbers used in run-time messages.

A list of the valid suboptions for OPT and their descriptions follow. *level* can have the following values:

- 0** Indicates that no optimization is to be done; this is equivalent to NOOPTIMIZE. You should use this option in the early stages of your application development since the compilation is efficient but the execution is not. This option also allows you to take full advantage of the debugger.
- 1** OPTIMIZE(1) is an obsolete artifact of the OS/390 Version 2 Release 4 compiler. We suggest that you use OPTIMIZE(2), which may help avoid compatibility issues.
- 2** Indicates that global optimizations are to be performed. You should be aware that the size of your functions, the complexity of your code, the coding style, and support of the ISO standard may affect the global optimization of your program. You may need significant additional memory to compile at this optimization level.
- 3** Performs additional optimizations to those performed with OPTIMIZE(2). OPTIMIZE(3) is recommended when the desire for run-time improvement outweighs the concern for minimizing compilation resources. Increasing the level of optimization may or may not result in additional performance improvements, depending on whether additional analysis detects further opportunities for optimization. Compilation may require more time and machine resources.

Use the STRICT option with OPTIMIZE(3) to turn off the aggressive optimizations that might change the semantics of a program. STRICT combined with OPTIMIZE(3) invokes all the optimizations performed at OPTIMIZE(2) as well as further loop optimizations. The STRICT compiler option must appear after the OPTIMIZE(3) option, otherwise it is ignored.

The aggressive optimizations performed when you specify OPTIMIZE(3) are:

- Aggressive code motion, and scheduling on computations that have the potential to raise an exception, are allowed.
- Conformance to IEEE rules are relaxed. With OPTIMIZE(2), certain optimizations are not performed because they may produce an incorrect sign in cases with a zero result, and because they remove an arithmetic operation that may cause some type of floating-point exception. For example,  $X + 0.0$  is not folded to  $X$  because, under IEEE rules,  $-0.0 + 0.0 = 0.0$ , which is  $-X$ . In some other cases, some optimizations may perform optimizations that yield a zero result with the wrong sign. For example,  $X - Y * Z$  may result in a  $-0.0$  where the original computation

would produce 0.0. In most cases, the difference in the results is not important to an application and OPTIMIZE(3) allows these optimizations.

- Floating-point expressions may be rewritten. Computations such as  $a*b*c$  may be rewritten as  $a*c*b$  if, for example, an opportunity exists to get a common subexpressions by such rearrangement. Replacing a divide with a multiply by the reciprocal is another example of reassociating floating-point computations.

#### **no level**

OPTIMIZE specified with no level defaults, depending on the compilation environment and IPA mode. See the Option Default table above for details.

You can specify this option using the **#pragma options** directive for C.

You can specify this option for a specific subprogram using the **#pragma option\_override(subprogram\_name, "OPT(LEVEL,n)")** directive.

The OPTIMIZE option will control the overall optimization value. Any subprogram-specific optimization levels specified at compile time by **#pragma option\_override(subprogram\_name, "OPT(LEVEL,n)")** directives will be retained. Subprograms with an OPT(LEVEL,0) value will receive minimal code generation optimization. Subprograms may not be inlined or inline other subprograms. Generate and check the inline report to determine the final status of inlining.

Inlining of functions in conjunction with other optimizations provides optimal run-time performance. See "INLINE | NOINLINE" on page 119 for more information about the INLINE option and the optimization information in *z/OS XL C/C++ Programming Guide*.

If you specify OPTIMIZE with TEST or DEBUG, you can only set breakpoints at function call, function entry, function exit, and function return points.

The option INLINE is automatically turned on when you specify OPTIMIZE, unless you have explicitly specified the NOINLINE option.

A comment that notes the level of optimization will be generated in your object module to aid you in diagnosing your program.

**Effect of ANSIALIAS:** When the ANSIALIAS option is specified, the optimizer assumes that pointers can point only to objects of the same type, and performs more aggressive optimization. However, if this assumption is not true and ANSIALIAS is specified, wrong program code could be generated. If you are not sure, use NOANSIALIAS. For more information, see "ANSIALIAS | NOANSIALIAS" on page 69.

#### **Effect on IPA(OBJONLY) compilation**

During a compilation with IPA Compile-time optimizations active, any subprogram-specific optimization levels specified by **#pragma option\_override(subprogram\_name, "OPT(LEVEL,n)")** directives will be retained. Subprograms with an OPT(LEVEL,0) value will receive minimal IPA and code generation optimization. Subprograms may not be inlined or inline other subprograms. Generate and check the inline report to determine the final status of inlining.

## Effect on IPA Compile step

On the IPA Compile step, all values (except for (0)) of the OPTIMIZE compiler option and the OPT suboption of the IPA option have an equivalent effect.

Refer to the descriptions of the OPTIMIZE and LEVEL suboptions of the IPA option in “IPA | NOIPA” on page 124 for information about using the OPTIMIZE option under IPA.

## Effect on IPA Link step

OPTIMIZE(2) is the default for the IPA Link step, but you can specify any level of optimization. The IPA Link step Prolog listing section will display the value of this option.

This optimization level will control the overall optimization value. Any subprogram-specific optimization levels specified at IPA Compile time by **#pragma option\_override(subprogram\_name, "OPT(LEVEL,n)")** directives will be retained. Subprograms with an OPT(LEVEL,0) value will receive minimal IPA and code generation optimization, and will not participate in IPA Inlining.

The IPA Link step merges and optimizes your application code, and then divides it into sections for code generation. Each of these sections is a partition. The IPA Link step uses information from the IPA Compile step to determine if a subprogram can be placed in a particular partition. Only compatible subprograms are included in a given partition. Compatible subprograms have the same OPTIMIZE setting.

The OPTIMIZE setting for a partition is set to that of the first subprogram that is placed in the partition. Subprograms that follow are placed in partitions that have the same OPTIMIZE setting. An OPTIMIZE(0) mode is placed in an OPTIMIZE(0) partition, and an OPTIMIZE(2) is placed in an OPTIMIZE(2) partition.

The option value that you specified for each IPA object file on the IPA Compile step appears in the IPA Link step Compiler Options Map listing section.

The Partition Map sections of the IPA Link step listing and the object module END information section display the value of the OPTIMIZE option. The Partition Map also displays any subprogram-specific OPTIMIZE values.

If you specify OPTIMIZE(2) for the IPA Link step, but only OPTIMIZE(0) for the IPA Compile step, your program may be slower or larger than if you specified OPTIMIZE(2) for the IPA Compile step. This situation occurs because the IPA Compile step does not perform as many optimizations if you specify OPTIMIZE(0).

Refer to the descriptions for the OPTIMIZE and LEVEL suboptions of the IPA option in “IPA | NOIPA” on page 124 for information about using the OPTIMIZE option under IPA.

## PHASEID | NOPHASEID

Default: NOPHASEID

| Option Scope |             |          |
|--------------|-------------|----------|
| C Compile    | C++ Compile | IPA Link |
| ✓            | ✓           | ✓        |

**Category:** Debug/Diagnostic





If you specify the NOPHASEID option, it causes each compiler component (phase) to issue an informational message as the phase begins execution. This message identifies compiler phase module name, product identification, and build level. Use the PHASEID option to assist you with determining the maintenance level of each compiler component (phase).

The compiler issues a separate CCN0000(I) message each time compiler execution causes a given compiler component (phase) to be entered. This could happen many times for a given compilation.

The FLAG option has no effect on the PHASEID informational message.

## PLIST

Default: PLIST(HOST)

| Option Scope |             |          |
|--------------|-------------|----------|
| C Compile    | C++ Compile | IPA Link |
| ✓            | ✓           | ✓        |

**Category:** Program Execution



When compiling `main()` programs, use the PLIST option to direct how the parameters from the caller are passed to `main()`.

If you specify PLIST(HOST), the parameters are presented to `main()` as an argument list (`argc`, `argv`).

If you specify PLIST(OS), the parameters are passed without restructuring, and the standard calling conventions of the operating system are used. See *z/OS Language Environment Programming Guide* for details on how to access these parameters.

If you are compiling a `main()` program to run under IMS, you must specify the PLIST(OS) and TARGET(IMS) options together.

### Effect on IPA Compile step

If you specified PLIST for any compilation unit in the IPA Compile step, it generates information for the IPA Link step. This option also affects the regular object module if you request one by specifying the IPA(OBJECT) option.

### Effect on IPA Link step

If you specify PLIST for the IPA Compile step, you do not need to specify it again on the IPA Link step. The IPA Link step uses the information generated for the compilation unit that contains the `main()` function, or for the first compilation unit it finds if it cannot find a compilation unit containing `main()`.

If you specify this option on both the IPA Compile and the IPA Link steps, the setting on the IPA Link step overrides the setting on the IPA Compile step. This situation occurs whether you use PLIST as a compiler option or specify it using the **#pragma runopts** directive (on the IPA Compile step).

## PORT | NOPORT

Default: NOPORT(NOPPS)

| Option Scope |             |          |
|--------------|-------------|----------|
| C Compile    | C++ Compile | IPA Link |
|              | ✓           |          |

**Category:** Portability



The PORT option allows you to adjust the error recovery action that the compiler takes when it encounters an ill-formed **#pragma pack** directive. When you specify PORT(PPS), the compiler uses the strict error recovery mode. When you specify any other value for either PORT or NOPORT, the compiler uses the default error recovery mode. When you specify PORT without a suboption, the suboption setting is inherited from the default setting or from previous PORT specifications.

### Default error recovery

When the default error recovery mode is active, the compiler recovers from errors in the **#pragma pack** directive as follows:

- **#pragma pack** (*first\_value*)
  - If *first\_value* is a valid suboption for **#pragma pack**, packing is done as specified by *first\_value*. The compiler detects the missing closing parentheses and issues a warning message.
  - If *first\_value* is not a valid suboption for **#pragma pack**, no packing changes are made. The compiler ignores the **#pragma pack** directive and issues a warning message.
- **#pragma pack** (*first\_value bad\_tokens*)
  - If *first\_value* is a valid suboption for **#pragma pack**, packing is done as specified by *first\_value*. If *bad\_tokens* is invalid, the compiler detects it and issues a warning message.
  - If *first\_value* is not a valid suboption for **#pragma pack**, no packing changes will be performed. The compiler will ignore the **#pragma pack** directive and issue a warning message.
- **#pragma pack** (*valid\_value*) *extra\_trailing\_tokens*
  - The compiler ignores the extra text and issues an information message.

### Strict error recovery

To use the strict error recovery mode of the compiler, you must explicitly request it by specifying PORT(PPS).

When the strict error recovery mode is active, and the compiler detects errors in the **#pragma pack** directive, it ignores the pragma and does not make any packing changes.

**Example:** For example, the compiler detects errors for any of the following specifications of the **#pragma pack** directive:

```
#pragma pack(first_value)
#pragma pack(first_value bad_tokens)
#pragma pack(valid_value) extra_trailing_tokens
```

See *z/OS XL C/C++ Language Reference* for more information on **#pragma pack**.

### Effect on IPA Link step

The IPA Link step issues a diagnostic message if you specify the PORT option for that step.

## PPONLY | NOPPONLY

Default: NOPPONLY

For the z/OS UNIX System Services utilities, the default for a regular compile is NOPPONLY(NOCOMMENTS, NOLINES, /dev/fd1, 2048).

In the z/OS UNIX System Services environment, this option is turned on by specifying the -E flag option when using the c89 utility to invoke the compiler. When using the xlc utility, this option can be turned on by specifying the -E or -P flag options, or by specifying the **-qpponly** compiler option in a manner similar to specifying the PPOONLY option in JCL or TSO compiler invocations.

| Option Scope |             |          |
|--------------|-------------|----------|
| C Compile    | C++ Compile | IPA Link |
| ↙            | ↙           | ↙        |

**Category:** Preprocessor

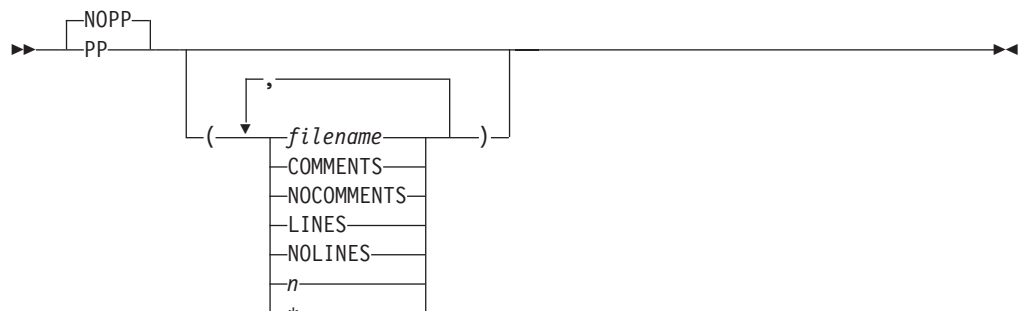

PPOONLY output is typically requested when reporting a compiler problem to IBM using a Problem Management Record (PMR), so your build process should be able to produce a PPOONLY file on request.

**Note:** For further information on the PMR process, refer to [techsupport.services.ibm.com/guides/handbook.html](http://techsupport.services.ibm.com/guides/handbook.html).

The PPONLY option specifies that only the preprocessor is to be run against the source file. This output of the preprocessor consists of the original source file with all the macros expanded and all the include files inserted. It is in a format that can be compiled. PPONLY also removes conditional compilation constructs like #if, and #ifdef.

The suboptions are:

COMMENTS | NOCOMMENTS

The COMMENTS suboption preserves comments in the preprocessed output. The default is NOCOMMENTS.

LINES | NOLINES

The LINES suboption issues #line directives at include file boundaries, block boundaries and where there are more than 3 blank lines. The default is NOLINES.

*filename*

The name for the preprocessed output file. The *filename* may be a data set or a z/OS UNIX file. If you do not specify a file name for the PPONLY option, the SYSUT10 ddname is used if it has been allocated. If SYSUT10 has not been allocated, the file name is generated as follows:

- If a data set is being compiled, the name of the preprocessed output data set is formed using the source file name. The high-level qualifier is replaced with the userid under which the compiler is running, and .EXPAND is appended as the low-level qualifier.
- If the source file is a z/OS UNIX file, the preprocessed output is written to a z/OS UNIX file that has the source file name with .i extension.

**Note:** If you are using the xlc utility and you do not specify the file name, the preprocessed output goes to stdout. If -E or -P is also specified, the output file is determined by the -E option. The -E flag option maps to PP(stdout). -P maps to PP(default\_name). default\_name is constructed using the source file name as the base and the suffix is replaced with the appropriate suffix, as defined by the isuffix, isuffix\_host, ixsuffix, and ixsuffix\_host configuration file attributes. See Chapter 21, “xlc — Compiler invocation using a customizable configuration file,” on page 527 for further information on the xlc utility.

*n*

If a parameter *n*, which is an integer between 2 and 32752 inclusive, is specified, all lines are folded at column *n*. The default for *n* is 72.

**Note:** If the PPONLY output is directed into an existing file, and *n* is larger than the maximum record length of the file, then all

lines are folded to fit into the output file,  
based on the record length of the output file.

\* If an asterisk (\*) is specified, the lines are folded at the maximum record length of 32752. Otherwise, all lines are folded to fit into the output file, based on the record length of the output file.

**Notes:**

1. If the PPOONLY output is directed into an existing file, the record length of the file will be used to override the value of *n* if that value is bigger than the maximum record length.

The PPOONLY suboptions are cumulative. If you specify suboptions in multiple instances of PPOONLY and NOPPOONLY, all the suboptions are combined and used for the last occurrence of the option.

**Example:** The following three specifications have the same result:

```
CXX HELLO (NOPPOONLY(/aa.exp) PPOONLY(LINES) PPOONLY(NOLINES)
CXX HELLO (PPOONLY(/aa.exp,LINES,NOLINES)
CXX HELLO (PPOONLY(/aa.exp,NOLINES)
```

All `#line` and `#pragma` preprocessor directives (except for margins and sequence directives) remain. When you specify PPOONLY(\*), `#line` directives are generated to keep the line numbers generated for the output file from the preprocessor similar to the line numbers generated for the source file. All consecutive blank lines are suppressed.

If you specify the PPOONLY option, the compiler turns on the TERMINAL option. If you specify the SHOWINC, XREF, AGGREGATE, or EXPMAC options with the PPOONLY option, the compiler issues a warning, and ignores the options.

If you specify the PPOONLY and LOCALE options, all the `#pragma filetag` directives in the source file are suppressed. The compiler generates its `#pragma filetag` directive at the first line in the preprocessed output file in the following format:

```
??=pragma filetag ("locale code page")
```

In the above, `??=` is a trigraph representation of the `#` character.

The code page in the pragma is the code set that is specified in the LOCALE option. For more information on locales, refer to *z/OS XL C/C++ Programming Guide*.

The NOPPOONLY option specifies that both the preprocessor and the compiler are to be run against the source file.

If you specify both PPOONLY and NOPPOONLY, the last one that is specified is used.

In the z/OS UNIX environment, the COMMENTS suboption can be requested by specifying the `-C` flag option. When using the `c89` utility to invoke the compiler, the PPOONLY compiler option cannot be specified. A combination of `-E` and `-C` flag options must be used instead. The `c89` utility also provides the `prefix_ELINES` environment variable to control the LINES suboption (for further information on `prefix_ELINES`, refer to “Environment variables” on page 504). The output always goes to `stdout` when using the `c89` utility because the PPOONLY option can only be turned on by specifying the `-E` flag option. These limitations do not exist when using

the xlc utility because the PPOONLY option can be specified in addition to the -E, -P and -C flag options (for example, -qpponly=foo.pp:comments:nolines:65).

**Note:** -Wc,PPOONLY syntax is not supported.

## REDIR | NOREDIR

**Default:** REDIR

| Option Scope |             |          |
|--------------|-------------|----------|
| C Compile    | C++ Compile | IPA Link |
| ✓            | ✓           | ✓        |

**Category:** Program Execution



The REDIR option directs the compiler to create an object module that, when linked and run, allows you to redirect stdin, stdout, and stderr for your program from the command line when invoked from TSO or batch. REDIR does not apply to programs invoked by the exec or spawn family of functions (in other words, redirection does not apply to programs invoked from the z/OS UNIX System Services shell).

### Effect on IPA Compile step

If you specify the REDIR option for any compilation unit in the IPA Compile step, the compiler generates information for the IPA Link step. This option also affects the regular object module if you request one by specifying the IPA(OBJECT) option.

### Effect on IPA Link step

If you specify the REDIR option for the IPA Compile step, you do not need to specify it again on the IPA Link step. The IPA Link step uses the information generated for the compilation unit that contains the main() function, or for the first compilation unit it finds if it cannot find a compilation unit containing main().

If you specify this option on both the IPA Compile and the IPA Link steps, the setting on the IPA Link step overrides the setting on the IPA Compile step. This situation occurs whether you use REDIR and NOREDIR as compiler options or specify them using the #pragma runopts directive (on the IPA Compile step).

## RENT | NORENT

**Default:** NORENT for C and RENT for C++

For the z/OS UNIX System Services utilities, the default for a regular compile is RENT.

| Option Scope |             |          |
|--------------|-------------|----------|
| C Compile    | C++ Compile | IPA Link |
| ✓            |             | ✓        |

**Category:** Object Code Control

For C:



The RENT option specifies that the compiler is to take code that is not naturally reentrant and make it reentrant. Refer to *z/OS Language Environment Programming Guide* for a detailed description of reentrancy.

If you use the RENT option, the linkage editor cannot directly process the object module that is produced. You must use either the binder, which is described in Chapter 9, “Binding z/OS XL C/C++ programs,” on page 355, or the prelinker, which is described in Appendix A, “Prelinking and linking z/OS XL C/C++ programs,” on page 549.

#### Notes:

1. Whenever you specify the RENT compiler option, a comment that indicates its use is generated in your object module to aid you in diagnosing your program.
2. z/OS XL C++ code always uses constructed reentrancy so the RENT option is always in effect for C++. For C++, you cannot specify NORENT.
3. RENT variables reside in the modifiable writable static area for both z/OS XL C and z/OS XL C++ programs.
4. NORENT variables reside in the code area (which may be write protected) for z/OS XL C programs.

The NORENT option specifies that the compiler is not to specifically generate reentrant code from non-reentrant code. Any naturally reentrant code remains reentrant.

You can specify this option using the **#pragma options** directive for C.

**Note:** The RENT compiler option has implications on how the binder processes objects. See *z/OS MVS Program Management: User's Guide and Reference* for further information.

#### Effect on IPA Compile step

If you specify RENT or use **#pragma strings(readonly)** or **#pragma variable(RENTINORENT)** during the IPA Compile step, the information in the IPA object file reflects the state of each symbol.

#### Effect on IPA Link step

If you specify the RENT option on the IPA Link step, it ignores the option. The reentrant/nonreentrant state of each symbol is maintained during IPA optimization and code generation. If any symbols within a partition are reentrant, the option section of the Partition Map displays the RENT compiler option.

If you generate an IPA Link listing by using the LIST or MAP compiler option, the IPA Link step generates a Partition Map listing section for each partition. If any symbols within a partition are reentrant, the options section of the Partition Map displays the RENT compiler option.

## ROCONST | NOROCONST

**Default:** For C, the default option is NOROCONST. For C++, the default option is ROCONST.

| Option Scope |             |          |
|--------------|-------------|----------|
| C Compile    | C++ Compile | IPA Link |
| ✓            | ✓           | ✓        |

**Category:** Object Code Control

For C:

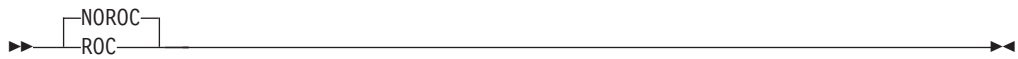

For C++:



The ROCONST option informs the compiler that the `const` qualifier is respected by the program. Variables defined with the `const` keyword will not be overridden by a casting operation.

When the ROCONST option is specified, `const` qualified variables are not placed into the Writeable Static Area (WSA), even if the RENT option is in effect. This reduces the memory requirement for DLLs. This option has the same effect for all `const` variables as the **#pragma variable**(*var\_name*, NORENT) directive. See *z/OS XL C/C++ Language Reference* for more information on **#pragma variable**.

Note that such `const` variables cannot be exported.

### Interaction with #pragma variable

If the specification for a `const` variable in a **#pragma variable** directive is in conflict with the option, the **#pragma variable** takes precedence. The compiler issues an informational message.

### Interaction with #pragma export

If you set the ROCONST option, and if there is a **#pragma export** for a `const` variable, the pragma directive takes precedence. The compiler issues an informational message. The variable will still be exported and the variable will be reentrant.

### Effect on IPA Compile step

If you specify the ROCONST option during the IPA Compile step, the information in the IPA object file reflects the state of each symbol.

### Effect on IPA Link step

If you specify the ROCONST option on the IPA Link step, it ignores the option. The reentrant or non-reentrant and `const` or non-`const` state of each symbol is maintained during IPA optimization and code generation.

The IPA Link step merges and optimizes your application code, and then divides it into sections for code generation. Each of these sections is a partition. The IPA Link step uses information from the IPA Compile step to determine if a subprogram can



be placed in a particular partition. Only compatible subprograms are included in a given partition. Compatible subprograms have the same ROCONST setting.

The ROCONST setting for a partition is set to the specification of the first subprogram that is placed in the partition.

The option value that you specified for each IPA object file on the IPA Compile step appears in the IPA Link step Compiler Options Map listing section.

The RENT, ROCONST, and ROSTRING options all contribute to the re-entrant or non-reentrant state for each symbol.

The Partition Map sections of the IPA Link step listing and the object module END information section display the value of the ROCONST option.

## ROSTRING | NOROSTRING

**Default:** ROSTRING

| Option Scope |             |          |
|--------------|-------------|----------|
| C Compile    | C++ Compile | IPA Link |
| ✓            | ✓           | ✓        |

**Category:** Object Code Control



The ROSTRING option informs the compiler that string literals are read-only. This option has the same effect as the **#pragma strings(readonly)** directive. See *z/OS XL C/C++ Language Reference* for more information on **#pragma strings**.

Specifying the ROSTRING option allows the compiler to place string literals into read-only memory. When you compile the program with the RENT option, such string literals are not placed into the Writeable Static Area (WSA). This reduces the memory requirement for DLLs.

### Effect on IPA Compile step

If you specify the ROSTRING option during the IPA Compile step, the information in the IPA object file reflects the state of each symbol.

### Effect on IPA Link step

If you specify the ROSTRING option on the IPA Link step, it ignores the option. The reentrant or nonreentrant state of each symbol is maintained during IPA optimization and code generation.

The Partition Map section of the IPA Link step listing and the object module do not display information about the ROSTRING option for that partition. The RENT, ROCONST, and ROSTRING options all contribute to the reentrant or nonreentrant state for each symbol. If any symbols within a partition are reentrant, the option section of the Partition Map displays the RENT compiler option.

# ROUND

**Default:** For FLOAT(IEEE), the default option is ROUND(N). For FLOAT(HEX), the default option is ROUND(Z).

| Option Scope |             |          |
|--------------|-------------|----------|
| C Compile    | C++ Compile | IPA Link |
| ✓            | ✓           | ✓        |

**Category:** Object Code Control

For FLOAT(IEEE):



For FLOAT(HEX):



The ROUND(*mode*) option sets the rounding mode for floating-point compilations at compile time where *mode* can be one of the following:

- N            round to the nearest representable number
- M            round towards minus infinity
- P            round towards plus infinity
- Z            round towards zero
- ROUND()    is the same as ROUND(N)

The ROUND(*mode*) option only applies to IEEE floating-point mode. In hexadecimal mode, the rounding is always towards zero. If you specify ROUND(*mode*) in hexadecimal floating-point mode, where *mode* is not Z, the compiler ignores ROUND(*mode*) and issues a warning.

## Effect on IPA Compile step

The IPA Compile step generates information for the IPA Link step. The ROUND option also affects the regular object module if you request one by specifying the IPA(OBJECT) option.

## Effect on IPA Link step

The IPA Link step merges and optimizes the application code, and then divides it into sections for code generation. Each of these section is a partition. The IPA Link step uses information from the IPA Compile step to ensure that an object is included in a compatible partition. Refer to the "FLOAT" on page 106 for further information.

## RTTI | NORTTI

**Default:** NORTTI

| Option Scope |             |          |
|--------------|-------------|----------|
| C Compile    | C++ Compile | IPA Link |
|              | ✓           | ✓        |

**Category:** Program Execution

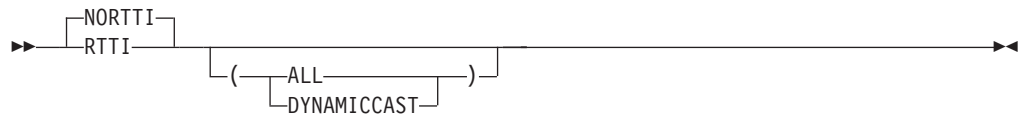

Use the RTTI option to generate run-time type identification (RTTI) information for the typeid operator and the dynamic\_cast operator. For best run-time performance, suppress RTTI information generation with the default NORTTI setting.

The C++ language offers a (RTTI) mechanism for determining the class of an object at run time. It consists of two operators:

- One for determining the run-time type of an object (typeid), and
- One for doing type conversions that are checked at run time (dynamic\_cast)

The suboptions are:

|             |  |
|-------------|--|
| ALL         | The compiler generates the information needed for the RTTI typeid and dynamic_cast operators. If you specify just RTTI, this is the default suboption. |
| DYNAMICCAST | The compiler generates the information needed for the RTTI dynamic_cast operator, but the information needed for typeid operator is not generated.     |

**Note:** Even though the default is NORTTI, if you specify LANGLVL(EXTENDED) you will also implicitly select RTTI.

### Effect on IPA Link step

The IPA Link step does not accept the RTTI option. The compiler issues a warning message if you specify this option in the IPA Link step.

## SEARCH | NOSEARCH

**Default:** For C++, the default option is SE(//CEE.SCEEH.+ , //CBC.SCLBH.+'). For C, the default option is SE(//CEE.SCEEH.+').

**Note:** The c99, c89, cc, and c++ utilities explicitly specify this option in the z/OS UNIX System Services shell. The suboptions are determined by the following:

- Additional include search directories identified by the **c89 -I** options. Refer to Chapter 20, “c89 — Compiler invocation using host environment variables,” on page 489 for more information.
- z/OS UNIX System Services environment variable settings: *prefix\_INCDIRS*, *prefix\_INCLIBS*, and *prefix\_CSYSLIB*. They are normally

set during compiler installation to reflect the compiler and run-time include libraries. Refer to “Environment variables” on page 504 for more information.

This option is specified as NOSEARCH, SEARCH by the c89 utility, so it resets the SEARCH parameters you specify. While the c89 utility forces NOSEARCH so that any defaults that are set by the customizable defaults module CCNEDFLT are cleared, the xlc utility relies on the entry in the configuration file for that purpose. If you do not specify **-qnosearch** in the configuration file, **xlc** will append the search libraries specified via the -I flags to the libraries set by the CCNEDFLT customizable defaults module. This essentially allows xlc users to take advantage of the customization module, which is not the case with the c89 utility.

| Option Scope |             |          |
|--------------|-------------|----------|
| C Compile    | C++ Compile | IPA Link |
| ✓            | ✓           | ✓        |

**Category:** File Management



The SEARCH option directs the preprocessor to look for system include files in the specified libraries. System include files are those files that are associated with the #include <filename> form of the #include preprocessor directive. See “Using include files” on page 316 for a description of the #include preprocessor directive.

For further information on library search sequences, see “Search sequences for include files” on page 325.

The suboptions for the SEARCH option are identical to those for the LSEARCH option, as described on page “LSEARCH | NOSEARCH” on page 153.

The SYSLIB ddname is considered the last suboption for SEARCH, so that specifying SEARCH (X) is equivalent to specifying SEARCH(X,DD:SYSLIB).

Any NOSEARCH option cancels all previous SEARCH specifications, and any SEARCH options that follow it are used. When more than one SEARCH compile option is specified, all libraries in the SEARCH options are used to find the system include files.

The NOSEARCH option instructs the preprocessor to search only those libraries that are specified on the SYSLIB statement.

**Notes:**

1. SEARCH allows the compiler to distinguish between header files that have the same name but reside in different data sets. If NOSEARCH is in effect, the compiler searches for header files only in the data sets concatenated under the SYSLIB DD statement. As the compiler includes the header files, it uses the first

file it finds, which may not be the correct one. Thus the build may encounter unpredictable errors in the subsequent link-edit or bind, or may result in a malfunctioning application.

2. If the *filename* in the `#include` directive is in absolute form, searching is not performed. See “Determining whether the file name is in absolute form” on page 321 for more details on absolute `#include filename`.

### Effect on IPA Compile step

The SEARCH option is used for source code searching, and has the same effect on an IPA Compile step as it does on a regular compilation.

### Effect on IPA Link step

The IPA Link step accepts the SEARCH option, but ignores it.

## SEQUENCE | NOSEQUENCE

**Default:** For C++ and C (variable record format and the z/OS UNIX System Services file system), the default option is NOSEQUENCE. For C (fixed record format), the default option is SEQUENCE(73,80).

For the z/OS UNIX System Services utilities, the default for a regular compile is NOSEQUENCE.

| Option Scope |             |          |
|--------------|-------------|----------|
| C Compile    | C++ Compile | IPA Link |
| ✓            | ✓           | ✓        |

**Category:** Input Source File Processing Control

For C and C++ (variable record format and the z/OS UNIX file system):



For C (fixed record format):



The SEQUENCE option defines the section of the input record that is to contain sequence numbers. No attempt is made to sort the input lines or records into the specified sequence or to report records out of sequence.

You can use the MARGINS and SEQUENCE options together. The MARGINS option is applied first to determine which columns are to be scanned. The SEQUENCE option is then applied to determine which of these columns are not to be scanned. If the SEQUENCE settings do not fall within the MARGINS settings, the SEQUENCE option has no effect.

The SEQUENCE option has the following suboptions:

- m* Specifies the column number of the left-hand margin. The value of *m* must be greater than 0 and less than 32767.

*n* Specifies the column number of the right-hand margin. The value of *n* must be greater than *m* and less than 32767. An asterisk (\*) can be assigned to *n* to indicate the last column of the input record. Thus, SEQUENCE (74,\*) shows that sequence numbers are between column 74 and the end of the input record.

**Note:** If your program uses the #include preprocessor directive to include z/OS XL C library header files and you want to use the SEQUENCE option, you must ensure that the specifications on the SEQUENCE option do not include any columns from 20 through 50. That is, both *m* and *n* must be less than 20, or both must be greater than 50. If your program does not include any z/OS XL C/C++ library header files, you can specify any setting you want on the SEQUENCE option when the setting is consistent with your own include files.

## SERVICE | NOSERVICE

**Default:** NOSERVICE

| Option Scope |             |          |
|--------------|-------------|----------|
| C Compile    | C++ Compile | IPA Link |
| ✓            | ✓           | ✓        |

**Category:** Debug/Diagnostic



The SERVICE option places a string in the object module. The string is loaded into memory when the program is executing. If the application fails abnormally, the string is displayed in the traceback.

For z/OS XL C, you can also specify this option in the source file by using the **#pragma options** directive. If the SERVICE option is specified both on a **#pragma options** directive and on the command line, the option that is specified on the command line will be used.

You must enclose your string within opening and closing parentheses. You do not need to include the string in quotes.

The following restrictions apply to the string specified:

- The string cannot exceed 64 characters in length. If it does, excess characters are removed, and the string is truncated to 64 characters. Leading and trailing blanks are also truncated.

**Note:** Leading and trailing spaces are removed first and then the excess characters are truncated.

- All quotes that are specified in the string are removed.
- All characters, including DBCS characters, are valid as part of the string provided they are within the opening and closing parentheses.
- Parentheses that are specified as part of the string must be balanced. That is, for each opening parentheses, there must be a closing one. The parentheses must match after truncation.

- When using the **#pragma options** directive (C only), the text is converted according to the locale in effect.
- Only characters which belong to the invariant character set should be used, to ensure that the signature within the object module remains readable across locales.

You can specify this option using the **#pragma options** directive for C.

### Effect on IPA Link step

If you specify the **SERVICE** option on the IPA Compile step, or specify **#pragma options(SERVICE)** in your code, it has no effect on the IPA Link step. Only the **SERVICE** option you specify on the IPA Link step affects the generation of the service string for that step.

## SHOWINC | NOSHOWINC

**Default:** NOSHOWINC

In the z/OS UNIX System Services environment, this option is turned on by specifying **-V** when using the **c89**, **cc** or **c++** commands.

| Option Scope |             |          |
|--------------|-------------|----------|
| C Compile    | C++ Compile | IPA Link |
| ✓            | ✓           | ✓        |

**Category:** Listing

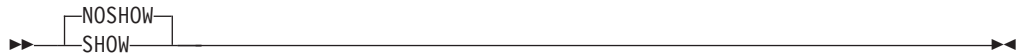

The **SHOWINC** option instructs the compiler to show, in both the compiler listing and the Pseudo-Assembly listing, all include files processed. In the listing, the compiler replaces all **#include** preprocessor directives with the source that is contained in the include file. This option only applies if you also specify the **SOURCE** option.

## SOURCE | NOSOURCE

**Default:** NOSOURCE

For the z/OS UNIX System Services utilities, the default for a regular compile is **NOSOURCE(/dev/fd1)**.

In the z/OS UNIX System Services environment, this option is turned on by specifying **-V** when using the **c89**, **cc** or **c++** commands.

| Option Scope |             |          |
|--------------|-------------|----------|
| C Compile    | C++ Compile | IPA Link |
| ✓            | ✓           | ✓        |

**Category:** Listing

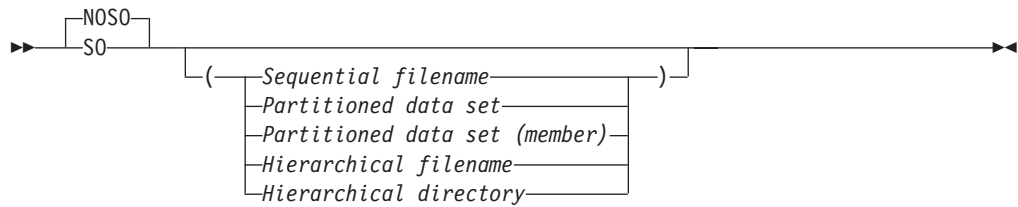

The SOURCE option generates a listing that shows the original source input statements plus any diagnostic messages.

If you specify SOURCE(*filename*), the compiler places the listing in the file that you specified. If you do not specify a file name for the SOURCE option, the compiler uses the SYSCPRT ddname if you allocated one. Otherwise, the compiler constructs the file name as follows:

- If you are compiling a data set, the compiler uses the source file name to form the name of the listing data set. The high-level qualifier is replaced with the userid under which the compiler is running, and .LIST is appended as the low-level qualifier.
- If the source file is a z/OS UNIX file, the listing is written to a file that has the name of the source file with a .lst extension in the current working directory.

The NOSOURCE option can optionally take a *filename* suboption. This *filename* then becomes the default. If you subsequently use the SOURCE option without a *filename* suboption, the compiler uses the *filename* that you specified in the earlier NOSOURCE.

**Example:** The following specifications have the same result:

```

CXX HELLO (NOSOURCE(/hello.lst) SOURCE)
CXX HELLO (SOURCE(/hello.lst))

```

If you specify SOURCE and NOSOURCE multiple times, the compiler uses the last specified option with the last specified suboption. For example, the following specifications have the same result:

```

CXX HELLO (NOSOURCE(/hello.lst) SOURCE(/n1.lst) NOSOURCE(/test.lst) SOURCE)
CXX HELLO (SOURCE(/test.lst))

```

**Notes:**

1. If you specify data set names with the SOURCE, LIST, or INLRPT option, the compiler combines all the listing sections into the last data set name specified.
2. If you use the following form of the command in a JES3 batch environment where xxx is an unallocated data set, you may get undefined results.  
SOURCE(xxx)

## SPILL | NOSPILL

**Default:** SPILL(128)

| Option Scope |             |          |
|--------------|-------------|----------|
| C Compile    | C++ Compile | IPA Link |
| ✓            | ✓           | ✓        |

**Category:** Object Code Control





The SPILL option specifies the size of the spill area to be used for the compilation. When too many registers are in use at once, the compiler saves the contents of some registers in temporary storage, called the spill area.

If you have to expand the spill area, you will receive a compiler message telling you the size to which you should increase it. Once you know the spill area that your source program requires, you can specify the required *size* (in bytes) as shown in the syntax diagram above. The maximum spill area size is 1073741823 bytes or  $2^{30}-1$  bytes. Typically, you will only need to specify this option when compiling very large programs with OPTIMIZE.

#### Notes:

1. There is an upper limit for the combined area for your spill area, local variables, and arguments passed to called functions at OPT. For best use of the stack, do not pass large arguments, such as structures, by value.
2. If you specify NOSPILL, the compiler defaults to SPILL(128).

You can specify the SPILL option using the **#pragma options** directive for C.

You can specify this option for a specific subprogram using the **#pragma option\_override(subprogram\_name, "OPT(SPILL,size)")** directive.

#### Effect on IPA Compile step

If you specify the SPILL option for any compilation unit in the IPA Compile step, the compiler generates information for the IPA Link step. This option also affects the regular object module if you request one by specifying the IPA(OBJECT)

#### Effect on IPA Link step

If you specify the SPILL option for the IPA Link step, the compiler sets the Compilation Unit values of the SPILL option that you specify. The IPA Link step Prolog listing section will display the value of this option.

If you do not specify the SPILL option in the IPA Link step, the setting from the IPA Compile step for each Compilation Unit will be used.

In either case, subprogram-specific SPILL options will be retained.

The IPA Link step merges and optimizes your application code, and then divides it into sections for code generation. Each of these sections is a partition. The IPA Link step uses information from the IPA Compile step to determine if a subprogram can be placed in a particular partition.

The initial overall SPILL value for a compilation unit is set to the IPA Link SPILL option value, if specified. Otherwise, it is the SPILL option that you specified during the IPA Compile step for the compilation unit.

The SPILL value for each subprogram in a partition is determined as follows:

- The SPILL value is set to the compilation unit SPILL value, unless a subprogram-specific SPILL option is present.
- During inlining, the caller subprogram SPILL value will be set to the maximum of the caller and callee SPILL values.

The overall SPILL value for a partition is set to the maximum SPILL value of any subprogram contained within that partition.

The option value that you specified for each IPA object file on the IPA Compile step appears in the IPA Link step Compiler Options Map listing section.

The Partition Map sections of the IPA Link step listing and the object module END information section display the value of the SPILL option. The Partition Map also displays any subprogram-specific SPILL values.

## SPLITLIST | NOSPLITLIST

**Default:** NOSPLITLIST

| Option Scope |             |          |
|--------------|-------------|----------|
| C Compile    | C++ Compile | IPA Link |
| ✓            | ✓           | ✓        |

**Category:** Listing



Normally, the default listing location is stdout or SYSPRT. You can instruct the compiler to output listing contents into a file by using the LIST or INLRPT options. This method can be useful when the source file is large and there is a large amount of detail in the listing. Writing the listing contents to a file, allows you to use an editor or a search utility to browse through the file. However, for the IPA Link phase, which processes the whole application instead of just one source file, there are situations when the listing file itself becomes too large, which can cause difficulties for an editor or search utility. The SPLITLIST option is designed to split a listing into multiple files so that it will be easier for you to browse and edit large listings.

The SPLITLIST compiler option enables the z/OS XL C/C++ compiler to write the IPA Link phase listing to multiple PDS members, PDSE members, or z/OS UNIX System Services files. The NOSPLITLIST option setting disables the splitting action. The SPLITLIST option is used only in the IPA Link phase, and the location of the files, which must be a PDS, PDSE, or z/OS UNIX file system directory, must be specified by the LIST or INLRPT option. If the LIST or INLRPT option is not used to specify a location, you will receive an error message.

The table below shows the names given to the generated listing sections if a z/OS UNIX file system directory name is specified. In the table, we assume the location is a directory called listing, and there are three partitions generated by the IPA Link phase.

*Table 28. Listing section names comparison for a specified z/OS UNIX file system directory*

| Listing section names generated with SPLITLIST | Listing section names generated with NOSPLITLIST |
|--|--|
| listing/part0                                  | Partition 0 listing                              |
| listing/part1                                  | Partition 1 listing                              |
| listing/part2                                  | Partition 2 listing                              |
| listing/objmap                                 | Object File Map                                  |

Table 28. Listing section names comparison for a specified z/OS UNIX file system directory (continued)

| Listing section names generated with SPLITLIST | Listing section names generated with NOSPLITLIST |
|--|--|
| listing/srcmap                                 | Source File Map                                  |
| listing/inlrpt                                 | Inline Report                                    |
| listing/options                                | IPA Link Options                                 |
| listing/cuopts                                 | Compiler Options Map                             |
| listing/globsym                                | Global Symbols Map                               |
| listing/messages                               | Messages and Summary                             |

The table below shows the names given to the generated listing sections if a PDS or PDSE name is specified. In the table, we assume the PDS or PDSE name is ACCNTING.LISTING, and that three partitions are generated by the IPA Link phase.

Table 29. Listing section names comparison for a specified PDS name

| Listing section names generated with SPLITLIST | Listing section names generated with NOSPLITLIST |
|--|--|
| ACCNTING.LISTING(PART0)                        | Partition 0 listing                              |
| ACCNTING.LISTING(PART1)                        | Partition 1 listing                              |
| ACCNTING.LISTING(PART2)                        | Partition 2 listing                              |
| ACCNTING.LISTING(OBJMAP)                       | Object File Map                                  |
| ACCNTING.LISTING(SRCMAP)                       | Source File Map                                  |
| ACCNTING.LISTING(INLRPT)                       | Inline Report                                    |
| ACCNTING.LISTING(OPTIONS)                      | IPA Link Options                                 |
| ACCNTING.LISTING(CUOPTS)                       | Compiler Options Map                             |
| ACCNTING.LISTING(GLOBSYM)                      | Global Symbols Map                               |
| ACCNTING.LISTING(MESSAGES)                     | Messages and Summary                             |

**Notes:**

1. The SPLITLIST option can only be specified in the IPA Link phase.
2. Repeating a SPLITLIST option is equivalent to specifying it once. The last one specified is the effective setting.
3. If the SPLITLIST option is specified but the effective location of the listing is not a z/OS UNIX file system directory, PDS data set, or PDSE data set, then a diagnostic message will be issued and the IPA Link phase return code will be at least 8.
4. A z/OS UNIX file system directory name must denote a z/OS UNIX directory which exists and is accessible by the user prior to the IPA Link. Otherwise, a diagnostic message will be issued and the minimum return code will be raised to 16.
5. The PDS name must denote a PDS or PDSE data set which exists and is accessible by the user prior to the IPA Link. Otherwise, a diagnostic message will be generated and the minimum return code will be raised to 16.

The following examples show how to use SPLITLIST:

```

# list must exist prior to executing the IPA link
#
mkdir list

# Generate listing sections corresponding to XREF and LIST
#
$(C89) -Wl,I,"XREF,LIST(./list)" -Wl,I,SPLITLIST -o a.out hello.o
# list must exist prior to executing the IPA link
#
mkdir list

# Since NOLIST is specified, only IPA(MAP) sections are generated
# However, the destination directory is the one specified in the NOLIST option
#
c89 -Wl,I,SPLITLIST -Wl,I,'NOLIST(./list)' -WI,MAP -o a.out hello.o
# list must exist prior to executing the IPA link
#
mkdir list

# Generate sections corresponding to INLRPT
#
$(C89) -Wl,I,"INLR(./list)" -Wl,I,SPLITLIST -o a.out hello.o

```

The following provides a JCL example for SPLITLIST:

```

//USRID1A JOB (359B,2326),'USRID1',
//          MSGLEVEL=(1,1),MSGCLASS=S,CLASS=A,NOTIFY=USRID1
/*JOBPARM  T=1,L=300
//ORDER    JCLLIB ORDER=(CBC.SCCNPRC)
//*-----
/* Compile
//*-----
//C0011L01 EXEC EDCC,
//          OUTFILE='USRID1.PASS1.OBJECT(SPLLIST),DISP=SHR',
// PARM.COMPILE=('IPA(NOLINK,NOOBJECT) OPT',
// 'RENT LO ')
//SYSIN    DD *,DLM='>'
int main()
{
    return 0;
}
/>
//*-----
/* IPA LINK
//*-----
//C0011L02 EXEC EDCC,
//          OUTFILE='USRID1.PASS2.OBJECT(SPLLIST),DISP=SHR',
// PARM.COMPILE=('LIST(USRID1.LISTPDS) IPA(LINK,MAP) OPT',
// 'RENT LO SPLITLIST')
//OBJECT DD DSN=USRID1.PASS1.OBJECT,DISP=SHR
//SYSIN    DD *,DLM='>'
          INCLUDE OBJECT(SPLLIST)
/>
//

```

### Effect on IPA Compile step

The SPLITLIST option will be ignored by the IPA Compile phase (since it does not generate a listing). If **-Wc,SPLITLIST** is used, the IPA Compile step will ignore it.

# SQL | NOSQL

**Default:** NOSQL

| Option Scope |             |          |
|--------------|-------------|----------|
| C Compile    | C++ Compile | IPA Link |
| ✓            | ✓           | ✓        |

**Category:** Object Code Control

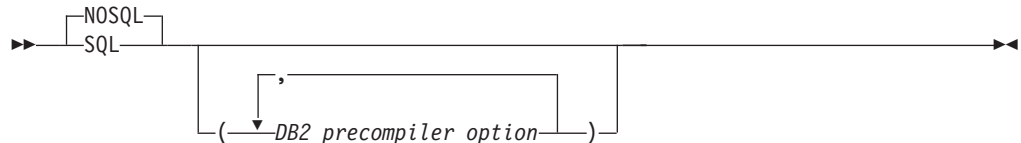

The SQL compiler option enables the z/OS XL C/C++ compiler to process embedded SQL statements. Use the SQL compiler option to enable the SQL statement coprocessor capability and to specify SQL statement coprocessor options. The SQL coprocessor options are only passed to the SQL statement coprocessor; the z/OS XL C/C++ compiler does not act on any of the options. Refer to *DB2 Application Programming and SQL Guide* for further information.

You may use this option to compile C and C++ programs containing embedded SQL statements, that have not been pre-compiled by the DB2 Precompiler. When you specify this option, the compiler writes the database request module (DBRM Bind file) to the ddname DBRMLIB.

**Note:** To use this option, the z/OS XL C/C++ compiler requires access to DB2 Version 7 or later. Ensure you specify the DB2 load module data set in your compile step STEPLIB.

To use this option with the supplied proc, specify the following items in your JCL:

```
//SQLCOMP EXEC EDCC,
// CPARM='SQL',
// INFILE=PAYROLL.SOURCE(MASTER)
//STEPLIB DD
// DD
// DD
// DD DSN=DSN710.SDNSLOAD,DISP=SHR
//DBRMLIB DD DSN=PAYROLL.DBRMLIB.DATA(MASTER),DISP=SHR
```

An SQL INCLUDE statement is treated identically to an #include directive. The following two lines are processed the same way by the compiler:

```
EXEC SQL INCLUDE name;
#include "name"
```

The library search order for SQL INCLUDE statements is the same as specified in the LSEARCH option or the USERLIB ddname. Nested SQL INCLUDE statements, that are not supported with the DB2 Precompiler, are supported by the SQL compiler option.

For C++, host variable names do not need to be unique, as they are previously required to be by the DB2 Precompiler. You may declare host variables, using the SQL BEGIN DECLARE SECTION and SQL END DECLARE SECTION statements, of the same name but in different lexical scopes.

**Example:** The same lexical scoping rules for C/C++ variables apply when they are used as host variables in SQL statements:

```
EXEC SQL BEGIN DECLARE SECTION;
int salary;
EXEC SQL END DECLARE SECTION;

main() {
  EXEC SQL BEGIN DECLARE SECTION; /* (1) */
  int salary;
  EXEC SQL END DECLARE SECTION; /* (2) */

  /* The local variable salary will be used here */
  EXEC SQL SELECT SALARY INTO :salary FROM ctab WHERE EMPNO = 12345;
}
```

If the local variable has not been declared as host variable, that is, the SQL BEGIN DECLARE SECTION statement (1) and SQL END DECLARE SECTION statement (2) are missing, you will get a compiler error.

## SSCOMM | NOSSCOMM

**Default:** NOSSCOMM

For LANGLVL(STDC99) and LANGLVL(EXTC99), the default is SSCOMM.

| Option Scope |             |          |
|--------------|-------------|----------|
| C Compile    | C++ Compile | IPA Link |
| ✓            |             | ✓        |

**Category:** Programming Language Characteristics Control



The SSCOMM option instructs the C compiler to recognize two slashes (//) as the beginning of a comment, which terminates at the end of the line. It will continue to recognize /\* \*/ as comments.

**Example:** If you include your z/OS XL C program in your JCL stream, be sure to change the delimiters so that your comments are recognized as z/OS XL C comments and not as JCL statements:

```
//COMPILE.SYSIN DD DATA,DLM=@@
#include <stdio.h>
void main(){
// z/OS XL C comment
printf("hello world\n");
// A nested z/OS XL C /* */ comment
}
@@
/* JCL comment
```

NOSSCOMM indicates that /\* \*/ is the only valid comment format.

**C++ Note:** You can include the same delimiter in your JCL for C++ source code, however you do not need to use the SSCOMM option.

## START | NOSTART

**Default:** START

| Option Scope |             |          |
|--------------|-------------|----------|
| C Compile    | C++ Compile | IPA Link |
| ✓            | ✓           | ✓        |

**Category:** Object Code Control

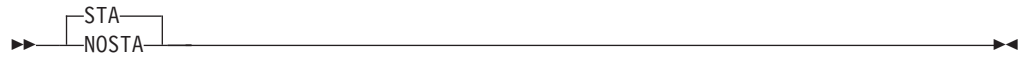

The START option specifies that CEESTART is to be generated whenever necessary.

NOSTART indicates that CEESTART is never to be generated.

Whenever you specify the START compiler option, a comment that indicates its use will be generated in your object module to aid you in diagnosing your program.

You can specify this option using the **#pragma options** directive for C.

### Effect on IPA Compile step

If you specify the START option for any compilation unit in the IPA Compile step, the compiler generates information for the IPA Link step. This option also affects the regular object module if you request one by specifying the IPA(OBJECT) option.

### Effect on IPA Link step

The IPA Link step uses the value of the START option that you specify for that step. It does not use the value that you specify for the IPA Compile step.

## STATICINLINE | NOSTATICINLINE

**Default:** NOSTATICINLINE

| Option Scope |             |          |
|--------------|-------------|----------|
| C Compile    | C++ Compile | IPA Link |
|              | ✓           | ✓        |

**Category:** Programming Language Characteristics Control



The STATICINLINE option treats an inline function as static instead of extern. (As of z/OS V1R2, the z/OS C/C++ compiler treats inline functions as extern. The z/OS V1R1 C/C++ compiler and previous versions of the OS/390 C/C++ compiler treated the inline functions as static.)

Specify the STATICINLINE option for compatibility with previous versions of the C++ compiler.

For example, using the `STATICINLINE` compiler option causes function `f` in the following declaration to be treated as static, even though it is not explicitly declared as such:

```
inline void f() { /*...*/};
```

Using the `NOSTATICINLINE` compiler option gives `f` external linkage.

## STRICT | NOSTRICT

**Default:** For `NOOPT` and `OPT(2)`, the default option is `STRICT`. For `OPT(3)`, the default option is `NOSTRICT`.

| Option Scope |             |          |
|--------------|-------------|----------|
| C Compile    | C++ Compile | IPA Link |
| ✓            | ✓           | ✓        |

**Category:** Object Code Control

For `NOOPT` and `OPT(2)`:



For `OPT(3)`:



The `STRICT` option instructs the compiler to perform computational operations in a rigidly-defined order such that the results are always determinable and recreatable.

`NOSTRICT` allows the compiler to reorder certain computations for better performance. However, the end result may differ from the result obtained when `STRICT` is specified.

In IEEE floating-point mode, `NOSTRICT` sets `FLOAT(MAF)`. To avoid this behavior, explicitly specify `FLOAT(NOMAF)`.

You can specify this option for a specific subprogram using the `#pragma option_override(subprogram_name, "OPT(STRICT)")` directive.

### Effect on IPA Compile step

The IPA Compile step generates information for the IPA Link step. This option also affects the regular object module if you request one by specifying the `IPA(OBJECT)` option.

### Effect on IPA Link step

The IPA Link step merges and optimizes the application code, and then divides it into sections for code generation. Each of these sections is a partition. The IPA Link step uses information from the IPA Compile step to ensure that an object is included in a compatible partition. See "FLOAT" on page 106 for more information on the effect of the `STRICT` option on the IPA Link step.



# STRICT\_INDUCTION | NOSTRICT\_INDUCTION

**Default:** NOSTRICT\_INDUCTION

**Note:** The **c99** compiler invocation command for a regular compile in the z/OS UNIX System Services environment uses STRICT\_INDUCTION as the default option.

| Option Scope |             |          |
|--------------|-------------|----------|
| C Compile    | C++ Compile | IPA Link |
| ✓            | ✓           | ✓        |

**Category:** Object Code Control



The STRICT\_INDUCTION option instructs the compiler to disable loop induction variable optimizations. These optimizations have the potential to alter the semantics of your program. Such optimizations can change the result of a program if truncation or sign extension of a loop induction variable occurs as a result of variable overflow or wrap-around.

The STRICT\_INDUCTION option only affects loops which have an induction (loop counter) variable declared as a different size than a register. Unless you intend such variables to overflow or wrap-around, use NOSTRICT\_INDUCTION.

## Effect on IPA Compile step

If you specify the STRICT\_INDUCTION option for any compilation unit in the IPA Compile step, the compiler generates information for the IPA Link step. This option also affects the regular object module if you request one by specifying the IPA(OBJECT) option.

## Effect on IPA Link step

The IPA Link step merges and optimizes your application's code, and then divides it into sections for code generation. Each of these sections is a partition. The IPA Link step uses information from the IPA Compile step to ensure that an object is included in a compatible partition.

The compiler sets the value of the STRICT\_INDUCTION option for a partition to the value of the first subprogram that is placed in the partition. During IPA inlining, subprograms with different STRICT\_INDUCTION settings may be combined in the same partition. When this occurs, the resulting partition is always set to STRICT\_INDUCTION.

You can override the setting of STRICT\_INDUCTION by specifying the option on the IPA Link step. If you do so, all partitions will contain that value, and the prolog section of the IPA Link step listing will display the value.

# SUPPRESS | NOSUPPRESS

Default: NOSUPPRESS

| Option Scope |             |          |
|--------------|-------------|----------|
| C Compile    | C++ Compile | IPA Link |
| ✓            | ✓           | ✓        |

Category: Debug/Diagnostic

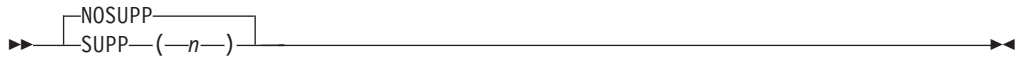

Note: *n* is a comma separated list of messages IDs.

The SUPPRESS option prevents certain compiler informational or warning messages from being printed to the listing file and to the terminal. For C, the message ID range that is affected is CCN3000 through CCN4399. For C++, the message ID range that is affected is CCN5000 to CCN6999, and CCN7500 to CCN8999. Note that this option has no effect on linker or operating system messages. Compiler messages that cause compilation to stop, such as (S) and (U) level messages cannot be suppressed.

## Effect on IPA Link step

The SUPPRESS option has the same effect on the IPA Link step that it does on a regular compilation.

# TARGET

Default: TARGET(LE, CURRENT)

| Option Scope |             |          |
|--------------|-------------|----------|
| C Compile    | C++ Compile | IPA Link |
| ✓            | ✓           | ✓        |

Category: Program Execution and Object Code Control

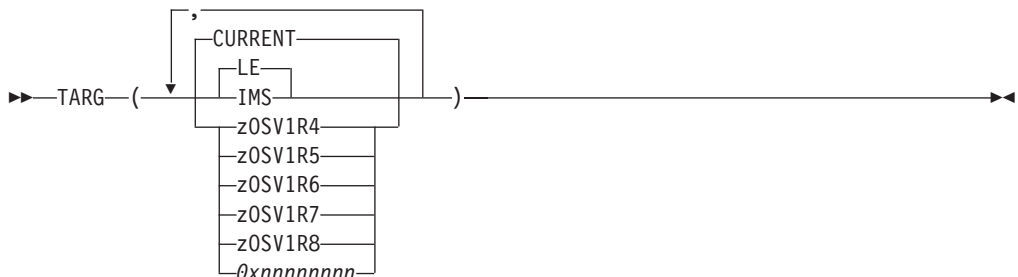

Note: Suboptions are not case-sensitive.

With the TARGET option, you can specify the run-time environment and release for your program's object module that z/OS XL C/C++ generates. This enables you to generate code that is downward compatible with earlier levels of the operating

system while at the same time disallowing you from using library functions not available on the targeted release. With the TARGET option, you can compile and link an application on a higher level system, and run the application on a lower level system.

To use the TARGET option, select a run-time environment of either LE or IMS. Then select the desired release, for example, z0SV1R4. If you do not select a run-time environment or release, the compiler uses a default of TARGET(LE, CURRENT).

TARGET() Generates object code to run under z/OS Language Environment. It is the same as TARGET(LE,CURRENT).

The following suboptions target the run-time environment:

TARGET(LE) Generates object code to run under z/OS Language Environment. This is the default.

TARGET(IMS) Generates object code to run under the Information Management System (IMS) subsystem. If you are compiling the main program, you must also specify the PLIST(OS) option. TARGET(IMS) is not supported with LP64.

For more information about these suboptions refer to “TARGET run-time environment suboptions (LE,IMS)” on page 203.

The following suboptions target the release at program run time:

TARGET(CURRENT) Generates object code that runs under the same version of z/OS with which the compiler is included. As the compiler is included with z/OS V1R8, TARGET(CURRENT) is the same as TARGET(zOSV1R8). This is the default. <sup>2</sup>

**Note:** The binder has an option called COMPAT that must be used when generating code to be run on an earlier version of the operating system. The C/C++ cataloged procedures and the z/OS UNIX System Services c99/c89/c++/cc utilities set the COMPAT option to CURR. As of z/OS V1R3, the binder output defaults to PM4.

TARGET(zOSV1R4) Generates object code to run under z/OS Version 1 Release 4 and subsequent releases.

TARGET(zOSV1R5) Generates object code to run under z/OS Version 1 Release 5 and subsequent releases.

TARGET(zOSV1R6) Generates object code to run under z/OS Version 1 Release 6 and subsequent releases.

TARGET(zOSV1R7) Generates object code to run under z/OS Version 1 Release 7 and subsequent releases.

---

2. Note that for some releases of z/OS, z/OS XL C/C++ might not include a new release of the compiler. The same release of the compiler is then included with more than one z/OS release. The compiler is designed to run on all these z/OS releases. In this case, the compiler sets CURRENT to the z/OS release on which it is running. (It does so by querying the Language Environment Library version of the system.) You can specify a zOSVxRy suboption that corresponds to a release that is earlier or the same as CURRENT. You cannot specify a zOSVxRy suboption that corresponds to a release later than CURRENT.

|      |                    |  |
|------|--------------------|--|
| <br> | TARGET(zOSV1R8)    | Generates object code to run under z/OS Version 1 Release 8 and subsequent releases.   |
|      | TARGET(0xnnnnnnnn) | An eight-digit hexadecimal literal string that specifies an operating system level. This string is intended for library providers and vendors to test header files on future releases and is an advanced feature. Most applications should use the other release suboptions. The layout of this literal is the same as the <code>__TARGET_LIB__</code> macro. For more information on using this literal, please see “Using the hexadecimal string literal suboption” on page 201. |

For more information about these suboptions refer to “TARGET release suboptions.”

The compiler generates a comment that indicates the value of TARGET in your object module to aid you in diagnosing problems in your program.

If you specify more than one suboption from each group of suboptions (that is, the run-time environment, or the release) the compiler uses the last specified suboption for each group.

The compiler applies and resolves defaults after it views all the entered suboptions. For example, TARGET(LE,0x41050000, IMS, zOSV1R6, LE) resolves to TARGET(LE, zOSV1R6). TARGET(LE, 0x41050000, IMS, zOSV1R6) resolves to TARGET(IMS, zOSV1R6). TARGET(LE, 0x41050000, IMS) resolves to TARGET(IMS, 0x41050000).

The default value of the ARCHITECTURE compiler option depends on the value of the TARGET release suboption. For TARGET(zOSV1R6) and above, the default is ARCH(5). For TARGET(zOSV1R5) and below, the default is ARCH(2).

### TARGET release suboptions

The TARGET release suboptions (CURRENT, zOSV1R4, zOSV1R5, zOSV1R6, zOSV1R7 and zOSV1R8) help you to generate code that can be executed on a particular release of a z/OS system, and on subsequent releases.

In order to use these suboptions, you must:

- Use the z/OS V1R8 class library header files (found in the CBC.SCLBH.\* data sets) during compilation

For example, to generate code that will execute on a z/OS V1R4 system, using a z/OS V1R8 application development system, you must:

- Specify the compiler option TARGET(zOSV1R4) on the C/C++ compiles. Note: The programmer is responsible for ensuring that they are not exploiting any Language Environment functions that are unavailable on z/OS V1R4.
- Use the z/OS V1R8 Language Environment data sets (CEE.SCEE\*) during the assembly, compilation, pre-link, link-edit, and bind phases.
- Use the z/OS V1R8 class library header data sets (CBC.SCLBH.\*) during compilation. Use the z/OS V1R4 class library data sets (SCLBCPP, SCLBOBC, SCLBOXL, SCLBSID, SCLBXL) during pre-link, link-edit, and bind.

See Appendix A, “Prelinking and linking z/OS XL C/C++ programs,” on page 549 for details on prelinking and linking applications.

These compiler suboptions will not allow you to exploit new functions provided on the newer release. Rather, they allow you to build an application on a newer release and run it on an older release.

When you invoke the TARGET(OSVxRy) release suboptions, the compiler sets the `__TARGET_LIB__` macro. See *z/OS XL C/C++ Language Reference* for more information about this macro.

**Using the hexadecimal string literal suboption:** This hexadecimal literal string enables you to specify an operating system level. It is an advanced feature that is intended for library providers and vendors to test header files on future releases. Most applications should use the other release suboptions instead of this string literal. The layout of this literal is the same as the `__TARGET_LIB__` macro.

The compiler checks to ensure that there are exactly 8 hexadecimal digits. The compiler performs no further validation checks.

The compiler uses a two step process to specify the operating system level:

- The hexadecimal value will be used, as specified, to set the `__TARGET_LIB__` macro.
- The compiler determines the operating system level implied by this literal.

If the level corresponds to a valid suboption name, the compiler behaves as though that suboption is specified. Otherwise, the compiler uses the next lower operating system suboption name. If there is no lower suboption name, the compiler behaves as though you have specified an unsupported release. Note that the compiler sets the `__TARGET_LIB__` macro to the value that you specify, even if it does not correspond to a valid operating system level. Following are some examples:

TARGET(0x41070000)  
Equivalent to TARGET(zOSV1R7).

TARGET(0xA3120000)  
This does not match any existing operating system release suboption name. The next lower operating system level implied by this literal, which the compiler considers valid, is CURRENT. Thus, the compiler sets the `__TARGET_LIB__` macro to 0xA3120000, and behaves as though you have specified TARGET(CURRENT).

TARGET(0x41060001)  
This does not match any existing operating system release suboption name because of the 1 in the last digit. The next lower operating system level implied by this literal which the compiler considers valid is z/OS V1R6. Thus, the compiler sets the `__TARGET_LIB__` macro to 0x41060001, and behaves as though you have specified TARGET(zOSV1R6).

TARGET(0x21010000)  
This does not match any existing operating system release suboption name, and specifies a release earlier than the earliest supported release. In this instance, the compiler sets the `__TARGET_LIB__` macro to 0x21010000, and behaves as though you have specified an unsupported release.

**Restrictions for C/C++:** All input libraries used during the application build process must be the appropriate level for the target release.

- The current level of the Language Environment data sets can be used to target to previous releases. Use these Language Environment data sets during the assembly, compilation, pre-link, link-edit, and bind phases.
- For C++ class libraries, use the current release class library header files during compilation; use the class library data sets for the targeted release during pre-link, link-edit, and bind.
- Ensure that any other libraries incorporated in the application, are compatible with the target release.

While there are no restrictions on the use of ARCH and TUNE with TARGET, ensure that the level specified is consistent with the target hardware.

| TARGET Release Suboption  | Restrictions   |
|---|--|
| <ul style="list-style-type: none"> <li>• CURRENT</li> <li>• zOSV1R8</li> <li>• zOSV1R7</li> </ul> | <ul style="list-style-type: none"> <li>• TARGET(IMS) is not supported for LP64. The compiler will issue a message and ignore the option.</li> <li>• ARCH(5) is the default.</li> </ul>   |
| <ul style="list-style-type: none"> <li>• zOSV1R6</li> </ul>                                       | <ul style="list-style-type: none"> <li>• LANGLVL(NEWEXCP) and <b>#pragma operator_new</b> is not supported.</li> </ul>   |
| <ul style="list-style-type: none"> <li>• zOSV1R5</li> <li>• zOSV1R4</li> </ul>                    | <ul style="list-style-type: none"> <li>• The application built from the IPA(PDF1) compiler option can only be run on the current system.</li> <li>• LP64, WARN64, ENUM(8), and ENUM(INTLONG) (C++ only) are not supported.</li> <li>• ARCH(2) is the default.</li> </ul> |

Only options or features that cannot be supported on that operating system level are disabled. For example, STRICT\_INDUCTION is allowed on all operating system levels. An option or feature that is disabled by one operating system level is also disabled by all earlier operating system levels.

**Restrictions for C:** See the *z/OS XL C/C++ Language Reference* for information on the **#pragma target()** directive.

If you specify TARGET(zOSVxRy) on the command line, and one or more of the disallowed options is specified, the compiler issues a warning message and disables the option.

**Effect on IPA Compile step:** If you specify the TARGET option for any compilation unit in the IPA Compile step, the compiler generates information for the IPA Link step. This option also affects the regular object module if you request one by specifying the IPA(OBJECT) option.

When you are performing the IPA Compile to generate IPA Object files, ensure that you are using the appropriate header library files.

**Effect on IPA Link step:** If you specify TARGET on the IPA Link step, it overrides the TARGET value that you specified for the IPA Compile step.

The IPA Link step accepts the release suboptions, for example, CURRENT or zOSV1R7. However, when using TARGET suboptions ensure that:

- All IPA Object files are compiled with the appropriate TARGET suboption and header files

- All non-IPA object files are compiled with the appropriate TARGET suboption and header files
- All other input libraries are compatible with the specified run-time release

### TARGET run-time environment suboptions (LE,IMS)

The TARGET Run-time Environment suboption allows you to select a run-time environment of either Language Environment or IMS.

**Effect on IPA Compile step:** If you specify the TARGET option for any compilation unit in the IPA Compile step, the compiler generates information for the IPA Link step. This option also affects the regular object module if you request one by specifying the IPA(OBJECT) option.

**Effect on IPA Link step:** If you specify TARGET on the IPA Link step, it has the following effects:

- It overrides the TARGET value that you specified for the IPA Compile step.
- It overrides the value that you specified for **#pragma runopts(ENV)**. If you specify TARGET(LE) or TARGET(), the IPA Link step specifies **#pragma runopts(ENV(MVS))**. If you specify TARGET(IMS), the IPA Link step specifies **#pragma runopts(ENV(IMS))**.
- It may override the value that you specified for **#pragma runopts(PLIST)**, which specifies the run-time option during program execution. If you specify TARGET(LE) or TARGET(), and you set the value set for the PLIST option to something other than HOST, the IPA Link step sets the values of **#pragma runopts(PLIST)** and the PLIST compiler option to IMS. If you specify TARGET(IMS), the IPA Link step unconditionally sets the value of **#pragma runopts(PLIST)** to IMS.

## TEMPINC | NOTEMPINC

**Default:** For a PDS directory, the default option is TEMPINC(TEMPINC). For a z/OS UNIX System Services file system directory, the default option is TEMPINC(/.tempinc).

**Note:** The **c++** compiler invocation command for a regular compile in the z/OS UNIX environment uses TEMPINC(tempinc) as the default option.

| Option Scope |             |          |
|--------------|-------------|----------|
| C Compile    | C++ Compile | IPA Link |
|              | ✓           |          |

**Category:** File Management

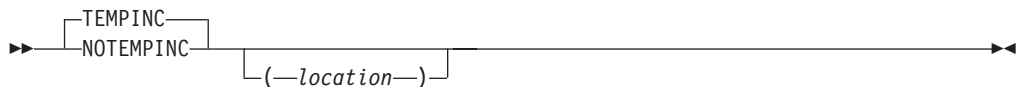

TEMPINC(*location*) places all template instantiation files into *location*, which may be a PDS or a z/OS UNIX file system directory. If you do not specify a *location*, the compiler places all template instantiation files in a default location. If the source resides in a data set, the default location is a PDS with a low-level qualifier of



TEMPINC. The high-level qualifier is the userid under which the compiler is running. If the source resides in a z/OS UNIX file, the default location is the z/OS UNIX file system directory `./tempinc`.

The NOTEMPINC option can optionally take a *filename* suboption. This *filename* then becomes the default. If you subsequently use the TEMPINC option without a *filename* suboption, then the compiler uses the *filename* that you specified in the earlier NOTEMPINC. For example, the following specifications have the same result:

```
CXX HELLO (NOTEMPINC(/hello) TEMPINC
CXX HELLO (TEMPINC(/hello)
```

If you specify TEMPINC and NOTEMPINC multiple times, the compiler uses the last specified option with the last specified suboption. For example, the following specifications have the same result:

```
CXX HELLO (NOTEMPINC(/hello) TEMPINC(/n1) NOTEMPINC(/test) TEMPINC
CXX HELLO (TEMPINC(/test)
```

If you have large numbers of recursive templates, consider using FASTT. See “FASTTEMPINC | NOFASTTEMPINC” on page 104 for details.

**Note:** If you use the following form of the command in a JES3 batch environment where xxx is an unallocated data set, you may get undefined results.

```
TEMPINC(xxx)
```

### Effect on IPA Link step

The IPA Link step issues a diagnostic message if you specify the TEMPINC option for that step.

## TEMPLATERECOMPILE | NOTEMPLATERECOMPILE

**Default:** TEMPLATERECOMPILE

| Option Scope |             |          |
|--------------|-------------|----------|
| C Compile    | C++ Compile | IPA Link |
|              | ✓           |          |

**Category:** File Management



The TEMPLATERECOMPILE option helps to manage dependencies between compilation units that have been compiled using the TEMPLATEREGISTRY option. Given a program in which multiple compilation units reference the same template instantiation, the TEMPLATEREGISTRY option nominates a single compilation unit to contain the instantiation. No other compilation units will contain this instantiation. Duplication of object code is thereby avoided. If a source file that has been compiled previously is compiled again, the TEMPLATERECOMPILE option consults the template registry to determine whether changes to this source file have necessitated the recompile of other compilation units. This can occur when the source file has changed in such a way that it no longer references a given instantiation and the corresponding object file previously contained the instantiation. If so, affected compilation units will be recompiled automatically.



The `TEMPLATERECOMPILE` option requires that object files generated by the compiler remain in the PDS or subdirectory to which they were originally written. If your automated build process moves object files from their original PDS or subdirectory, use the `NOTEMPLATERECOMPILE` option whenever `TEMPLATEREGISTRY` is enabled.

### Effect on IPA Link step

The IPA Link step does not accept the `TEMPLATERECOMPILE` option. The compiler issues a warning message if you specify this option in the IPA Link step.

## TEMPLATEREGISTRY | NOTEMPLATEREGISTRY

**Default:** NOTEMPLATEREGISTRY

| Option Scope |             |          |
|--------------|-------------|----------|
| C Compile    | C++ Compile | IPA Link |
|              | ✓           | ✓        |

**Category:** File Management



The `TEMPLATEREGISTRY` option maintains records of all templates as they are encountered in the source and ensures that only one instantiation of each template is made. The first time that the compiler encounters a reference to a template instantiation, that instantiation is generated and the related object code is placed in the current object file. Any further references to identical instantiations of the same template in different compilation units are recorded but the redundant instantiations are not generated. No special file organization is required to use the `TEMPLATEREGISTRY` option. If you do not specify a location, the compiler places all template registry information in a default location. If the source resides in a data set, the default location is a sequential data set, whose high-level qualifier is the userid under which the compiler is running, with `.TEMPLREG` appended as the low-level qualifier. If the source resides in a z/OS UNIX System Services file, the default location is the z/OS UNIX file `./templreg`. If a file currently exists with the name of the file name used for `TEMPLATEREGISTRY`, then that file will be overwritten. For more information on using the `TEMPLATEREGISTRY` option, see *z/OS XL C/C++ Programming Guide*.

**Note:** `TEMPINC` and `TEMPLATEREGISTRY` cannot be used together because they are mutually exclusive. If you specify `TEMPLATEREGISTRY`, then you set `NOTEMPINC`. If you use the following form of the command in a JES3 batch environment where `xxx` is an unallocated data set, you may get undefined results.

```
TEMPLREG(xxx)
```

### Effect on IPA Link step

The IPA Link step issues a diagnostic message if you specify the `TEMPLATEREGISTRY` option for that step.

## TERMINAL | NOTERMINAL

**Default:** TERMINAL

| Option Scope |             |          |
|--------------|-------------|----------|
| C Compile    | C++ Compile | IPA Link |
| ✓            | ✓           | ✓        |

**Category:** Debug/Diagnostic

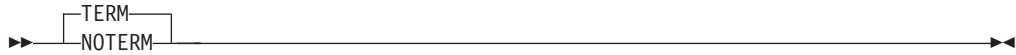

The TERMINAL option directs all of the diagnostic messages of the compiler to stderr.

If you specify NOTERMINAL, then no diagnostic messages are sent to stderr. Under z/OS batch, the default for stderr is SYSPRINT.

If you specify the PPOONLY option, the compiler turns on TERM.

### Effect on IPA Link step

The TERMINAL compiler option has the same effect on the IPA Link step as it does on a regular compile step.

## TEST | NOTEST

**Default:** For C++, the default option is NOTEST(HOOK). For C, the default option is: NOTEST(HOOK,SYM,BLOCK,LINE,PATH).

The default for the z/OS UNIX System Services utilities is NOTEST.

**Note:** In the z/OS UNIX environment, **-g** turns on TEST.

| Option Scope |             |          |
|--------------|-------------|----------|
| C Compile    | C++ Compile | IPA Link |
| ✓            | ✓           | ✓        |

**Category:** Debug/Diagnostic

The TEST suboptions that are common to C compile, C++ compile, and IPA Link steps are:



| <b>HOOK  <br/>NOHOOK</b> | <b>When NOOPT is in effect</b>  | <b>When OPT is in effect</b>   |
|--------------------------|---|--|
| <b>HOOK</b>              | <ul style="list-style-type: none"> <li>For C++ compile, generates all possible hooks.</li> <li>For C compile, generates all possible hooks based on current settings of BLOCK, LINE, and PATH suboptions.</li> <li>For IPA Link, generates Function Entry, Function Exit, Function Call, and Function Return hooks.</li> <li>For C++ compile, generates symbol information.</li> <li>For C compile, generates symbol information unless NOSYM is specified.</li> <li>For IPA Link, does not generate symbol information.</li> </ul> | <ul style="list-style-type: none"> <li>Generates Function Entry, Function Exit, Function Call and Function Return hooks.</li> <li>Does not generate symbol information.</li> </ul> |
| <b>NOHOOK</b>            | <ul style="list-style-type: none"> <li>Does not generate any hooks.</li> <li>For C++ compile, generates symbol information.</li> <li>For C compile, generates symbol information based on the current settings of SYM and BLOCK.</li> <li>For IPA Link, does not generate any symbol information.</li> </ul>  | <ul style="list-style-type: none"> <li>Does not generate any hooks.</li> <li>Does not generate symbol information.</li> </ul>  |

The TEST suboptions generate symbol tables and program hooks. Debug Tool uses these tables and hooks to debug your program. The Performance Analyzer uses these hooks to trace your program. The choices you make when compiling your program affect the amount of Debug Tool function available during your debugging session. These choices also impact the ability of the Performance Analyzer to trace your program.

To look at the flow of your code with Debug Tool, or to trace the flow of your code with the Performance Analyzer, use the HOOK suboption with OPT in effect. These suboptions generate function entry, function exit, function call, and function return hooks. They do not generate symbol information.

When NOOPT is in effect, and you use the HOOK suboption, the debugger runs slower, but all Debug Tool commands such as AT ENTRY \* are available. You must specify the HOOK suboption in order to trace your program with the Performance Analyzer.

If you specify the NOTEST option, debugging information is not generated and you cannot trace your program with the Performance Analyzer.

In order for the debugger to access the source lines, the primary source file of a compilation unit should come from one file (or sequential data set or PDS member), and not be the result of concatenated DD statements. This is because only the name of the first data set is known to the compiler reading the concatenation; the debug information generated in this case would contain only the first data set name. All the source files, including header files, should not be temporary files, and should be available to the debugger under the same name as used during compilation.

You can use the CSECT option with the TEST option to place your debug information in a named CSECT. This enables the compiler and linker to collect the debug information in your module together, which may improve the run-time performance of your program.

If you specify the INLINE and TEST compiler options when NOOPTIMIZE is in effect, INLINE is ignored.

If you specify the TEST option, the compiler turns on GONUMBER.

You can specify this option using the **#pragma options** directive for C.

**Note:** If your code uses any of the following, you cannot debug it with the MFI Debug Tool:

- IEEE code
- Code that uses the long long data type
- Code that runs in a POSIX environment

You must use either the C/C++ Productivity Tools for OS/390 or dbx.

### Additional z/OS XL C compile suboptions

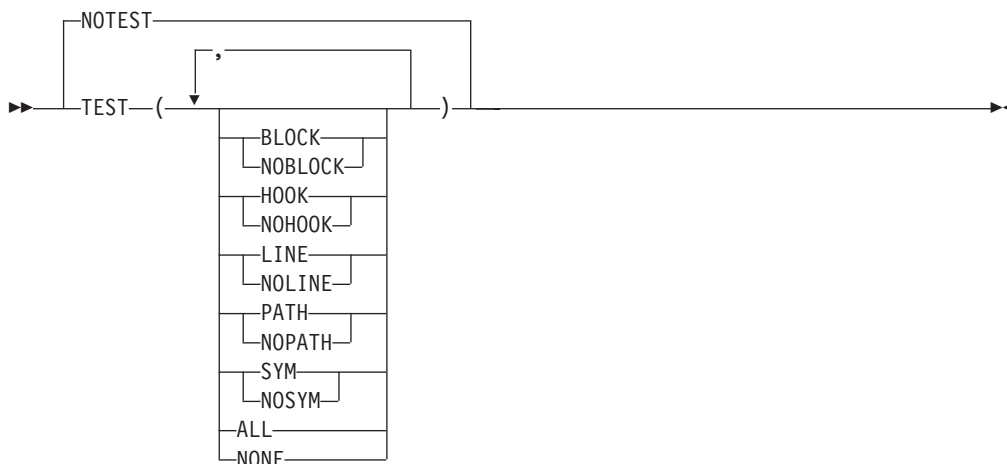

The TEST suboptions BLOCK, LINE, and PATH regulate the points where the compiler inserts program hooks. When you set breakpoints, they are associated with the hooks which are used to instruct Debug Tool where to gain control of your program.

The symbol table suboption SYM regulates the inclusion of symbol tables into the object output of the compiler. Debug Tool uses the symbol tables to obtain information about the variables in the program.

- SYM** Generates symbol tables in the object output of the program that give you access to variables and other symbol information.
- You can reference all program variables by name, allowing you to examine them or use them in expressions.
  - You can use the Debug Tool command GOTO to branch to a label (paragraph or section name).
  - The Performance Analyzer does not use symbol information. Specify NOSYM if you want to trace the program with the Performance Analyzer.

**BLOCK**  
Inserts only block entry and exit hooks into the object output of the

program. A block is any number of data definitions, declarations, or statements that are enclosed within a single set of braces. BLOCK also creates entry hooks and exit hooks for nested blocks. If SYM is enabled, symbol tables are generated for variables local to these nested blocks.

- You can only gain control at entry and exit of blocks.
- Issuing a command such as STEP causes your program to run, until it reaches the exit point.
- The Performance Analyzer does not use block entry and exit hooks. Specify NOBLOCK if you want to trace the program with the Performance Analyzer.

**LINE** Generates hooks at most executable statements. Hooks are not generated for the following:

- Lines that identify blocks (lines that contain braces)
- Null statements
- Labels
- Statements that begin in an #include file
- The Performance Analyzer does not use statement hooks. Specify NOLINE if you want to trace the program with the Performance Analyzer.

**PATH** Generates hooks at all path points; for example, hooks are inserted at if-then-else points.

- This option does not influence the generation of entry and exit hooks for nested blocks. You must specify the BLOCK suboption if you desire such hooks.
- Debug Tool can gain control only at path points and block entry and exit points. If you attempt to STEP through your program, Debug Tool gains control only at statements that coincide with path points, giving the appearance that not all statements are executed.
- The Debug Tool command GOTO is valid only for statements and labels that coincide with path points.
- The Performance Analyzer uses function call and function return hooks. Specify PATH if you want to trace the program with the Performance Analyzer.

**ALL** Inserts block and line hooks, and generates symbol table. Hooks are generated at all statements, all path points (if-then-else, calls, and so on), and all function entry and exit points.

ALL is equivalent to TEST(HOOK, BLOCK, LINE, PATH, SYM).

**NONE** Generates all compiled-in hooks only at function entry and exit points. Block hooks and line hooks are not inserted, and the symbol tables are suppressed.

TEST(NONE) is equivalent to TEST(HOOK, NOBLOCK, NOLINE, NOPATH, NOSYM).

**Note:** When the OPTIMIZE and TEST options are both specified, the TEST suboptions are set by the compiler to TEST(HOOK, NOBLOCK, NOLINE, NOPATH, NOSYM) regardless of what you have specified. The behavior of the TEST option in this case is as described in the table in the z/OS XL C/C++ section of the TEST | NOTEST option for the HOOK suboption.

For z/OS XL C compile, you can specify the TEST | NOTEST option on the command line and in the #pragma options preprocessor directive. When you use both methods, the option on the command line takes precedence. For example, if

you usually do not want to generate debugging information when you compile a program, you can specify the NOTEST option on a **#pragma options** preprocessor directive. When you do want to generate debugging information, you can then override the NOTEST option by specifying TEST on the command line rather than editing your source program. Suboptions that you specified in a **#pragma options (NOTEST)** directive, or with the NOTEST compiler option, are used if TEST is subsequently specified on the command line.

### Effect on IPA Compile step

On the IPA Compile step, you can specify all of the TEST suboptions that are appropriate for the language of the code that you are compiling. However, they affect processing only if you requested code generation, and only the conventional object file is affected. If you specify the NOOBJECT suboption of the IPA compiler option on the IPA Compile step, the IPA Compile step ignores the TEST option.

### Effect on IPA Link step

The IPA Link step supports only the TEST, TEST(HOOK), TEST(NOHOOK), and NOTEST options. If you specify TEST(HOOK) or TEST, the IPA Link step generates function call, entry, exit, and return hooks. It does not generate symbol table information. If you specify TEST(NOHOOK), the IPA Link step generates limited debug information without any hooks. If you specify any other TEST suboptions for the IPA Link step, it turns them off and issues a warning message.

**Note:** See “DEBUG | NODEBUG” on page 91 for more information on debugging applications linked with IPA.

## TMPLPARSE

**Default:** TMPLPARSE(NO)

| Option Scope |             |          |
|--------------|-------------|----------|
| C Compile    | C++ Compile | IPA Link |
|              | ↙           |          |

**Category:** Programming Language Characteristics Control



The TMPLPARSE option controls whether parsing and semantic checking are applied to template definitions or only to template instantiations. The TMPLPARSE option applies to class template definitions as well, for example, the class member list is skipped when the template is seen and is only parsed if the class template is instantiated.

The TMPLPARSE option supports the following suboptions:

**no** Do not parse the template implementations until they are instantiated. This is the default.

**warning**

Parses template implementations and issues warning messages for semantic errors.

**error** Treats problems in template implementations as errors, even if the template is not instantiated.

This option applies to template definitions but not their instantiations. Regardless of the setting of this option, error messages are produced for problems that appear outside definitions. For example, errors found during the parsing or semantic checking of constructs always cause error messages. Function template parameter lists must always be parsed so that the function can be identified. Errors in a function template parameter list always cause error messages.

### Effect on IPA Link step

The IPA Link step issues a diagnostic message if you specify the TEMPLPARSE option for that step.

## TUNE

**Default:** TUNE(5)

| Option Scope |             |          |
|--------------|-------------|----------|
| C Compile    | C++ Compile | IPA Link |
| ✓            | ✓           | ✓        |

**Category:** Object Code Control

►►—TUNE—(—n—)—————►►

The TUNE option specifies the architecture for which the executable program will be optimized. The TUNE level controls how the compiler selects and orders the available machine instructions, while staying within the restrictions of the ARCH level in effect. It does so in order to provide the highest performance possible on the given TUNE architecture from those that are allowed in the generated code. It also controls instruction scheduling (the order in which instructions are generated to perform a particular operation). Note that TUNE impacts performance only; it does not impact the processor model on which you will be able to run your application.

Select TUNE to match the architecture of the machine where your application will run most often. Use TUNE in cooperation with ARCH. TUNE must always be greater or equal to ARCH because you will want to tune an application for a machine on which it can run. The compiler enforces this by adjusting TUNE up rather than ARCH down. TUNE does not specify where an application can run. It is primarily an optimization option. For many models, the best TUNE level is not the best ARCH level. For example, the correct choices for model 9672-Rx5 (G4) are ARCH(2) and TUNE(3). For more information on the interaction between TUNE and ARCH see “ARCHITECTURE” on page 72.

**Note:** If the TUNE level is lower than the specified ARCH level, the compiler forces TUNE to match the ARCH level or uses the default TUNE level, whichever is greater.

Specify the group to which a model number belongs as a sub-parameter. If you specify a model which does not exist or is not supported, a warning message is issued stating that the suboption is invalid and that the default will be used.

Current models that are supported:

- 0 This option generates code that is executable on all models, but it will not be able to take advantage of architectural differences on the models specified below.
- 1 This option generates code that is executable on all models but that is optimized for the following models:
  - 9021-520, 9021-640, 9021-660, 9021-740, 9021-820, 9021-860, and 9021-900
  - 9021-xx1, 9021-xx2, and 9672-Rx2 (G1)
- 2 This option generates code that is executable on all models but that is optimized for the following models:
  - 9672-Rx3 (G2), 9672-Rx4 (G3), and 2003
  - 9672-Rx1, 9672-Exx, and 9672-Pxx
- 3 This option generates code that is executable on all models but that is optimized for the following and follow-on models: 9672-Rx5 (G4), 9672-xx6 (G5), and 9672-xx7 (G6).
- 4 This option generates code that is executable on all models but that is optimized for the model 2064-100 (z/900).
- 5 This option is the default. This option generates code that is executable on all models but that is optimized for the model 2064-100 (z/900) in z/Architecture mode.
- 6 This option generates code that is executable on all models, but is optimized for the 2084-xxx models.
- 7 This option generates code that is executable on all models, but is optimized for the 2094-xxx models.

**Note:** For the above system machine models, x indicates any value. For example, 9672-Rx4 means 9672-RA4 through to 9672-RY4 and 9672-R14 through to 9672-R94 (the entire range of G3 processors), not just 9672-RX4.

A comment that indicates the level of the TUNE option will be generated in your object module to aid you in diagnosing your program.

You can specify this option using the **#pragma options** directive for C.

### Effect on IPA Compile step

If you specify the TUNE option for any compilation unit in the IPA Compile step, the compiler saves information for the IPA Link step. This option also affects the regular object module if you request one by specifying the IPA(OBJECT) option.

### Effect on IPA Link step

The IPA Link step merges and optimizes the application code, and then divides it into sections for code generation. Each of these sections is a partition.

If you specify the TUNE option for the IPA Link step, it uses the value of the option you specify. The value you specify appears in the IPA Link step Prolog listing section and all Partition Map listing sections.

If you do not specify the option on the IPA Link step, the value it uses for a partition depends upon the TUNE option you specified during the IPA Compile step for any compilation unit that provided code for that partition. If you specified the same TUNE value for all compilation units, the IPA Link step uses that value. If you specified different TUNE values, the IPA Link step uses the highest value of TUNE.



If the resulting level of TUNE is lower than the level of ARCH, TUNE is set to the level of ARCH.

The Partition Map section of the IPA Link step listing, and the object module display the final option value for each partition. If you override this option on the IPA Link step, the Prolog section of the IPA Link step listing displays the value of the option.

The Compiler Options Map section of the IPA Link step listing displays the value of the TUNE option that you specified on the IPA Compile step for each object file.

## UNDEFINE

**Default:** not applicable

| Option Scope |             |          |
|--------------|-------------|----------|
| C Compile    | C++ Compile | IPA Link |
| ✓            | ✓           | ✓        |

**Category:** Preprocessor



UNDEFINE(*name*) removes any value that *name* may have and makes its value undefined. For example, if you set OS2 to 1 with DEF(OS2=1), you can use the UNDEF(OS2) option to remove that value.

In the z/OS UNIX System Services environment, you can unset variables by specifying -U when using the **c89**, **cc**, or **c++** commands.

**Note:** **c89** preprocesses -D and -U flags before passing them to the compiler. **xlc** just passes -D and -U to the compiler, which interprets them as DEFINE and UNDEFINE. For more information, see Chapter 20, “c89 — Compiler invocation using host environment variables,” on page 489 or Chapter 21, “xlc — Compiler invocation using a customizable configuration file,” on page 527.

## UNROLL

**Default:** UNROLL(AUTO)

| Option Scope |             |          |
|--------------|-------------|----------|
| C Compile    | C++ Compile | IPA Link |
| ✓            | ✓           | ✓        |

**Category:** Object Code Control



The UNROLL compiler option instructs the compiler to perform loop unrolling, which is an optimization that replicates a loop body multiple times, and adjusts the loop control code accordingly. Loop unrolling exposes instruction level parallelism for instruction scheduling and software pipelining and thus can improve a program's performance. It also increases code size in the new loop body, which may increase pressure on register allocation, cause register spilling, and therefore cause a loss in performance. Before applying unrolling to a loop, you must evaluate these tradeoffs. In order to check if the unroll option improves performance of a particular application, you should compile your program with the usual options, run it with a representative workload, recompile it with the UNROLL option and/or unroll pragmas, and rerun it under the same conditions to see if the UNROLL option leads to a performance improvement.

The UNROLL compiler option provides the following suboptions:

- YES** Allows the compiler to unroll loops that are annotated (for example, using a pragma), unless it is overridden by **#pragma nounroll**.
- NO** Means that the compiler is not permitted to unroll loops in the compilation unit, unless **unroll** or **unroll(n)** pragmas are specified for particular loops.
- AUTO** This option is the default. It enables the compiler to unroll loops that are annotated (for example, using a pragma) and loops which the compiler has decided (via heuristics) are appropriate for unrolling. AUTO should only be specified if you have specified OPTIMIZE(2) or greater and COMPACT is not specified.

## UPCONV | NOUPCONV

**Default:** NOUPCONV

**Note:** The **cc** compiler invocation command for a regular compile in the z/OS UNIX System Services environment uses UPCONV as the default option.

| Option Scope |             |          |
|--------------|-------------|----------|
| C Compile    | C++ Compile | IPA Link |
| ✓            |             | ✓        |

**Category:** Programming Language Characteristics Control



The UPCONV option causes the z/OS XL C compiler to follow unsignedness preserving rules when doing C type conversions; that is, when widening all integral types (char, short, int, long). Use this option when compiling older C programs that depend on the *K&R C* conversion rules.

**Note:** This document uses the term *K&R C* to refer to the C language plus the generally accepted extensions produced by Brian Kernighan and Dennis Ritchie that were in use prior to the ISO standardization of C.

Whenever you specify the UPCONV compiler option, a comment noting its use will be generated in your object module to aid you in diagnosing your program.

You can specify this option using the **#pragma options** directive for C.

## WARN64 | NOWARN64

Default: NOWARN64

| Option Scope |             |          |
|--------------|-------------|----------|
| C Compile    | C++ Compile | IPA Link |
| ✓            | ✓           | ✓        |

Category: Debug/Diagnostic



The WARN64 option generates diagnostic messages for situations where compiling the source code with ILP32 and LP64 may produce different behavior. This option is designed to help migrate a program to 64-bit mode. Use the FLAG(I) option to display any informational messages.

WARN64 warns you about any code fragments that have the following types of portability errors:

- A constant that selected an unsigned long int data type in 31-bit mode may fit within a long int data type in 64-bit mode
- A constant larger than UINT\_MAX, but smaller than ULONGLONG\_MAX will overflow in 31-bit mode, but will be acceptable in an unsigned long or signed long in 64-bit mode

It also warns you about the following types of possible portability errors:

- Loss of digits when you assign a long type to an int type
- Change in the result when you assign an int to a long type
- Loss of high-order bytes of a pointer when a pointer type is assigned to an int type
- Incorrect pointer when an int type is assigned to a pointer type
- Change of a constant value when the constant is assigned to a long type

## WSIZEOF | NOWSIZEOF

Default: NOWSIZEOF

| Option Scope |             |          |
|--------------|-------------|----------|
| C Compile    | C++ Compile | IPA Link |
| ✓            | ✓           | ✓        |

Category: Object Code Control



When you use the WSIZEOF option, sizeof returns the size of the widened type for function return types instead of the size of the original return type. For example, if you compile the following program with the WSIZEOF option, the value of i is 4.

```
char foo();
i = sizeof foo();
```

C/C++ compilers prior to and including C/C++ MVS/ESA™ Version 3 Release 1 returned the size of the widened type instead of the original type for function return types.

The z/OS XL C/C++ compiler now gives `i` the value 1, which is the size of the original type `char`.

If your source code depends on the behavior of the old compilers, use the `WSIZEOF` option to return the size of widened type for function return types.

The `WSIZEOF` option has exactly the same effect as putting a **`#pragma wsizeof(on)`** at the beginning of your source file. For more information on **`#pragma wsizeof(on)`**, see *z/OS XL C/C++ Language Reference*.

## XPLINK | NOXPLINK

**Default:** NOXPLINK

For LP64, the default is XPLINK.

| Option Scope |             |          |
|--------------|-------------|----------|
| C Compile    | C++ Compile | IPA Link |
| ↙            | ↙           | ↙        |

**Category:** Object Code Control, Debug/Diagnostic

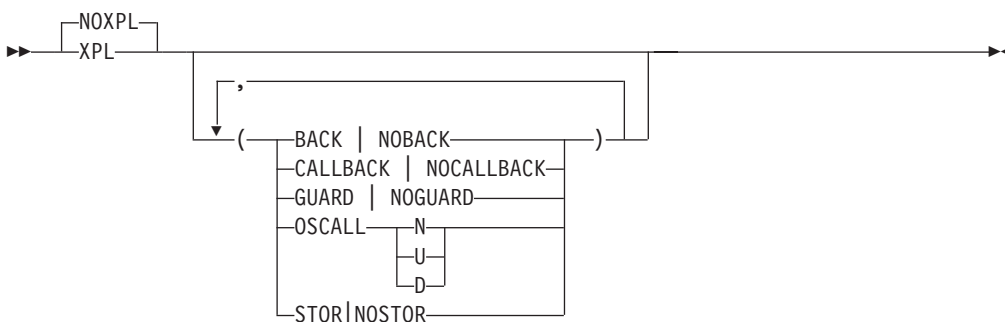

The XPLINK (Extra Performance Linkage) option instructs the compiler to generate extra performance linkage for subroutine calls. Use this option to increase the performance of your applications.

Using the XPLINK option increases the performance of C/C++ routines by reducing linkage overhead and by passing function call parameters in registers. It supports both reentrant and non-reentrant code, as well as calls to functions exported from DLLs.

The extra performance linkage resulting from XPLINK is a common linkage convention for C and C++. Therefore, it is possible for a C function pointer to reference a non-"extern C" C++ function. It is also possible for a non-"extern C" C++ function to reference a C function pointer. With this linkage, casting integers to

function pointers is the same as on other platforms such as AIX, making it easier to port applications to z/OS using the C/C++ compiler.

You can not bind XPLINK object decks together with non-XPLINK object decks, with the exception of object decks using OS\_UPSTACK or OS\_NOSTACK. XPLINK parts of an application can work with non-XPLINK parts across DLL and fetch() boundaries.

When compiling using the XPLINK option, the compiler uses the following options as defaults:

- CSECT()
- GOFF
- LONGNAME
- NORENT

You may override these options. However, the XPLINK option requires the GOFF option. If you specify the NOGOFF option, the compiler issues a warning message and promotes the option to GOFF.

In addition, the XPLINK option requires that the value of ARCH must be 2 or greater. The compiler issues a message if you specify ARCH(0) or ARCH(1) with XPLINK and forces ARCH to the default value.

**Note:** When using XPLINK and source files with duplicate file names, the linker may emit an error and discard one of the code sections. In this case, turn off the CSECT option by specifying NOCSECT.

The XPLINK option accepts the following suboptions:

BACKCHAIN | NOBACKCHAIN

DEFAULT: NOBACKCHAIN

If you specify BACKCHAIN, the compiler generates a prolog that saves information about the calling function in the stack frame of the called function. This facilitates debugging using storage dumps. Use this suboption in conjunction with STOREARGS to make storage dumps more useful.

CALLBACK | NOCALLBACK

DEFAULT: NOCALLBACK

XPLINK(CALLBACK) is primarily intended to enable function pointer calls across XPLINK DLLs and non-XPLINK programs. With XPLINK, function calls are supported across a DLL boundary with certain restrictions. In particular, if a function pointer is created by a non-XPLINK caller pointing to an XPLINK function, it can be passed as an argument via an exported function into the DLL, which can then use it as callback. This is because the compiler knows about the function pointer argument and is able to insert code to fix-up the function pointer. However, non-XPLINK function pointers passed into the DLL by other means are not supported. If you specify CALLBACK, all calls via function pointers will be considered potentially incompatible, and fix-up code will be inserted by the compiler at the locations of the incompatible DLL callbacks through function pointers to assist the call. The application will be impacted by a performance penalty. In an XPLINK(NOCALLBACK) compilation, if a function pointer is declared

using the `__callback` qualifier keyword, the compiler will insert fix-up code to assist the call. For more information on this keyword, see *z/OS XL C/C++ Language Reference*.

**Note:** In LP64 mode, the only linkage supported is XPLINK. Do not use XPLINK(CALLBACK) in LP64 mode.

#### GUARD | NOGUARD

DEFAULT: GUARD

If you specify NOGUARD, the compiler generates an explicit check for stack overflow, which enables the storage run-time option. Using NOGUARD causes a performance degradation at run time, even if you do not use the Language Environment run-time STORAGE option.

#### OSCALL(NOSTACK| UPSTACK| DOWNSTACK)

DEFAULT: NOSTACK

This suboption directs the compiler to use the linkage (OS\_NOSTACK, OS\_UPSTACK, or OS\_DOWNSTACK) as specified in this suboption for any **#pragma linkage(identifier, OS)** calls in your application.

This value causes the compiler to use the following linkage wherever linkage OS is specified by **#pragma linkage** in C, or extern "linkage" in C++:

| Linkage Used     | Linkage Specified                          |
|------------------|--|
| <b>NOSTACK</b>   | OS_NOSTACK or OS31_NOSTACK<br>(equivalent) |
| <b>UPSTACK</b>   | OS_UPSTACK                                 |
| <b>DOWNSTACK</b> | OS_DOWNSTACK                               |

For example, since the default of this option is NOSTACK, any **#pragma linkage(identifier,OS)** in C code, works just as if **#pragma linkage(identifier,OS31\_NOSTACK)** had been specified.

The abbreviated form of this suboption is OSCALL(N | U | D).

This suboption only applies to routines that are referenced but not defined in the compilation unit.

#### STOREARGS| NOSTOREARGS

DEFAULT: NOSTOREARGS

If you specify the STOREARGS suboption, the compiler generates code to store arguments that are normally only passed in registers, into the caller's argument area. This facilitates debugging using storage dumps. Use this suboption in conjunction with the BACKCHAIN suboption to make storage dumps more useful.

Note that the values in the argument area may be modified by the called function.

The abbreviated form of this suboption is STOR.

| To build a non-XPLINK C++ application, you can use the Standard C++ Library. It  
| only supports dynamic binding by linking side-decks from CEE.SCEELIB(C128N). In  
| addition, for iostream classes, you can either link the USL iostream Class Library

objects from CBC.SCLBCPP or use the side-deck from CBC.SCLBSID(IOSTREAM) for the DLL version. If you are using USL iostream classes, you must ensure that the iostream header files are resolved from CEE.SCEEH.H.

To get the proper data set allocation at prelink/link time, the following **c++** or **cxx** environment variables, if exported, should include the concatenations listed below. If they are unset, these variables take the default values which already include the required concatenations.

#### For static binding with USL iostream objects:

- `_CXX_PSYSIX="{_CXX_PLIB_PREFIX}.SCEELIB(C128N)"`
- `_CXX_PSYSLIB="{_CXX_PLIB_PREFIX}.SCEE OBJ:{_CXX_PLIB_PREFIX}.SCEECPP:{_CXX_CLASSLIB_PREFIX}.SCLBCPP"`
- `_CXX_LSYSLIB="{_CXX_PLIB_PREFIX}.SCEELKEX:{_CXX_PLIB_PREFIX}.SCEELKED"`

#### For USL iostream DLL:

- `_CXX_PSYSIX="{_CXX_CLASSLIB_PREFIX}.SCLBSID(IOSTREAM):{_CXX_PLIB_PREFIX}.SCEELIB(C128N)"`
- `_CXX_PSYSLIB="{_CXX_PLIB_PREFIX}.SCEE OBJ:{_CXX_PLIB_PREFIX}.SCEECPP"`
- `_CXX_LSYSLIB="{_CXX_PLIB_PREFIX}.SCEELKEX:{_CXX_PLIB_PREFIX}.SCEELKED"`

#### For building without USL iostream DLL:

- `_CXX_PSYSIX="{_CXX_PLIB_PREFIX}.SCEELIB(C128N)"`
- `_CXX_PSYSLIB="{_CXX_PLIB_PREFIX}.SCEE OBJ:{_CXX_PLIB_PREFIX}.SCEECPP"`
- `_CXX_LSYSLIB="{_CXX_PLIB_PREFIX}.SCEELKEX:{_CXX_PLIB_PREFIX}.SCEELKED"`

### Effect on IPA Compile step

The IPA Compile step generates information for the IPA Link step. The IPA information in an IPA object file is always generated using the XOBJ format.

This option affects the IPA optimized object module that is generated by specifying the IPA(OBJONLY) option. The object format used to encode this object depends on the GOFF option.

The XPLINK option also affects the regular object module if you request one by specifying the IPA(OBJECT) option. The object format used to encode the regular object depends on the GOFF option.

### Effect on IPA Link step

The IPA Link step accepts the XPLINK option, but ignores it. This is because the linkage convention for a particular subprogram is set during source analysis based on the compile options and #pragmas. It is not possible to change this during the IPA Link step.

The IPA Link step links and merges the application code. All symbol definition and references are checked for compatible attributes, and subprogram calls are checked for compatible linkage conventions. If incompatibilities are found, a diagnostic message is issued and processing is terminated.

The IPA Link step next optimizes the application code, and then divides it into sections for code generation. Each of these sections is a partition. The IPA Link step uses information from the IPA Compile step to determine if a subprogram can be placed in a particular partition. Only compatible subprograms are included in a given partition.

The value of the XPLINK option for a partition is set to the value of the first subprogram that is placed in the partition. The partition map sections of the IPA Link step listing and the object module display the value of the XPLINK option.

Partitions with the XPLINK option are always generated with the GOFF option.

## XREF | NOXREF

**Default:** NOXREF

In the z/OS UNIX System Services environment, this option is turned on by specifying `-V` when using the `c89`, `cc`, or `c++` commands.

| Option Scope |             |          |
|--------------|-------------|----------|
| C Compile    | C++ Compile | IPA Link |
| ✓            | ✓           | ✓        |

**Category:** Listing



The XREF option generates a cross reference listing that shows file definition, line definition, reference, and modification information for each symbol. It also generates the External Symbol Cross Reference and Static Map.

For C, a separate offset listing of the variables will appear after the cross reference table. XREF and XREF(FULL) will generate the same output.

You can specify this option using the **#pragma options** directive for C.

### Effect on IPA Compile step

During the IPA Compile step, the compiler saves symbol storage offset information in the IPA object file as follows:

- For C, if you specify the XREF, IPA(ATTRIBUTE), or IPA(XREF) options or the **#pragma options(XREF)**
- For C++, if you specify the ATTR, XREF, IPA(ATTRIBUTE), or IPA(XREF) options

If regular object code or data is produced using the IPA(OBJECT) option, the cross reference sections of the compile listing will be controlled by the ATTR and XREF options.

### Effect on IPA Link step

If you specify the ATTR or XREF options for the IPA Link step, it generates External Symbol Cross Reference and Static Map listing sections for each partition.

The IPA Link step creates a Storage Offset listing section if during the IPA Compile step you requested the additional symbol storage offset information for your IPA objects.

---

## Using the z/OS XL C compiler listing

If you select the SOURCE or LIST option, the compiler creates a listing that contains information about the source program and the compilation. If the compilation terminates before reaching a particular stage of processing, the compiler does not generate corresponding parts of the listing. The listing contains



standard information that always appears, together with optional information that is supplied by default or specified through compiler options.

In an interactive environment you can also use the `TERMINAL` option to direct all compiler diagnostic messages to your terminal. The `TERMINAL` option directs only the diagnostic messages part of the compiler listing to your terminal.

**Note:** Although the compiler listing is for your use, it is not a programming interface and is subject to change.

## IPA considerations

The listings that the IPA Compile step produces are basically the same as those that a regular compilation produces. Any differences are noted throughout this section.

The IPA Link step listing has a separate format from the listings mentioned above. Many listing sections are similar to those that are produced by a regular compilation or the IPA Compile step with the `IPA(OBJECT)` option specified. Refer to “Using the IPA Link step listing” on page 271 for information about IPA Link step listings.

## Example of a C compiler listing

Figure 12 on page 222 shows an example of a C compiler listing.

```

          * * * * * P R O L O G * * * * *

Compile Time Library . . . . . : 41080000
Command options:
Program name. . . . . : 'TSCTEST.ZOSV1R8.SCCNSAM(CCNUAAM) '
Compiler options. . . . . : *NOGONUMBER *NOALIAS *NORENT *TERMINAL *NOUPCONV *SOURCE *LIST
                          : *XREF *AGG *NOPPONLY *NOEXPMAC *NOSHOWINC *NOOFFSET *MEMORY *NOSSCOMM
                          : *NOLONGNAME *START *EXECOPS *ARGPARSE *NOEXPORTALL *NODLL (NOCALLBACKANY)
                          : *NOLIBANSI *NOWSIZEOF *REDIR *ANSIALIAS *DIGRAPH *NOROCONST *ROSTRING
                          : *TUNE (5) *ARCH (5) *SPILL (128) *MAXMEM (2097152) *NOCOMPACT
                          : *TARGET (LE, CURRENT) *FLAG (I) *NOTEST (SYM, BLOCK, LINE, PATH, HOOK) *NOOPTIMIZE
                          : *INLINE (AUTO, REPORT, 100, 1000) *NESTINC (255) *BITFIELD (UNSIGNED)
                          : *NOCHECKOUT (NOPPTRACE, PPCHECK, GOTO, ACCURACY, PARM, NOENUM,
                          : NOEXTERN, TRUNC, INIT, NOPORT, GENERAL, CAST)
                          : *FLOAT (HEX, FOLD, AFP (NOVOLATILE)) *STRICT *NOIGNERRNO *NOINITAUTO
                          : *NOCOMPRESS *NOSTRICT_INDUCTION *AGGCOPY (NOOVERLAP) *CHARS (UNSIGNED)
                          : *NOCSECT
                          : *NOEVENTS
                          : *OBJECT
                          : *NOOPTFILE
                          : *NOSERVICE
                          : *NOOE
                          : *NOIPA
                          : *SEARCH (/'TSCTEST.CEEZ180.SCEEH.+')
                          : *NOLSEARCH
                          : *NOLOCALE *HALT (16) *PLIST (HOST)
                          : *NOCONVLIT
                          : *NOASCII
                          : *NOGOFF *ILP32 *NOWARN64 *NOHGPR (NOPRESERVE)
                          : *NOXPLINK (NOBACKCHAIN, NOSTOREARGS, NOCALLBACK, GUARD, OSCALL (NOSTACK))
                          : *ENUMSIZE (SMALL)
                          : *NOHALTONMSG
                          : *NOSUPPRESS
                          : *NODEBUG
                          : *NOSQL
                          : *NOCICS
                          : *UNROLL (AUTO)
                          : *NOHOT
Version Macros. . . . . : __COMPILER_VER__=0x41080000 __LIBREL__=0x41080000 __TARGET_LIB__=0x41080000
Language level. . . . . : *EXTENDED
Source margins. . . . . :
  Varying length. . . . . : 1 - 32760
  Fixed length. . . . . : 1 - 32760
Sequence columns. . . . . :
  Varying length. . . . . : none
  Fixed length. . . . . : none

          * * * * * E N D O F P R O L O G * * * * *

```

Figure 12. Example of a C listing (Part 1 of 33)

```

          * * * * * S O U R C E * * * * *

LINE  STMT
1      | #include <stdio.h>
2      |
3      | #include "ccnuaan.h"
4      |
5      | void convert(double);
6      |
7      | int main(int argc, char **argv)
8      | {
9      |     double c_temp;
10     |
11     | 1     if (argc == 1) { /* get Celsius value from stdin */
12     |     int ch;
13     |
14     | 2     printf("Enter Celsius temperature: \n");
15     |
16     | 3     if (scanf("%f", &c_temp) != 1) {
17     | 4     printf("You must enter a valid temperature\n");
18     |     }
19     |     else {
20     | 5     convert(c_temp);
21     |     }
22     | }
23     | else { /* convert the command-line arguments to Fahrenheit */
24     |     int i;
25     |
26     | 6     for (i = 1; i < argc; ++i) {
27     | 7     if (sscanf(argv[i], "%f", &c_temp) != 1)
28     | 8     printf("%s is not a valid temperature\n",argv[i]);
29     |     else
30     | 9     convert(c_temp);
31     |     }
32     | }
33     | 10    return 0;
34     | }
35     |
36     | void convert(double c_temp) {
37     | 11    double f_temp = (c_temp * CONV + OFFSET);
38     | 12    printf("%5.2f Celsius is %5.2f Fahrenheit\n",c_temp, f_temp);
39     | }

          * * * * * E N D   O F   S O U R C E * * * * *

```

Figure 12. Example of a C listing (Part 2 of 33)

\*\*\*\*\* INCLUDES \*\*\*\*\*

INCLUDE FILES --- FILE# NAME

```

1 TSCTEST.CEEZ180.SCEEH.H(STDIO)
2 TSCTEST.CEEZ180.SCEEH.H(FEATURES)
3 TSCTEST.CEEZ180.SCEEH.SYS.H(TYPES)
4 TSCTEST.ZOSV1R8.SCCNSAM(CCNAAAM)

```

\*\*\*\*\* END OF INCLUDES \*\*\*\*\*

\*\*\*\*\* CROSS REFERENCE LISTING \*\*\*\*\*

| IDENTIFIER            | DEFINITION | ATTRIBUTES<br><SEQNBR>-<FILE NO>:<FILE LINE NO>  |
|-----------------------|------------|--|
| __valist              | 1-1:134    | Class = typedef, Length = 8<br>Type = array[2] of pointer to unsigned char<br>1-1:137, 1-1:448, 1-1:449, 1-1:451 |
| __abend               | 1-1:876    | Type = struct with no tag in union at offset 0   |
| __alloc               | 1-1:886    | Type = struct with no tag in union at offset 0   |
| __amrc_noseek_to_seek | 1-1:919    | Type = unsigned char in struct __amrc2type at offset 232   |
| __amrc_pad            | 1-1:921    | Type = array[23] of unsigned char in struct __amrc2type at offset 233  |
| __amrc_ptr            | 1-1:928    | Class = typedef, Length = 4<br>Type = pointer to struct __amrc2type  |
| __amrc_type           | 1-1:924    | Class = typedef, Length = 256<br>Type = struct __amrc2type<br>1-1:928  |
| __amrc2type           | 1-1:858    | Class = struct tag   |
| __amrc2_ptr           | 1-1:942    | Class = typedef, Length = 4<br>Type = pointer to struct __amrc2type  |
| __amrc2_type          | 1-1:938    | Class = typedef, Length = 32<br>Type = struct __amrc2type<br>1-1:942   |
| __amrc2type           | 1-1:933    | Class = struct tag   |
| __blksize             | 1-1:710    | Type = unsigned long in struct __fileData at offset 8  |
| __bufPtr              | 1-1:70     | Type = pointer to unsigned char in struct __file at offset 0   |
| __cntlinterpret       | 1-1:75     | Type = unsigned int:1 in struct __file at offset 20(0)   |
| __code                | 1-1:887    | Type = union with no tag in struct __amrc2type at offset 0   |
| __countIn             | 1-1:71     | Type = long in struct __file at offset 4   |
| __countOut            | 1-1:72     | Type = long in struct __file at offset 8   |
| __cusp                | 1-1:193    | Class = typedef, Length = 4<br>Type = pointer to const unsigned short  |
| __device              | 1-1:709    | Type = enum with no tag in struct __fileData at offset 4   |
| __device_specific     | 1-1:726    | Type = union with no tag in struct __fileData at offset 16   |
| __device_t            | 1-1:650    | Class = typedef, Length = 1<br>Type = enum with no tag   |

Figure 12. Example of a C listing (Part 3 of 33)

```

          * * * * * C R O S S   R E F E R E N C E   L I S T I N G   * * * * *
IDENTIFIER      DEFINITION      ATTRIBUTES
<SEQNBR>-<FILE NO>:<FILE LINE NO>
1-1:709
__disk          1-1:635          Class = enumeration constant: 0, Length = 4
                                     Type = int
__disk          1-1:724          Type = struct with no tag in union at offset 0
__disk_access_method
1-1:721          Type = unsigned char in struct at offset 2
__disk_noseek_to_seek
1-1:722          Type = unsigned char in struct at offset 3
__disk_reserve  1-1:723          Type = array[2] of long in struct at offset 4
__disk_vsam_type 1-1:720          Type = unsigned short in struct at offset 0
__dsname        1-1:727          Type = pointer to unsigned char in struct __fileData at offset 28
__dsorgConcat   1-1:685          Type = unsigned int:1 in struct __fileData at offset 1(3)
__dsorgHiper    1-1:687          Type = unsigned int:1 in struct __fileData at offset 1(5)
__dsorgHFS      1-1:692          Type = unsigned int:1 in struct __fileData at offset 2(0)
__dsorgMem      1-1:686          Type = unsigned int:1 in struct __fileData at offset 1(4)
__dsorgPDSdir   1-1:683          Type = unsigned int:1 in struct __fileData at offset 1(1)
__dsorgPDSmem   1-1:682          Type = unsigned int:1 in struct __fileData at offset 1(0)
__dsorgPDSE     1-1:699          Type = unsigned int:1 in struct __fileData at offset 2(7)
__dsorgPO       1-1:681          Type = unsigned int:1 in struct __fileData at offset 0(7)
__dsorgPS       1-1:684          Type = unsigned int:1 in struct __fileData at offset 1(2)
__dsorgTemp     1-1:688          Type = unsigned int:1 in struct __fileData at offset 1(6)
__dsorgVSAM     1-1:689          Type = unsigned int:1 in struct __fileData at offset 1(7)
__dummy         1-1:640          Class = enumeration constant: 6, Length = 4
                                     Type = int
__error         1-1:870          Type = int in union at offset 0
__error2        1-1:934          Type = int in struct __amrc2type at offset 0
__fcb_ascii     1-1:76           Type = unsigned int:1 in struct __file at offset 20(1)
__fcb_orientation
1-1:77          Type = unsigned int:2 in struct __file at offset 20(2)
__fcbgetc       1-1:73          Type = pointer to function returning int in struct __file at offset 12

```

Figure 12. Example of a C listing (Part 4 of 33)

## \* \* \* \* \* C R O S S R E F E R E N C E L I S T I N G \* \* \* \* \*

| IDENTIFIER   | DEFINITION | ATTRIBUTES<br><SEQNBR>-<FILE NO>-<FILE LINE NO>  |
|--------------|------------|--|
| __fcbputc    | 1-1:74     | Type = pointer to function returning int in struct __file at offset 16                   |
| __fdbk       | 1-1:881    | Type = unsigned char in struct at offset 3   |
| __fdbk_fill  | 1-1:878    | Type = unsigned char in struct at offset 0   |
| __feedback   | 1-1:882    | Type = struct with no tag in union at offset 0   |
| __ffile      | 1-1:80     | Class = struct tag<br>1-1:85, 1-1:91   |
| __file       | 1-1:65     | Class = struct tag<br>1-1:66, 1-1:67, 1-1:82   |
| __fileptr    | 1-1:936    | Type = pointer to struct __ffile in struct __amrc2type at offset 4                       |
| __fileData   | 1-1:673    | Class = struct tag<br>1-1:731  |
| __fill       | 1-1:845    | Type = unsigned int in struct at offset 0  |
| __filler1    | 1-1:618    | Type = unsigned char in struct __S99emparms at offset 3                                  |
| __fill2      | 1-1:901    | Type = array[2] of unsigned int in struct at offset 136                                  |
| __fp         | 1-1:82     | Type = pointer to struct __file in struct __ffile at offset 0                            |
| __fpos_elem  | 1-1:96     | Type = array[8] of long in struct __fpos_t at offset 0                                   |
| __fpos_t     | 1-1:95     | Class = struct tag<br>1-1:99   |
| __ftncd      | 1-1:880    | Type = unsigned char in struct at offset 2   |
| __func__     | 36-0:36    | Class = static, Length = 8<br>Type = array[8] of const unsigned char in function convert |
| __func__     | 8-0:8      | Class = static, Length = 5<br>Type = array[5] of const unsigned char in function main    |
| __hfs        | 1-1:647    | Class = enumeration constant: 9, Length = 4<br>Type = int                                |
| __hiperspace | 1-1:648    | Class = enumeration constant: 10, Length = 4<br>Type = int                               |
| __last_op    | 1-1:894    | Type = unsigned int in struct __amrctype at offset 8                                     |
| __len        | 1-1:897    | Type = unsigned int in struct at offset 4  |
| __len_fill   | 1-1:896    | Type = unsigned int in struct at offset 0  |

Figure 12. Example of a C listing (Part 5 of 33)

```

          * * * * * C R O S S   R E F E R E N C E   L I S T I N G   * * * * *
IDENTIFIER      DEFINITION      ATTRIBUTES
<SEQNBR>-<FILE NO>:<FILE LINE NO>
__maxreclen     1-1:711          Type = unsigned long in struct __fileData at offset 12
__memory        1-1:646          Class = enumeration constant: 8, Length = 4
                                     Type = int
__modeflag      1-1:698          Type = unsigned int:4 in struct __fileData at offset 2(3)
__msg           1-1:904          Type = struct with no tag in struct __amrctype at offset 12
__msgfile       1-1:643          Class = enumeration constant: 7, Length = 4
                                     Type = int
__openmode      1-1:697          Type = unsigned int:2 in struct __fileData at offset 2(1)
__other         1-1:649          Class = enumeration constant: 255, Length = 4
                                     Type = int
__parmr0        1-1:899          Type = unsigned int in struct at offset 128
__parmr1        1-1:900          Type = unsigned int in struct at offset 132
__printer       1-1:637          Class = enumeration constant: 2, Length = 4
                                     Type = int
__rc            1-1:875          Type = unsigned short in struct at offset 2
__rc            1-1:879          Type = unsigned char in struct at offset 1
__recfmASA      1-1:679          Type = unsigned int:1 in struct __fileData at offset 0(5)
__recfmBlk      1-1:678          Type = unsigned int:1 in struct __fileData at offset 0(4)
__recfmF        1-1:674          Type = unsigned int:1 in struct __fileData at offset 0(0)
__recfmM        1-1:680          Type = unsigned int:1 in struct __fileData at offset 0(6)
__recfmS        1-1:677          Type = unsigned int:1 in struct __fileData at offset 0(3)
__recfmU        1-1:676          Type = unsigned int:1 in struct __fileData at offset 0(2)
__recfmV        1-1:675          Type = unsigned int:1 in struct __fileData at offset 0(1)
__recnum        1-1:846          Type = unsigned int in struct at offset 4
__reserved      1-1:601          Type = unsigned char in struct __S99rbx at offset 16
__reserved      1-1:937          Type = array[6] of int in struct __amrc2type at offset 8
__reserve2      1-1:704          Type = unsigned int:4 in struct __fileData at offset 3(4)
__reserve4      1-1:728          Type = pointer to void in struct __fileData at offset 32
__reserv1       1-1:623          Type = int in struct __S99emparms at offset 20

```

Figure 12. Example of a C listing (Part 6 of 33)

## \* \* \* \* \* C R O S S R E F E R E N C E L I S T I N G \* \* \* \* \*

| IDENTIFIER      | DEFINITION | ATTRIBUTES<br><SEQNBR>-<FILE NO>-<FILE LINE NO>                     |
|-----------------|------------|---|
| __reserv2       | 1-1:609    | Type = int in struct __S99rbx at offset 32                          |
| __reserv2       | 1-1:624    | Type = int in struct __S99emparms at offset 24                      |
| __rplfdbwd      | 1-1:907    | Type = array[4] of unsigned char in struct __amrctype at offset 220 |
| __rrds_key_type | 1-1:851    | Class = typedef, Length = 8<br>Type = struct with no tag            |
| __str           | 1-1:898    | Type = array[120] of unsigned char in struct at offset 8            |
| __str2          | 1-1:902    | Type = array[64] of unsigned char in struct at offset 144           |
| __svc99_error   | 1-1:885    | Type = unsigned short in struct at offset 2                         |
| __svc99_info    | 1-1:884    | Type = unsigned short in struct at offset 0                         |
| __syscode       | 1-1:874    | Type = unsigned short in struct at offset 0                         |
| __tape          | 1-1:638    | Class = enumeration constant: 3, Length = 4<br>Type = int           |
| __tdq           | 1-1:639    | Class = enumeration constant: 5, Length = 4<br>Type = int           |
| __terminal      | 1-1:636    | Class = enumeration constant: 1, Length = 4<br>Type = int           |
| __vsam          | 1-1:717    | Type = struct with no tag in union at offset 0                      |
| __vsam_keylen   | 1-1:715    | Type = unsigned long in struct at offset 4                          |
| __vsam_type     | 1-1:714    | Type = unsigned short in struct at offset 0                         |
| __vsam_RKP      | 1-1:716    | Type = unsigned long in struct at offset 8                          |
| __vsamEA        | 1-1:703    | Type = unsigned int:1 in struct __fileData at offset 3(3)           |
| __vsamRLS       | 1-1:701    | Type = unsigned int:3 in struct __fileData at offset 3(0)           |
| __EMBUFP        | 1-1:622    | Type = pointer to void in struct __S99emparms at offset 16          |
| __EMCPPLP       | 1-1:621    | Type = pointer to void in struct __S99emparms at offset 12          |
| __EMFUNCT       | 1-1:615    | Type = unsigned char in struct __S99emparms at offset 0             |
| __EMIDNUM       | 1-1:616    | Type = unsigned char in struct __S99emparms at offset 1             |
| __EMNMSGBK      | 1-1:617    | Type = unsigned char in struct __S99emparms at offset 2             |
| __EMRETCOD      | 1-1:620    | Type = int in struct __S99emparms at offset 8                       |

Figure 12. Example of a C listing (Part 7 of 33)



```

          * * * * * C R O S S   R E F E R E N C E   L I S T I N G   * * * * *
IDENTIFIER      DEFINITION      ATTRIBUTES
<SEQNBR>-<FILE NO>-<FILE LINE NO>

__EMS99RBP      1-1:619          Type = pointer to void in struct __S99emparms at offset 4
__FILEP         1-1:85           Class = typedef, Length = 4
                                     Type = pointer to struct __ffile
__RBA           1-1:888          Type = unsigned int in struct __amrctype at offset 4
__S99emparms    1-1:614          Class = struct tag
                                     1-1:627
__S99emparms_t  1-1:627          Class = typedef, Length = 28
                                     Type = struct __S99emparms
__S99parms      1-1:587          Class = typedef, Length = 20
                                     Type = struct __S99struc
                                     1-1:814
__S99rbx        1-1:591          Class = struct tag
                                     1-1:612
__S99rbx_t      1-1:612          Class = typedef, Length = 36
                                     Type = struct __S99rbx
__S99struc      1-1:570          Class = struct tag
                                     1-1:587
__S99ECPPL      1-1:600          Type = pointer to void in struct __S99rbx at offset 12
__S99EERR       1-1:607          Type = unsigned short in struct __S99rbx at offset 28
__S99EID        1-1:593          Type = array[6] of unsigned char in struct __S99rbx at offset 0
__S99EINFO      1-1:608          Type = unsigned short in struct __S99rbx at offset 30
__S99EKEY       1-1:597          Type = unsigned char in struct __S99rbx at offset 9
__S99EMGSV      1-1:598          Type = unsigned char in struct __S99rbx at offset 10
__S99EMSGP      1-1:606          Type = pointer to void in struct __S99rbx at offset 24
__S99ENMSG      1-1:599          Type = unsigned char in struct __S99rbx at offset 11
__S99EOPTS      1-1:595          Type = unsigned char in struct __S99rbx at offset 7
__S99ERCF       1-1:604          Type = unsigned char in struct __S99rbx at offset 19
__S99ERCO       1-1:603          Type = unsigned char in struct __S99rbx at offset 18
__S99ERES       1-1:602          Type = unsigned char in struct __S99rbx at offset 17
__S99ERROR      1-1:576          Type = unsigned short in struct __S99struc at offset 4
__S99ESUBP      1-1:596          Type = unsigned char in struct __S99rbx at offset 8

```

Figure 12. Example of a C listing (Part 8 of 33)

```

          * * * * * C R O S S   R E F E R E N C E   L I S T I N G   * * * * *
IDENTIFIER      DEFINITION      ATTRIBUTES
<SEQNBR>-<FILE NO>:<FILE LINE NO>

__S99EVER      1-1:594          Type = unsigned char in struct __S99rbx at offset 6
__S99EWRC      1-1:605          Type = int in struct __S99rbx at offset 20
__S99FLAG1     1-1:574          Type = unsigned short in struct __S99struc at offset 2
__S99FLAG2     1-1:582          Type = unsigned int in struct __S99struc at offset 16
__S99INFO      1-1:577          Type = unsigned short in struct __S99struc at offset 6
__S99RBLN      1-1:572          Type = unsigned char in struct __S99struc at offset 0
__S99S99X      1-1:580          Type = pointer to void in struct __S99struc at offset 12
__S99TXTP      1-1:578          Type = pointer to void in struct __S99struc at offset 8
__S99VERB      1-1:573          Type = unsigned char in struct __S99struc at offset 1
__XRBA         1-1:913          Type = unsigned long long in struct __amrctype at offset 224
_gtca          Class = extern
              Type = function returning pointer to const void
              1-1:158
_gtab          Class = extern
              Type = function returning pointer to pointer to void
              1-1:148
_GETCFUNC      1-1:66           Class = typedef
              Type = function returning int
              1-1:73
_PUTCFUNC      1-1:67           Class = typedef
              Type = function returning int
              1-1:74
argc           7-0:7           Class = parameter, Length = 4
              Type = int in function main
              11-0:11, 26-0:26, 26-0:26
argv           7-0:7           Class = parameter, Length = 4
              Type = pointer to pointer to unsigned char in function main
              27-0:27, 28-0:28
c_temp        36-0:36          Class = parameter, Length = 8
              Type = double in function convert
              37-0:37, 38-0:38
c_temp        9-0:9           Class = auto, Length = 8
              Type = double in function main
              16-0:16, 20-0:20, 27-0:27, 30-0:30

```

Figure 12. Example of a C listing (Part 9 of 33)

```

***** CROSS REFERENCE LISTING *****
IDENTIFIER      DEFINITION      ATTRIBUTES
<SEQNBR>-<FILE NO>:<FILE LINE NO>
ch              12-0:12        Class = auto, Length = 4
                Type = int in function main
clearerr        Class = extern
                Type = function returning void
                1-1:398
clrmemf         Class = extern
                Type = function returning int
                1-1:818
convert         36-0:36        Class = extern
                Type = function returning void
                5-0:5, 20-0:20, 30-0:30
f_temp          37-0:37        Class = auto, Length = 8
                Type = double in function convert
                37-0:37, 38-0:38
fclose          Class = extern
                Type = function returning int
                1-1:399
fdelrec         Class = extern
                Type = function returning int
                1-1:816
feof            Class = extern
                Type = function returning int
                1-1:400
ferror          Class = extern
                Type = function returning int
                1-1:401
fflush          Class = extern
                Type = function returning int
                1-1:402
fgetc           Class = extern
                Type = function returning int
                1-1:403
fgetpos         Class = extern
                Type = function returning int
                1-1:404
fgets           Class = extern
                Type = function returning pointer to unsigned char
                1-1:405
fldata          Class = extern
                Type = function returning int

```

Figure 12. Example of a C listing (Part 10 of 33)

```

***** CROSS REFERENCE LISTING *****
IDENTIFIER      DEFINITION      ATTRIBUTES
<SEQNBR>-<FILE NO>:<FILE LINE NO>
1-1:819
fldata_t        1-1:731        Class = typedef, Length = 36
                Type = struct __fileData
                1-1:819
flocate         Class = extern
                Type = function returning int
                1-1:815
fopen           Class = extern
                Type = function returning pointer to struct __file
                1-1:406
fpos_t          1-1:99        Class = typedef, Length = 32
                Type = struct __fpos_t
                1-1:404, 1-1:419
fprintf         Class = extern
                Type = function returning int
                1-1:408
fputc           Class = extern
                Type = function returning int
                1-1:410
fputs           Class = extern
                Type = function returning int
                1-1:411
fread           Class = extern
                Type = function returning unsigned int
                1-1:412
freopen         Class = extern
                Type = function returning pointer to struct __file
                1-1:414
fscanf         Class = extern
                Type = function returning int
                1-1:416
fseek           Class = extern
                Type = function returning int
                1-1:418
fsetpos         Class = extern
                Type = function returning int
                1-1:419
ftell           Class = extern
                Type = function returning long
                1-1:420

```

Figure 12. Example of a C listing (Part 11 of 33)

```

* * * * * C R O S S   R E F E R E N C E   L I S T I N G   * * * * *

IDENTIFIER      DEFINITION      ATTRIBUTES
<SEQNBR>-<FILE NO>:<FILE LINE NO>

fupdate         Class = extern
                Type = function returning unsigned int
                1-1:817

fwrite          Class = extern
                Type = function returning unsigned int
                1-1:421

getc            Class = extern
                Type = function returning int
                1-1:423

getchar         Class = extern
                Type = function returning int
                1-1:424

gets            Class = extern
                Type = function returning pointer to unsigned char
                1-1:425

i                24-0:24      Class = auto, Length = 4
                Type = int in function main
                26-0:26, 26-0:26, 27-0:27, 28-0:28, 26-0:26, 26-0:26, 26-0:26

main            7-0:7         Class = extern
                Type = function returning int

perror          Class = extern
                Type = function returning void
                1-1:426

printf          Class = extern
                Type = function returning int
                1-1:427, 14-0:14, 17-0:17, 28-0:28, 38-0:38

putc            Class = extern
                Type = function returning int
                1-1:428

putchar         Class = extern
                Type = function returning int
                1-1:429

puts            Class = extern
                Type = function returning int
                1-1:430

remove          Class = extern
                Type = function returning int
                1-1:431

rename          Class = extern

```

Figure 12. Example of a C listing (Part 12 of 33)

```

* * * * * C R O S S   R E F E R E N C E   L I S T I N G   * * * * *

IDENTIFIER      DEFINITION      ATTRIBUTES
<SEQNBR>-<FILE NO>-<FILE LINE NO>

                                Type = function returning int
                                1-1:432

rewind          Class = extern
                Type = function returning void
                1-1:433

scanf          Class = extern
                Type = function returning int
                1-1:434, 16-0:16

setbuf         Class = extern
                Type = function returning void
                1-1:435

setvbuf        Class = extern
                Type = function returning int
                1-1:436

size_t         1-1:50           Class = typedef, Length = 4
                Type = unsigned int
                1-1:412, 1-1:412, 1-1:413, 1-1:421, 1-1:421, 1-1:421, 1-1:437, 1-1:815, 1-1:817, 1-1:817

sprintf        Class = extern
                Type = function returning int
                1-1:439

sscanf        Class = extern
                Type = function returning int
                1-1:442, 27-0:27

ssize_t        1-1:59           Class = typedef, Length = 4
                Type = int

svc99          Class = extern
                Type = function returning int
                1-1:814

tmpfile        Class = extern
                Type = function returning pointer to struct __ffile
                1-1:444

tmpnam         Class = extern
                Type = function returning pointer to unsigned char
                1-1:445

ungetc        Class = extern
                Type = function returning int
                1-1:446

va_list        1-1:137         Class = typedef, Length = 8
                Type = array[2] of pointer to unsigned char

```

Figure 12. Example of a C listing (Part 13 of 33)

```

***** CROSS REFERENCE LISTING *****
IDENTIFIER      DEFINITION      ATTRIBUTES
                  <SEQNBR>-<FILE NO>-<FILE LINE NO>
vfprintf        Class = extern
                  Type = function returning int
                  1-1:447
vprintf         Class = extern
                  Type = function returning int
                  1-1:449
vsprintf        Class = extern
                  Type = function returning int
                  1-1:450
FILE            1-1:91      Class = typedef, Length = 4
                  Type = struct __ffile
                  1-1:398, 1-1:399, 1-1:400, 1-1:401, 1-1:402, 1-1:402, 1-1:403, 1-1:404, 1-1:405, 1-1:406, 1-1:408,
                  1-1:410, 1-1:411, 1-1:413, 1-1:414, 1-1:415, 1-1:416, 1-1:418, 1-1:419, 1-1:420, 1-1:422,
                  1-1:423, 1-1:428, 1-1:433, 1-1:435, 1-1:436, 1-1:444, 1-1:446, 1-1:447, 1-1:815, 1-1:816,
                  1-1:817, 1-1:819, 1-1:936
***** END OF CROSS REFERENCE LISTING *****

```

Figure 12. Example of a C listing (Part 14 of 33)

## \*\*\*\*\* STRUCTURE MAPS \*\*\*\*\*

| Aggregate map for: union with no tag #1  |                       |                       | Total size: 12 bytes |
|--|-----------------------|-----------------------|----------------------|
| .....                                    |                       |                       |                      |
| _device_specific                         |                       |                       |                      |
| .....                                    |                       |                       |                      |
| Offset<br>Bytes(Bits)                    | Length<br>Bytes(Bits) | Member Name           |                      |
| .....                                    |                       |                       |                      |
| 0  | 12                    | __vsam                |                      |
| 0  | 2                     | __vsam_type           |                      |
| 2  | 2                     | ***PADDING***         |                      |
| 4  | 4                     | __vsam_keylen         |                      |
| 8  | 4                     | __vsam_RKP            |                      |
| 0  | 12                    | __disk                |                      |
| 0  | 2                     | __disk_vsam_type      |                      |
| 2  | 1                     | __disk_access_method  |                      |
| 3  | 1                     | __disk_noseek_to_seek |                      |
| 4  | 8                     | __disk_reserve[2]     |                      |
| .....                                    |                       |                       |                      |
| Aggregate map for: struct with no tag #2 |                       |                       | Total size: 12 bytes |
| .....                                    |                       |                       |                      |
| _vsam                                    |                       |                       |                      |
| .....                                    |                       |                       |                      |
| Offset<br>Bytes(Bits)                    | Length<br>Bytes(Bits) | Member Name           |                      |
| .....                                    |                       |                       |                      |
| 0  | 2                     | __vsam_type           |                      |
| 2  | 2                     | ***PADDING***         |                      |
| 4  | 4                     | __vsam_keylen         |                      |
| 8  | 4                     | __vsam_RKP            |                      |
| .....                                    |                       |                       |                      |
| Aggregate map for: struct with no tag #3 |                       |                       | Total size: 12 bytes |
| .....                                    |                       |                       |                      |
| __disk                                   |                       |                       |                      |
| .....                                    |                       |                       |                      |
| Offset<br>Bytes(Bits)                    | Length<br>Bytes(Bits) | Member Name           |                      |
| .....                                    |                       |                       |                      |
| 0  | 2                     | __disk_vsam_type      |                      |
| 2  | 1                     | __disk_access_method  |                      |
| 3  | 1                     | __disk_noseek_to_seek |                      |
| 4  | 8                     | __disk_reserve[2]     |                      |
| .....                                    |                       |                       |                      |
| Aggregate map for: struct with no tag #4 |                       |                       | Total size: 8 bytes  |
| .....                                    |                       |                       |                      |
| __rrds_key_type                          |                       |                       |                      |
| .....                                    |                       |                       |                      |
| Offset<br>Bytes(Bits)                    | Length<br>Bytes(Bits) | Member Name           |                      |
| .....                                    |                       |                       |                      |

Figure 12. Example of a C listing (Part 15 of 33)



```

***** STRUCTURE MAPS *****
=====
| 0 | 4 | |__fill|
| 4 | 4 | |__recnum|
|-----|
Aggregate map for: _Packed struct with no tag #4 Total size: 8 bytes
.....
|_Packed __rrds_key_type
=====
| Offset | Length | Member Name |
| Bytes(Bits) | Bytes(Bits) | |
|-----|-----|-----|
| 0 | 4 | |__fill|
| 4 | 4 | |__recnum|
|-----|-----|-----|
Aggregate map for: union with no tag #5 Total size: 4 bytes
.....
|_code
=====
| Offset | Length | Member Name |
| Bytes(Bits) | Bytes(Bits) | |
|-----|-----|-----|
| 0 | 4 | |__error|
| 0 | 4 | |__abend|
| 0 | 2 | |__syscode|
| 2 | 2 | |__rc|
| 0 | 4 | |__feedback|
| 0 | 1 | |__fdbk_fill|
| 1 | 1 | |__rc|
| 2 | 1 | |__ftncd|
| 3 | 1 | |__fdbk|
| 0 | 4 | |__alloc|
| 0 | 2 | |__svc99_info|
| 2 | 2 | |__svc99_error|
|-----|-----|-----|
Aggregate map for: struct with no tag #6 Total size: 4 bytes
.....
|_abend
=====
| Offset | Length | Member Name |
| Bytes(Bits) | Bytes(Bits) | |
|-----|-----|-----|
| 0 | 2 | |__syscode|
| 2 | 2 | |__rc|
|-----|-----|-----|

```

Figure 12. Example of a C listing (Part 16 of 33)

## \*\*\*\*\* STRUCTURE MAPS \*\*\*\*\*

| Aggregate map for: struct with no tag #7 |                       |               | Total size: 4 bytes   |
|--|-----------------------|---------------|-----------------------|
| .....<br>__feedback                      |                       |               |                       |
| Offset<br>Bytes(Bits)                    | Length<br>Bytes(Bits) | Member Name   |                       |
| 0  | 1                     | __fdbk_fill   |                       |
| 1  | 1                     | __rc          |                       |
| 2  | 1                     | __ftncd       |                       |
| 3  | 1                     | __fdbk        |                       |
| .....                                    |                       |               |                       |
| Aggregate map for: struct with no tag #8 |                       |               | Total size: 4 bytes   |
| .....<br>__alloc                         |                       |               |                       |
| Offset<br>Bytes(Bits)                    | Length<br>Bytes(Bits) | Member Name   |                       |
| 0  | 2                     | __svc99_info  |                       |
| 2  | 2                     | __svc99_error |                       |
| .....                                    |                       |               |                       |
| Aggregate map for: struct with no tag #9 |                       |               | Total size: 208 bytes |
| .....<br>__msg                           |                       |               |                       |
| Offset<br>Bytes(Bits)                    | Length<br>Bytes(Bits) | Member Name   |                       |
| 0  | 4                     | __len_fill    |                       |
| 4  | 4                     | __len         |                       |
| 8  | 120                   | __str[120]    |                       |
| 128                                      | 4                     | __parmr0      |                       |
| 132                                      | 4                     | __parmr1      |                       |
| 136                                      | 8                     | __fill2[2]    |                       |
| 144                                      | 64                    | __str2[64]    |                       |
| .....                                    |                       |               |                       |
| Aggregate map for: struct __amrc_type    |                       |               | Total size: 256 bytes |
| .....<br>__amrc_type<br>*__amrc_ptr      |                       |               |                       |
| Offset<br>Bytes(Bits)                    | Length<br>Bytes(Bits) | Member Name   |                       |
| 0  | 4                     | __code        |                       |
| 0  | 4                     | __error       |                       |
| 0  | 4                     | __abend       |                       |
| .....                                    |                       |               |                       |

Figure 12. Example of a C listing (Part 17 of 33)

```

***** STRUCTURE MAPS *****

```

|     |     |                       |
|-----|-----|-----------------------|
| 0   | 2   | __syscode             |
| 2   | 2   | __rc                  |
| 0   | 4   | __feedback            |
| 0   | 1   | __fdbk_fill           |
| 1   | 1   | __rc                  |
| 2   | 1   | __ftncd               |
| 3   | 1   | __fdbk                |
| 0   | 4   | __alloc               |
| 0   | 2   | __svc99_info          |
| 2   | 2   | __svc99_error         |
| 4   | 4   | __RBA                 |
| 8   | 4   | __last_op             |
| 12  | 208 | __msg                 |
| 12  | 4   | __len_fill            |
| 16  | 4   | __len                 |
| 20  | 120 | __str[120]            |
| 140 | 4   | __parmr0              |
| 144 | 4   | __parmr1              |
| 148 | 8   | __fill2[2]            |
| 156 | 64  | __str2[64]            |
| 220 | 4   | __rplfdbwd[4]         |
| 224 | 8   | __XRBA                |
| 232 | 1   | __amrc_noseek_to_seek |
| 233 | 23  | __amrc_pad[23]        |

```

=====
Aggregate map for: _Packed struct __amrc_type                               Total size: 256 bytes
=====
_Packed __amrc_type
=====

```

| Offset<br>Bytes(Bits) | Length<br>Bytes(Bits) | Member Name   |
|-----------------------|-----------------------|---------------|
| 0                     | 4                     | __code        |
| 0                     | 4                     | __error       |
| 0                     | 4                     | __abend       |
| 0                     | 2                     | __syscode     |
| 2                     | 2                     | __rc          |
| 0                     | 4                     | __feedback    |
| 0                     | 1                     | __fdbk_fill   |
| 1                     | 1                     | __rc          |
| 2                     | 1                     | __ftncd       |
| 3                     | 1                     | __fdbk        |
| 0                     | 4                     | __alloc       |
| 0                     | 2                     | __svc99_info  |
| 2                     | 2                     | __svc99_error |
| 4                     | 4                     | __RBA         |
| 8                     | 4                     | __last_op     |
| 12                    | 208                   | __msg         |
| 12                    | 4                     | __len_fill    |
| 16                    | 4                     | __len         |
| 20                    | 120                   | __str[120]    |
| 140                   | 4                     | __parmr0      |
| 144                   | 4                     | __parmr1      |
| 148                   | 8                     | __fill2[2]    |

Figure 12. Example of a C listing (Part 18 of 33)

```

***** STRUCTURE MAPS *****

```

|     |    |                       |
|-----|----|-----------------------|
| 156 | 64 | __str2[64]            |
| 220 | 4  | __rp1fdbwd[4]         |
| 224 | 8  | __XRBA                |
| 232 | 1  | __amrc_noseek to_seek |
| 233 | 23 | __amrc_pad[23]        |

---

```

Aggregate map for: struct __amrc2type Total size: 32 bytes
.....
__amrc2_type
*__amrc2_ptr
.....

```

| Offset<br>Bytes(Bits) | Length<br>Bytes(Bits) | Member Name   |
|-----------------------|-----------------------|---------------|
| 0                     | 4                     | __error2      |
| 4                     | 4                     | __fileptr     |
| 8                     | 24                    | __reserved[6] |

---

```

Aggregate map for: _Packed struct __amrc2type Total size: 32 bytes
.....
_Packed __amrc2_type
.....

```

| Offset<br>Bytes(Bits) | Length<br>Bytes(Bits) | Member Name   |
|-----------------------|-----------------------|---------------|
| 0                     | 4                     | __error2      |
| 4                     | 4                     | __fileptr     |
| 8                     | 24                    | __reserved[6] |

---

```

Aggregate map for: struct __ffile Total size: 4 bytes
.....
*__FILEP
__FILE
.....

```

| Offset<br>Bytes(Bits) | Length<br>Bytes(Bits) | Member Name |
|-----------------------|-----------------------|-------------|
| 0                     | 4                     | __fp        |

---

```

Aggregate map for: _Packed struct __ffile Total size: 4 bytes
.....
_Packed __FILE
.....

```

| Offset<br>Bytes(Bits) | Length<br>Bytes(Bits) | Member Name |
|-----------------------|-----------------------|-------------|
| 0                     | 4                     | __fp        |

Figure 12. Example of a C listing (Part 19 of 33)

## \*\*\*\*\* STRUCTURE MAPS \*\*\*\*\*

| Aggregate map for: struct __file |                       |                   | Total size: 24 bytes |
|----------------------------------|-----------------------|-------------------|----------------------|
| Offset<br>Bytes(Bits)            | Length<br>Bytes(Bits) | Member Name       |                      |
| 0                                | 4                     | __bufPtr          |                      |
| 4                                | 4                     | __countIn         |                      |
| 8                                | 4                     | __countOut        |                      |
| 12                               | 4                     | __fcbgetc         |                      |
| 16                               | 4                     | __fcbputc         |                      |
| 20                               | 0(1)                  | __cntlinterpret   |                      |
| 20(1)                            | 0(1)                  | __fcb_ascii       |                      |
| 20(2)                            | 0(2)                  | __fcb_orientation |                      |
| 20(4)                            | 3(4)                  | ***PADDING***     |                      |

| Aggregate map for: _Packed struct __file |                       |                   | Total size: 21 bytes |
|--|-----------------------|-------------------|----------------------|
| Offset<br>Bytes(Bits)                    | Length<br>Bytes(Bits) | Member Name       |                      |
| 0  | 4                     | __bufPtr          |                      |
| 4  | 4                     | __countIn         |                      |
| 8  | 4                     | __countOut        |                      |
| 12                                       | 4                     | __fcbgetc         |                      |
| 16                                       | 4                     | __fcbputc         |                      |
| 20                                       | 0(1)                  | __cntlinterpret   |                      |
| 20(1)                                    | 0(1)                  | __fcb_ascii       |                      |
| 20(2)                                    | 0(2)                  | __fcb_orientation |                      |
| 20(4)                                    | 0(4)                  | ***PADDING***     |                      |

| Aggregate map for: struct __fileData |                       |               | Total size: 36 bytes |
|--------------------------------------|-----------------------|---------------|----------------------|
| Offset<br>Bytes(Bits)                | Length<br>Bytes(Bits) | Member Name   |                      |
| fldata_t                             |                       |               |                      |
| 0                                    | 0(1)                  | __recfmF      |                      |
| 0(1)                                 | 0(1)                  | __recfmV      |                      |
| 0(2)                                 | 0(1)                  | __recfmU      |                      |
| 0(3)                                 | 0(1)                  | __recfmS      |                      |
| 0(4)                                 | 0(1)                  | __recfmBlk    |                      |
| 0(5)                                 | 0(1)                  | __recfmASA    |                      |
| 0(6)                                 | 0(1)                  | __recfmM      |                      |
| 0(7)                                 | 0(1)                  | __dsorgPO     |                      |
| 1                                    | 0(1)                  | __dsorgPDSmem |                      |
| 1(1)                                 | 0(1)                  | __dsorgPDSdir |                      |
| 1(2)                                 | 0(1)                  | __dsorgPS     |                      |
| 1(3)                                 | 0(1)                  | __dsorgConcat |                      |
| 1(4)                                 | 0(1)                  | __dsorgMem    |                      |

Figure 12. Example of a C listing (Part 20 of 33)

```

***** STRUCTURE MAPS *****

```

|      |      |                       |
|------|------|-----------------------|
| 1(5) | 0(1) | __dsorgHiper          |
| 1(6) | 0(1) | __dsorgTemp           |
| 1(7) | 0(1) | __dsorgVSAM           |
| 2    | 0(1) | __dsorgHFS            |
| 2(1) | 0(2) | __openmode            |
| 2(3) | 0(4) | __modeflag            |
| 2(7) | 0(1) | __dsorgPDSE           |
| 3    | 0(3) | __vsamRLS             |
| 3(3) | 0(1) | __vsamEA              |
| 3(4) | 0(4) | __reserve2            |
| 4    | 1    | __device              |
| 5    | 3    | ***PADDING***         |
| 8    | 4    | __blksize             |
| 12   | 4    | __maxreclen           |
| 16   | 12   | __device_specific     |
| 16   | 12   | __vsam                |
| 16   | 2    | __vsam_type           |
| 18   | 2    | ***PADDING***         |
| 20   | 4    | __vsam_keylen         |
| 24   | 4    | __vsam_RKP            |
| 16   | 12   | __disk                |
| 16   | 2    | __disk_vsam_type      |
| 18   | 1    | __disk_access_method  |
| 19   | 1    | __disk_noseek_to_seek |
| 20   | 8    | __disk_reserve[2]     |
| 28   | 4    | __dsname              |
| 32   | 4    | __reserve4            |

---

Aggregate map for: \_\_Packed struct \_\_fileData Total size: 33 bytes

.....  
 \_\_Packed fldata\_t  
 .....

| Offset<br>Bytes(Bits) | Length<br>Bytes(Bits) | Member Name   |
|-----------------------|-----------------------|---------------|
| 0                     | 0(1)                  | __recfmF      |
| 0(1)                  | 0(1)                  | __recfmV      |
| 0(2)                  | 0(1)                  | __recfmU      |
| 0(3)                  | 0(1)                  | __recfmS      |
| 0(4)                  | 0(1)                  | __recfmBlk    |
| 0(5)                  | 0(1)                  | __recfmASA    |
| 0(6)                  | 0(1)                  | __recfmM      |
| 0(7)                  | 0(1)                  | __dsorgPO     |
| 1                     | 0(1)                  | __dsorgPDSmem |
| 1(1)                  | 0(1)                  | __dsorgPDSdir |
| 1(2)                  | 0(1)                  | __dsorgPS     |
| 1(3)                  | 0(1)                  | __dsorgConcat |
| 1(4)                  | 0(1)                  | __dsorgMem    |
| 1(5)                  | 0(1)                  | __dsorgHiper  |
| 1(6)                  | 0(1)                  | __dsorgTemp   |
| 1(7)                  | 0(1)                  | __dsorgVSAM   |
| 2                     | 0(1)                  | __dsorgHFS    |
| 2(1)                  | 0(2)                  | __openmode    |
| 2(3)                  | 0(4)                  | __modeflag    |

Figure 12. Example of a C listing (Part 21 of 33)

```

***** STRUCTURE MAPS *****

```

|      |      |                       |
|------|------|-----------------------|
| 2(7) | 0(1) | __dsorgPDSE           |
| 3    | 0(3) | __vsamRLS             |
| 3(3) | 0(1) | __vsamEA              |
| 3(4) | 0(4) | __reserve2            |
| 4    | 1    | __device              |
| 5    | 4    | __blksize             |
| 9    | 4    | __maxreclen           |
| 13   | 12   | __device_specific     |
| 13   | 12   | __vsam                |
| 13   | 2    | __vsam_type           |
| 15   | 2    | ***PADDING***         |
| 17   | 4    | __vsam_keylen         |
| 21   | 4    | __vsam_RKP            |
| 13   | 12   | __disk                |
| 13   | 2    | __disk_vsam_type      |
| 15   | 1    | __disk_access_method  |
| 16   | 1    | __disk_noseek_to_seek |
| 17   | 8    | __disk_reserve[2]     |
| 25   | 4    | __dsname              |
| 29   | 4    | __reserve4            |

---

```

=====
Aggregate map for: struct __fpos_t                               Total size: 32 bytes
.....
fpos_t
=====

```

| Offset<br>Bytes(Bits) | Length<br>Bytes(Bits) | Member Name    |
|-----------------------|-----------------------|----------------|
| 0                     | 32                    | __fpos_elem[8] |

---

```

=====
Aggregate map for: _Packed struct __fpos_t                       Total size: 32 bytes
.....
_Packed fpos_t
=====

```

| Offset<br>Bytes(Bits) | Length<br>Bytes(Bits) | Member Name    |
|-----------------------|-----------------------|----------------|
| 0                     | 32                    | __fpos_elem[8] |

---

```

=====
Aggregate map for: struct __S99emparms                            Total size: 28 bytes
.....
__S99emparms_t
=====

```

| Offset<br>Bytes(Bits) | Length<br>Bytes(Bits) | Member Name |
|-----------------------|-----------------------|-------------|
| 0                     | 1                     | __EMFUNCT   |
| 1                     | 1                     | __EMIDNUM   |
| 2                     | 1                     | __EMNMSGBK  |
| 3                     | 1                     | __filler1   |

Figure 12. Example of a C listing (Part 22 of 33)

```

***** STRUCTURE MAPS *****

```

|    |   |            |
|----|---|------------|
| 4  | 4 | __EMS99RBP |
| 8  | 4 | __EMRETCOD |
| 12 | 4 | __EMCPPLP  |
| 16 | 4 | __EMBUFP   |
| 20 | 4 | __reserv1  |
| 24 | 4 | __reserv2  |

---

Aggregate map for: \_Packed struct \_\_S99emparms Total size: 28 bytes

.....  
\_Packed \_\_S99emparms\_t  
.....

| Offset<br>Bytes(Bits) | Length<br>Bytes(Bits) | Member Name |
|-----------------------|-----------------------|-------------|
| 0                     | 1                     | __EMFUNCT   |
| 1                     | 1                     | __EMIDNUM   |
| 2                     | 1                     | __EMNMSGBK  |
| 3                     | 1                     | __filler1   |
| 4                     | 4                     | __EMS99RBP  |
| 8                     | 4                     | __EMRETCOD  |
| 12                    | 4                     | __EMCPPLP   |
| 16                    | 4                     | __EMBUFP    |
| 20                    | 4                     | __reserv1   |
| 24                    | 4                     | __reserv2   |

---

Aggregate map for: struct \_\_S99rbx Total size: 36 bytes

.....  
\_\_S99rbx\_t  
.....

| Offset<br>Bytes(Bits) | Length<br>Bytes(Bits) | Member Name |
|-----------------------|-----------------------|-------------|
| 0                     | 6                     | __S99EID[6] |
| 6                     | 1                     | __S99EVER   |
| 7                     | 1                     | __S99EOPTS  |
| 8                     | 1                     | __S99ESUBP  |
| 9                     | 1                     | __S99EKEY   |
| 10                    | 1                     | __S99EMGSV  |
| 11                    | 1                     | __S99ENMSG  |
| 12                    | 4                     | __S99ECPLP  |
| 16                    | 1                     | __reserved  |
| 17                    | 1                     | __S99ERES   |
| 18                    | 1                     | __S99ERCO   |
| 19                    | 1                     | __S99ERCF   |
| 20                    | 4                     | __S99EWRC   |
| 24                    | 4                     | __S99EMSGP  |
| 28                    | 2                     | __S99EERR   |
| 30                    | 2                     | __S99EINFO  |
| 32                    | 4                     | __reserv2   |

Figure 12. Example of a C listing (Part 23 of 33)



## \*\*\*\*\* STRUCTURE MAPS \*\*\*\*\*

| Aggregate map for: _Packed struct __S99rbx   |                       |             | Total size: 36 bytes |
|--|-----------------------|-------------|----------------------|
| .....  |                       |             |                      |
| _Packed __S99rbx_t                           |                       |             |                      |
| Offset<br>Bytes(Bits)                        | Length<br>Bytes(Bits) | Member Name |                      |
| =====  |                       |             |                      |
| 0  | 6                     | __S99EID[6] |                      |
| 6  | 1                     | __S99EVER   |                      |
| 7  | 1                     | __S99EOPTS  |                      |
| 8  | 1                     | __S99ESUBP  |                      |
| 9  | 1                     | __S99EKEY   |                      |
| 10   | 1                     | __S99EMGSV  |                      |
| 11   | 1                     | __S99ENMSG  |                      |
| 12   | 4                     | __S99ECPL   |                      |
| 16   | 1                     | __reserved  |                      |
| 17   | 1                     | __S99ERES   |                      |
| 18   | 1                     | __S99ERCO   |                      |
| 19   | 1                     | __S99ERCF   |                      |
| 20   | 4                     | __S99EWRC   |                      |
| 24   | 4                     | __S99EMSGP  |                      |
| 28   | 2                     | __S99EERR   |                      |
| 30   | 2                     | __S99EINFO  |                      |
| 32   | 4                     | __reserv2   |                      |
| =====  |                       |             |                      |
| Aggregate map for: struct __S99struc         |                       |             | Total size: 20 bytes |
| .....  |                       |             |                      |
| __S99parms                                   |                       |             |                      |
| Offset<br>Bytes(Bits)                        | Length<br>Bytes(Bits) | Member Name |                      |
| =====  |                       |             |                      |
| 0  | 1                     | __S99RBLN   |                      |
| 1  | 1                     | __S99VERB   |                      |
| 2  | 2                     | __S99FLAG1  |                      |
| 4  | 2                     | __S99ERROR  |                      |
| 6  | 2                     | __S99INFO   |                      |
| 8  | 4                     | __S99XTTP   |                      |
| 12   | 4                     | __S99S99X   |                      |
| 16   | 4                     | __S99FLAG2  |                      |
| =====  |                       |             |                      |
| Aggregate map for: _Packed struct __S99struc |                       |             | Total size: 20 bytes |
| .....  |                       |             |                      |
| _Packed __S99parms                           |                       |             |                      |
| Offset<br>Bytes(Bits)                        | Length<br>Bytes(Bits) | Member Name |                      |
| =====  |                       |             |                      |
| 0  | 1                     | __S99RBLN   |                      |
| 1  | 1                     | __S99VERB   |                      |
| =====  |                       |             |                      |

Figure 12. Example of a C listing (Part 24 of 33)

```

          * * * * * S T R U C T U R E   M A P S   * * * * *
|         2         |         2         |         _S99FLAG1
|         4         |         2         |         _S99ERROR
|         6         |         2         |         _S99INFO
|         8         |         4         |         _S99XTTP
|        12         |         4         |         _S99S99X
|        16         |         4         |         _S99FLAG2
|-----|-----|-----|
5694A01 V1.8 z/OS XL C          * * * * * E N D   O F   S T R U C T U R E   M A P S   * * * * *
                                'TSCTEST.ZOSV1R8.SCCNSAM(CCNUAAM)'
```

```

          * * * * * M E S S A G E   S U M M A R Y   * * * * *
Total          Informational(00)          Warning(10)          Error(30)          Severe Error(40)
0              0              0              0              0
          * * * * * E N D   O F   M E S S A G E   S U M M A R Y   * * * * *
5694A01 V1.8 z/OS XL C          'TSCTEST.ZOSV1R8.SCCNSAM(CCNUAAM)'
```

Inline Report (Summary)

Reason: P : noinline was specified for this routine  
F : inline was specified for this routine  
C : compact was specified for this routine  
M : This is an inline member routine  
A : Automatic inlining  
- : No reason

Action: I : Routine is inlined at least once  
L : Routine is initially too large to be inlined  
T : Routine expands too large to be inlined  
C : Candidate for inlining but not inlined  
N : No direct calls to routine are found in file (no action)  
U : Some calls not inlined due to recursion or parameter mismatch  
- : No action

Status: D : Internal routine is discarded  
R : A direct call remains to internal routine (cannot discard)  
A : Routine has its address taken (cannot discard)  
E : External routine (cannot discard)  
- : Status unchanged

Calls/I : Number of calls to defined routines / Number inline  
Called/I : Number of times called / Number of times inlined

| Reason | Action | Status | Size (init) | Calls/I | Called/I | Name    |
|--------|--------|--------|-------------|---------|----------|---------|
| A      | I      | E      | 15          | 0/0     | 2/2      | convert |
| A      | T,N    | E      | 116 (78)    | 2/2     | 0/0      | main    |

Mode = AUTO Inlining Threshold = 100 Expansion Limit = 1000

Figure 12. Example of a C listing (Part 25 of 33)

## Inline Report (Call Structure)

```
Defined Function      : convert
Calls To             : 0
Called From(2,2)    : main(2,2)
```

```
Defined Function      : main
Calls To(2,2)        : convert(2,2)
Called From           : 0
```

```
OFFSET OBJECT CODE      LINE# FILE# PSEUDO ASSEMBLY LISTING

Timestamp and Version Information
000000 F2F0 F0F6          =C'2006'          Compiled Year
000004 F0F1 F2F3          =C'0123'          Compiled Date MMDD
000008 F1F8 F5F7 F1F5    =C'185715'        Compiled Time HHMMSS
00000E F0F1 F0F8 F0F0    =C'010800'        Compiler Version

Timestamp and Version End
```

```
OFFSET OBJECT CODE      LINE# FILE# PSEUDO ASSEMBLY LISTING

000001 | * #include <stdio.h>
000002 | *
000003 | * #include "ccnuaan.h"
000004 | *
000005 | * void convert(double);
000006 | *
000007 | * int main(int argc, char **argv)
000007 | main DS 0D
000007 | B 34(,r15)
000018 47F0 F022          CEE eyecatcher
00001C 01C3C5C5          DSA size
000020 00000120          =A(PPA1-main)
000024 00000328          B 1(,r15)
000028 47F0 F001          000007 | L r15,796(,r12)
00002C 58F0 C31C          000007 | LR r4,r14
000030 184E              000007 | BALR r14,r15
000032 05EF              =F'0'
000034 00000000          BR r3
000038 07F3              000007 | STM r14,r5,12(r13)
00003A 90E5 D00C          000007 | L r14,76(,r13)
00003E 58E0 D04C          000007 | LA r0,288(,r14)
000042 4100 E120          000007 | CL r0,788(,r12)
000046 5500 C314          000007 | LA r3,58(,r15)
00004A 4130 F03A          000007 | BH 20(,r15)
00004E 4720 F014          000007 | L r15,640(,r12)
000052 58F0 C280          000007 | STM r15,r0,72(r14)
000056 90F0 E048          000007 | MVI 0(r14),16
00005A 9210 E000          000007 | ST r13,4(,r14)
00005E 50D0 E004          000007 | LR r13,r14
000062 18DE              End of Prolog
000064

000064 C050 0000 011E 000000 | LARL r5,F'286'
00006A 5010 D0D0 000007 | ST r1,#SR_PARM_1(,r13,208)
000008 | * {
000009 | * double c_temp;
000010 | *
000011 | * if (argc == 1) { /* get Celsius value from stdin */
000011 | L r1,#SR_PARM_1(,r13,208)
000011 | L r0,argc(,r1,0)
000011 | CHI r0,H'1'
000011 | BNE @1L1
000012 | * int ch;
000013 | *
000014 | * printf("Enter Celsius temperature: \n");
000014 | L r15,=V(PRINTF)(,r3,410)
000014 | LR r0,r5
000014 | LA r1,#MX_TEMP1(,r13,152)
000014 | ST r0,#MX_TEMP1(,r13,152)
000014 | BALR r14,r15
000015 | *
000016 | * if (scanf("%f", &c_temp) != 1) {
000016 | LA r0,c_temp(,r13,176)
000016 | L r15,=V(SCANF)(,r3,414)
000016 | LA r2,+CONSTANT_AREA(,r5,29)
```

Figure 12. Example of a C listing (Part 26 of 33)

```

00009A 4110 D098      000016 |          LA   r1,#MX_TEMP1(,r13,152)
00009E 5020 D098      000016 |          ST   r2,#MX_TEMP1(,r13,152)
5694A01 V1.8 z/OS XL C      'TSCTEST.ZOSV1R8.SCCNSAM(CCNUAAM)': main      01/23/2006 18:57:15   Page   32

OFFSET OBJECT CODE      LINE# FILE#  P S E U D O  A S S E M B L Y  L I S T I N G

0000A2 5000 D09C      000016 |          ST   r0,#MX_TEMP1(,r13,156)
0000A6 05EF          000016 |          BALR  r14,r15
0000A8 180F          000016 |          LR   r0,r15
0000AA A70E 0001      000016 |          CHI  r0,H'1'
0000AE 4780 3076      000016 |          BE   @1L2
000017 |          *          printf("You must enter a valid temperature\n");
0000B2 58F0 319A      000017 |          L    r15,=V(PRINTF)(,r3,410)
0000B6 4100 5020      000017 |          LA   r0,+CONSTANT_AREA(,r5,32)
0000BA 4110 D098      000017 |          LA   r1,#MX_TEMP1(,r13,152)
0000BE 5000 D098      000017 |          ST   r0,#MX_TEMP1(,r13,152)
0000C2 05EF          000017 |          BALR  r14,r15
0000C4 47F0 30AC      000017 |          B    @1L3
0000C8          000017 |          @1L2  DS   0H
000018 |          *          }
000019 |          *          else {
000020 |          *          convert(c_temp);
0000C8 6800 D0B0      000020 |          LD   f0,c_temp(,r13,176)
0000CC 6000 D0C0      000020 |          STD  f0,c_temp:convert(,r13,192)
000021 |          *          }
000022 |          *          }
000023 |          *          else { /* convert the command-line arguments to Fahrenheit */
000024 |          *          int i;
000025 |          *          for (i = 1; i < argc; ++i) {
000026 |          *          if (sscanf(argv[i], "%f", &c_temp) != 1)
000027 |          *          printf("%s is not a valid temperature\n",argv[i]);
000028 |          *          else
000029 |          *          convert(c_temp);
000030 |          *          }
000031 |          *          }
000032 |          *          return 0;
000033 |          *          }
000034 |          *          }
000035 |          *          }
000036 |          *          void convert(double c_temp) {
000037 |          *          double f_temp = (c_temp * CONV + OFFSET);
0000D0 6820 5048      000037 |          + LD   f2,+CONSTANT_AREA(,r5,72)
0000D4 2C02          000037 |          + MDR  f0,f2
0000D6 6820 5050      000037 |          + LD   f2,+CONSTANT_AREA(,r5,80)
0000DA 2A02          000037 |          + ADR  f0,f2
0000DC 6000 D0C8      000037 |          + STD  f0,f_temp:convert(,r13,200)
000038 |          *          printf("%5.2f Celsius is %5.2f Fahrenheit\n",c_temp, f_temp);
0000E0 6820 D0C0      000038 |          + LD   f2,c_temp:convert(,r13,192)
0000E4 6020 D09C      000038 |          + STD  f2,#MX_TEMP1(,r13,156)
0000E8 6000 D0A4      000038 |          + STD  f0,#MX_TEMP1(,r13,164)
0000EC 58F0 319A      000038 |          + L    r15,=V(PRINTF)(,r3,410)
0000F0 4100 5058      000038 |          + LA   r0,+CONSTANT_AREA(,r5,88)
0000F4 4110 D098      000038 |          + LA   r1,#MX_TEMP1(,r13,152)
0000F8 5000 D098      000038 |          + ST   r0,#MX_TEMP1(,r13,152)
0000FC 05EF          000038 |          + BALR  r14,r15
000039 |          *          }
0000FE          000039 |          +@1L11 DS   0H
0000FE          000039 |          +@1L3  DS   0H
0000FE 47F0 3180      000039 |          + B    @1L4
000102          000039 |          +@1L1  DS   0H
000102          000039 |          +@1L5  DS   0H
000102 4100 0001      000026 |          LA   r0,1

```

Figure 12. Example of a C listing (Part 27 of 33)

| OFFSET | OBJECT | CODE | LINE#  | FILE#  | P S E U D O | A S S E M B L Y             | L I S T I N G |
|--------|--------|------|--------|--------|-------------|-----------------------------|---------------|
| 000106 | 5000   | D0B8 | 000026 |        | ST          | r0,i(,r13,184)              |               |
| 00010A | 5810   | D0D0 | 000026 |        | L           | r1,#SR_PARM_1(,r13,208)     |               |
| 00010E | 5810   | 1000 | 000026 |        | L           | r1,argc(,r1,0)              |               |
| 000112 | 1901   |      | 000026 |        | CR          | r0,r1                       |               |
| 000114 | 47B0   | 3180 | 000026 |        | BNL         | @1L8                        |               |
| 000118 |        |      | 000026 | @1L7   | DS          | 0H                          |               |
| 000118 | 5810   | D0D0 | 000027 |        | L           | r1,#SR_PARM_1(,r13,208)     |               |
| 00011C | 5810   | 1004 | 000027 |        | L           | r1,argv(,r1,4)              |               |
| 000120 | 5820   | D0B8 | 000027 |        | L           | r2,i(,r13,184)              |               |
| 000124 | 8920   | 0002 | 000027 |        | SLL         | r2,2                        |               |
| 000128 | 5822   | 1000 | 000027 |        | L           | r2,(*)uchar*(r2,r1,0)       |               |
| 00012C | 4100   | D0B0 | 000027 |        | LA          | r0,c_temp(,r13,176)         |               |
| 000130 | 58F0   | 31A2 | 000027 |        | L           | r15,=V(SSCANF)(,r3,418)     |               |
| 000134 | 4110   | D098 | 000027 |        | LA          | r1,#MX_TEMP1(,r13,152)      |               |
| 000138 | 5020   | D098 | 000027 |        | ST          | r2,#MX_TEMP1(,r13,152)      |               |
| 00013C | 4120   | 501D | 000027 |        | LA          | r2,+CONSTANT_AREA(,r5,29)   |               |
| 000140 | 5020   | D09C | 000027 |        | ST          | r2,#MX_TEMP1(,r13,156)      |               |
| 000144 | 5000   | D0A0 | 000027 |        | ST          | r0,#MX_TEMP1(,r13,160)      |               |
| 000148 | 05EF   |      | 000027 |        | BALR        | r14,r15                     |               |
| 00014A | 180F   |      | 000027 |        | LR          | r0,r15                      |               |
| 00014C | A70E   | 0001 | 000027 |        | CHI         | r0,H'1'                     |               |
| 000150 | 4780   | 3130 | 000027 |        | BE          | @1L9                        |               |
| 000154 | 5810   | D0D0 | 000028 |        | L           | r1,#SR_PARM_1(,r13,208)     |               |
| 000158 | 5810   | 1004 | 000028 |        | L           | r1,argv(,r1,4)              |               |
| 00015C | 5820   | D0B8 | 000028 |        | L           | r2,i(,r13,184)              |               |
| 000160 | 8920   | 0002 | 000028 |        | SLL         | r2,2                        |               |
| 000164 | 5802   | 1000 | 000028 |        | L           | r0,(*)uchar*(r2,r1,0)       |               |
| 000168 | 58F0   | 319A | 000028 |        | L           | r15,=V(PRINTF)(,r3,410)     |               |
| 00016C | 4120   | 507B | 000028 |        | LA          | r2,+CONSTANT_AREA(,r5,123)  |               |
| 000170 | 4110   | D098 | 000028 |        | LA          | r1,#MX_TEMP1(,r13,152)      |               |
| 000174 | 5020   | D098 | 000028 |        | ST          | r2,#MX_TEMP1(,r13,152)      |               |
| 000178 | 5000   | D09C | 000028 |        | ST          | r0,#MX_TEMP1(,r13,156)      |               |
| 00017C | 05EF   |      | 000028 |        | BALR        | r14,r15                     |               |
| 00017E | 47F0   | 3166 | 000028 |        | B           | @1L10                       |               |
| 000182 |        |      | 000028 | @1L9   | DS          | 0H                          |               |
| 000182 | 6800   | D0B0 | 000030 |        | LD          | f0,c_temp(,r13,176)         |               |
| 000186 | 6000   | D0C0 | 000030 |        | STD         | f0,c_temp:convert(,r13,192) |               |
| 00018A | 6820   | 5048 | 000037 | +      | LD          | f2,+CONSTANT_AREA(,r5,72)   |               |
| 00018E | 2C02   |      | 000037 | +      | MDR         | f0,f2                       |               |
| 000190 | 6820   | 5050 | 000037 | +      | LD          | f2,+CONSTANT_AREA(,r5,80)   |               |
| 000194 | 2A02   |      | 000037 | +      | ADR         | f0,f2                       |               |
| 000196 | 6000   | D0C8 | 000037 | +      | STD         | f0,f_temp:convert(,r13,200) |               |
| 00019A | 6820   | D0C0 | 000038 | +      | LD          | f2,c_temp:convert(,r13,192) |               |
| 00019E | 6020   | D09C | 000038 | +      | STD         | f2,#MX_TEMP1(,r13,156)      |               |
| 0001A2 | 6000   | D0A4 | 000038 | +      | STD         | f0,#MX_TEMP1(,r13,164)      |               |
| 0001A6 | 58F0   | 319A | 000038 | +      | L           | r15,=V(PRINTF)(,r3,410)     |               |
| 0001AA | 4100   | 5058 | 000038 | +      | LA          | r0,+CONSTANT_AREA(,r5,88)   |               |
| 0001AE | 4110   | D098 | 000038 | +      | LA          | r1,#MX_TEMP1(,r13,152)      |               |
| 0001B2 | 5000   | D098 | 000038 | +      | ST          | r0,#MX_TEMP1(,r13,152)      |               |
| 0001B6 | 05EF   |      | 000038 | +      | BALR        | r14,r15                     |               |
| 0001B8 |        |      | 000039 | +@1L12 | DS          | 0H                          |               |
| 0001B8 |        |      | 000039 | +@1L10 | DS          | 0H                          |               |
| 0001B8 | 5800   | D0B8 | 000039 | +      | L           | r0,i(,r13,184)              |               |
| 0001BC | A70A   | 0001 | 000039 | +      | AHI         | r0,H'1'                     |               |
| 0001C0 | 5000   | D0B8 | 000039 | +      | ST          | r0,i(,r13,184)              |               |
| 0001C4 | 5810   | D0D0 | 000039 | +      | L           | r1,#SR_PARM_1(,r13,208)     |               |

Figure 12. Example of a C listing (Part 28 of 33)

```

OFFSET OBJECT CODE      LINE#  FILE#  P S E U D O  A S S E M B L Y  L I S T I N G
0001C8 5810 1000        000039 |      +      L    r1,argc(,r1,0)
0001CC 1901              000039 |      +      CR    r0,r1
0001CE 4740 30C6        000039 |      +      BL    @1L7
0001D2              000039 |    +@1L8    DS    0H
0001D2              000039 |    +@1L4    DS    0H
0001D2 41F0 0000        000033 |          LA    r15,0
0001D6 47F0 3188        000033 |          B     @1L14
0001DA              000034 |    @1L6    DS    0H
0001DA              000034 |    @1L14   DS    0H

0001DA              Start of Epilog
0001DA 180D              000034 |          LR    r0,r13
0001DC 58D0 D004        000034 |          L     r13,4(,r13)
0001E0 58E0 D00C        000034 |          L     r14,12(,r13)
0001E4 9825 D01C        000034 |          LM    r2,r5,28(r13)
0001E8 051E              000034 |        BALR  r1,r14
0001EA 0707              000034 |        NOPR  7

0001EC              Start of Literals
0001EC 00000000              =V(PRINTF)
0001F0 00000000              =V(SCANF)
0001F4 00000000              =V(SSCANF)
0001F8              End of Literals

***  General purpose registers used: 1111110000001111
***  Floating point registers used: 1111111000000000
***  Size of register spill area: 128(max) 0(used)
***  Size of dynamic storage: 288
***  Size of executable code: 468

```

Figure 12. Example of a C listing (Part 29 of 33)

| OFFSET | OBJECT CODE | LINE#  | FILE# | P S E U D O  | A S S E M B L Y | L I S T I N G    |
|--------|-------------|--------|-------|--|-----------------|------------------|
|        |             | 000001 |       | * #include <stdio.h>   |                 |                  |
|        |             | 000002 |       | *  |                 |                  |
|        |             | 000003 |       | * #include "ccnuaan.h"   |                 |                  |
|        |             | 000004 |       | *  |                 |                  |
|        |             | 000005 |       | * void convert(double);  |                 |                  |
|        |             | 000006 |       | *  |                 |                  |
|        |             | 000007 |       | * int main(int argc, char **argv)                                    |                 |                  |
|        |             | 000008 |       | * {  |                 |                  |
|        |             | 000009 |       | *     double c_temp;   |                 |                  |
|        |             | 000010 |       | *  |                 |                  |
|        |             | 000011 |       | *     if (argc == 1) { /* get Celsius value from stdin */            |                 |                  |
|        |             | 000012 |       | *         int ch;  |                 |                  |
|        |             | 000013 |       | *  |                 |                  |
|        |             | 000014 |       | *         printf("Enter Celsius temperature: \n");                   |                 |                  |
|        |             | 000015 |       | *  |                 |                  |
|        |             | 000016 |       | *         if (scanf("%f", &c_temp) != 1) {                           |                 |                  |
|        |             | 000017 |       | *             printf("You must enter a valid temperature\n");        |                 |                  |
|        |             | 000018 |       | *         }  |                 |                  |
|        |             | 000019 |       | *         else {   |                 |                  |
|        |             | 000020 |       | *             convert(c_temp);                                       |                 |                  |
|        |             | 000021 |       | *         }  |                 |                  |
|        |             | 000022 |       | *     }  |                 |                  |
|        |             | 000023 |       | *     else { /* convert the command-line arguments to Fahrenheit */  |                 |                  |
|        |             | 000024 |       | *         int i;   |                 |                  |
|        |             | 000025 |       | *  |                 |                  |
|        |             | 000026 |       | *         for (i = 1; i < argc; ++i) {                               |                 |                  |
|        |             | 000027 |       | *             if (sscanf(argv[i], "%f", &c_temp) != 1)               |                 |                  |
|        |             | 000028 |       | *                 printf("%s is not a valid temperature\n",argv[i]); |                 |                  |
|        |             | 000029 |       | *             else   |                 |                  |
|        |             | 000030 |       | *                 convert(c_temp);                                   |                 |                  |
|        |             | 000031 |       | *             }  |                 |                  |
|        |             | 000032 |       | *         }  |                 |                  |
|        |             | 000033 |       | *         return 0;  |                 |                  |
|        |             | 000034 |       | *     }  |                 |                  |
|        |             | 000035 |       | *  |                 |                  |
|        |             | 000036 |       | * void convert(double c_temp) {                                      |                 |                  |
| 0001F8 |             | 000036 |       | convert  | DS              | 0D               |
| 0001F8 | 47F0 F022   | 000036 |       |  | B               | 34(,r15)         |
| 0001FC | 01C3C5C5    |        |       |  |                 | CEE eyecatcher   |
| 000200 | 00000100    |        |       |  |                 | DSA size         |
| 000204 | 00000188    |        |       |  |                 | =A(PPA1-convert) |
| 000208 | 47F0 F001   | 000036 |       |  | B               | 1(,r15)          |
| 00020C | 58F0 C31C   | 000036 |       |  | L               | r15,796(,r12)    |
| 000210 | 184E        | 000036 |       |  | LR              | r4,r14           |
| 000212 | 05EF        | 000036 |       |  | BALR            | r14,r15          |
| 000214 | 00000000    |        |       |  |                 | =F'0'            |
| 000218 | 07F3        | 000036 |       |  | BR              | r3               |
| 00021A | 90E5 D00C   | 000036 |       |  | STM             | r14,r5,12(r13)   |
| 00021E | 58E0 D04C   | 000036 |       |  | L               | r14,76(,r13)     |
| 000222 | 4100 E100   | 000036 |       |  | LA              | r0,256(,r14)     |
| 000226 | 5500 C314   | 000036 |       |  | CL              | r0,788(,r12)     |
| 00022A | 4130 F03A   | 000036 |       |  | LA              | r3,58(,r15)      |
| 00022E | 4720 F014   | 000036 |       |  | BH              | 20(,r15)         |
| 000232 | 58F0 C280   | 000036 |       |  | L               | r15,640(,r12)    |
| 000236 | 90F0 E048   | 000036 |       |  | STM             | r15,r0,72(r14)   |
| 00023A | 9210 E000   | 000036 |       |  | MVI             | 0(r14),16        |

Figure 12. Example of a C listing (Part 30 of 33)

```

OFFSET OBJECT CODE      LINE# FILE#  P S E U D O  A S S E M B L Y  L I S T I N G
00023E 50D0 E004        000036 |          ST  r13,4(,r14)
000242 18DE          000036 |          LR  r13,r14
000244          End of Prolog

000244 C050 0000 002E 000000 |          LARL r5,F'46'
00024A 5010 D0B8        000036 |          ST  r1,#SR_PARM_2(,r13,184)
000037 *          double f_temp = (c_temp * CONV + OFFSET);
00024E 5810 D0B8        000037 |          L   r1,#SR_PARM_2(,r13,184)
000252 6800 1000        000037 |          LD  f0,c_temp(,r1,0)
000256 6820 5048        000037 |          LD  f2,+CONSTANT_AREA(,r5,72)
00025A 2C02          000037 |          MDR f0,f2
00025C 6820 5050        000037 |          LD  f2,+CONSTANT_AREA(,r5,80)
000260 2A02          000037 |          ADR f0,f2
000262 6000 D0B0        000037 |          STD f0,f_temp(,r13,176)
000038 *          printf("%5.2f Celsius is %5.2f Fahrenheit\n",c_temp, f_temp);
000266 5810 D0B8        000038 |          L   r1,#SR_PARM_2(,r13,184)
00026A 6820 1000        000038 |          LD  f2,c_temp(,r1,0)
00026E 6020 D09C        000038 |          STD f2,#MX_TEMP2(,r13,156)
000272 6000 D0A4        000038 |          STD f0,#MX_TEMP2(,r13,164)
000276 58F0 3066        000038 |          L   r15,=V(PRINTF)(,r3,102)
00027A 4100 5058        000038 |          LA  r0,+CONSTANT_AREA(,r5,88)
00027E 4110 D098        000038 |          LA  r1,#MX_TEMP2(,r13,152)
000282 5000 D098        000038 |          ST  r0,#MX_TEMP2(,r13,152)
000286 05EF          000038 |          BALR r14,r15
000039 * }
000288          000039 |          @2L15 DS  0H

000288          Start of Epilog
000288 58D0 D004        000039 |          L   r13,4(,r13)
00028C 58E0 D00C        000039 |          L   r14,12(,r13)
000290 9825 D01C        000039 |          LM  r2,r5,28(r13)
000294 051E          000039 |          BALR r1,r14
000296 0707          000039 |          NOPR 7

000298          Start of Literals
000298 00000000          =V(PRINTF)
00029C          End of Literals

*** General purpose registers used: 1101110000001111
*** Floating point registers used: 1111111100000000
*** Size of register spill area: 128(max) 0(used)
*** Size of dynamic storage: 256
*** Size of executable code: 160

00029C 0000 0000

Constant Area
0002A0 C595A385 9940C385 93A289A4 A240A385 |Enter Celsius te
0002B0 94978599 81A3A499 857A4015 006C8600 |mperature: ..%f.
0002C0 E896A440 94A4A2A3 408595A3 85994081 |You must enter a
0002D0 40A58193 898440A3 85949785 9981A3A4 |valid temperatu
0002E0 99851500 C9C2D440 411CCCCC CCCCCCCC |re..IBM .....
0002F0 42200000 00000000 6CF54BF2 8640C385 |.....%5.2f Ce
000300 93A289A4 A24089A2 406CF54B F28640C6 |lsius is %5.2f F
000310 81889985 95888589 A315006C A24089A2 |ahrenheit..%s is
000320 409596A3 408140A5 81938984 40A38594 |not a valid tem

```

Figure 12. Example of a C listing (Part 31 of 33)



OFFSET OBJECT CODE LINE# FILE# P S E U D O A S S E M B L Y L I S T I N G

OFFSET OBJECT CODE LINE# FILE# P S E U D O A S S E M B L Y L I S T I N G

```

PPA1: Entry Point Constants
000340 1CCEA106                =F'483303686'    Flags
000344 000003B0                =A(PPA2-main)
000348 00000000                =F'0'            No PPA3
00034C 00000000                =F'0'            No EPD
000350 FF000000                =F'-16777216'   Register save mask
000354 00000000                =F'0'            Member flags
000358 90                        =AL1(144)        Flags
000359 00000000                =AL3(0)          Callee's DSA use/8
00035C 0040                    =H'64'           Flags
00035E 0012                    =H'18'           Offset/2 to CDL
000360 00000000                =F'0'            Reserved
000364 500000EA                =F'1342177514'  CDL function length/2
000368 FFFFFFFCD8                =F'-808'         CDL function EP offset
00036C 38260000                =F'942014464'   CDL prolog
000370 400900E1                =F'1074331873'  CDL epilog
000374 00000000                =F'0'            CDL end
000378 0004 ****                AL2(4),C'main'
    
```

PPA1 End

```

PPA1: Entry Point Constants
000380 1CCEA106                =F'483303686'    Flags
000384 000001D0                =A(PPA2-convert)
000388 00000000                =F'0'            No PPA3
00038C 00000000                =F'0'            No EPD
000390 FF000000                =F'-16777216'   Register save mask
000394 00000000                =F'0'            Member flags
000398 90                        =AL1(144)        Flags
000399 00000000                =AL3(0)          Callee's DSA use/8
00039C 0040                    =H'64'           Flags
00039E 0012                    =H'18'           Offset/2 to CDL
0003A0 00000000                =F'0'            Reserved
0003A4 50000050                =F'1342177360'  CDL function length/2
0003A8 FFFFFFFE78                =F'-392'         CDL function EP offset
0003AC 38260000                =F'942014464'   CDL prolog
0003B0 40080048                =F'1074266184'  CDL epilog
0003B4 00000000                =F'0'            CDL end
0003B8 0007 ****                AL2(7),C'convert'
    
```

PPA1 End

PPA2: Compile Unit Block

```

0003C8 0300 2202                =F'50340354'    Flags
0003CC FFFF FC38                =A(CEESTART-PPA2)
0003D0 0000 0000                =F'0'            No PPA4
0003D4 FFFF FC38                =A(TIMESTMP-PPA2)
0003D8 0000 0000                =F'0'            No primary
0003DC 0000 0000                =F'0'            Flags
    
```

PPA2 End

Figure 12. Example of a C listing (Part 32 of 33)

```

5694A01 V1.8 z/OS XL C          'TSCTEST.ZOSV1R8.SCCNSAM(CCNAAAM)'          01/23/2006 18:57:15 Page 39
                                E X T E R N A L   S Y M B O L   D I C T I O N A R Y
                                NAME          TYPE ID ADDR LENGTH          NAME          TYPE ID ADDR LENGTH
                                CONVERT      PC 1 000000 0003E0          MAIN          LD 0 000018 000001
                                PRINTF      LD 0 0001F8 000001          CEESG003      ER 2 000000
                                SSCANF      ER 3 000000          SCANF         ER 4 000000
                                CEEMAIN     ER 5 000000          CEESTART      ER 6 000000
                                MAIN        SD 7 000000 00000C          EDCINPL       ER 8 000000
                                ER 9 000000
5694A01 V1.8 z/OS XL C          'TSCTEST.ZOSV1R8.SCCNSAM(CCNAAAM)'          01/23/2006 18:57:15 Page 40

```

```

                                E X T E R N A L   S Y M B O L   C R O S S   R E F E R E N C E
                                ORIGINAL NAME          EXTERNAL SYMBOL NAME
                                main                  MAIN
                                convert                CONVERT
                                CEESG003              CEESG003
                                printf                PRINTF
                                scanf                 SCANF
                                sscanf                SSCANF
                                CEESTART              CEESTART
                                CEEMAIN                CEEMAIN
                                EDCINPL              EDCINPL
5694A01 V1.8 z/OS XL C          'TSCTEST.ZOSV1R8.SCCNSAM(CCNAAAM)'          01/23/2006 18:57:15 Page 41

```

```

                                * * * * *   S T O R A G E   O F F S E T   L I S T I N G   * * * * *
IDENTIFIER          DEFINITION          ATTRIBUTES
argc                7-0:7                Class = parameter,      Location = 0(r1),      Length = 4
argv                7-0:7                Class = parameter,      Location = 4(r1),      Length = 4
c_temp              9-0:9                Class = automatic,      Location = 176(r13),   Length = 8
i                   24-0:24             Class = automatic,      Location = 184(r13),   Length = 4
c_temp              36-0:36             Class = parameter,      Location = 0(r1),      Length = 8
f_temp              37-0:37             Class = automatic,      Location = 176(r13),   Length = 8
                                * * * * *   E N D   O F   S T O R A G E   O F F S E T   L I S T I N G   * * * * *
                                * * * * *   E N D   O F   C O M P I L A T I O N   * * * * *

```

Figure 12. Example of a C listing (Part 33 of 33)

## z/OS XL C compiler listing components

The following sections describe the components of a C compiler listing. These are available for regular and IPA compilations. Differences in the IPA versions of the listings are noted. “Using the IPA Link step listing” on page 271 describes IPA-specific listings.

### Heading information

The first page of the listing is identified by the product number, the compiler version and release numbers, the name of the data set or z/OS UNIX System Services file containing the source code, the date and time compilation began (formatted according to the current locale), and the page number.

**Note:** If the name of the data set or z/OS UNIX file that contains the source code is greater than 32 characters, it is truncated. Only the right-most 32 characters appear in the listing.

## Prolog section

The Prolog section provides information about the compile-time library, file identifiers, compiler options, and other items in effect when the compiler was invoked.

All options except those with no default (for example, DEFINE) are shown in the listing. Any problems with the compiler options appear after the body of the Prolog section.

**IPA considerations:** If you specify IPA suboptions that are irrelevant to the IPA Compile step, the Prolog does not display them. If IPA processing is not active, IPA suboptions do not appear in the Prolog.

The following sections describe the optional parts of the listing and the compiler options that generate them.

## Source program

If you specify the SOURCE option, the listing file includes input to the compiler.

**Note:** If you specify the SHOWINC option, the source listing shows the included text after the #include directives.

## Includes section

The compiler generates the Includes section when you use include files, and specify the options SOURCE, LIST, or INLRPT.

## Cross-Reference Listing

The XREF option generates a cross-reference table that contains a list of the identifiers from the source program and the line numbers in which they appear.

## Structure and Union Maps

You obtain structure and union maps by using the AGGREGATE option. The table shows how each structure and union in the program is mapped. It contains the following:

- Name of the structure or union and the elements within the structure or union
- Byte offset of each element from the beginning of the structure or union, and the bit offset for unaligned bit data
- Length of each element
- Total length of each structure, union, and substructure

## Messages

If the preprocessor or the compiler detects an error, or the possibility of an error, it generates messages. If you specify the SOURCE compiler option, preprocessor error messages appear immediately after the source statement in error. You can generate your own messages in the preprocessing stage by using the **#error** preprocessor directive. For information on **#error**, see the *z/OS XL C/C++ Language Reference*.

If you specify the compiler options CHECKOUT or INFO(), the compiler will generate informational diagnostic messages.

For more information on the compiler messages, see “FLAG | NOFLAG” on page 105, and *z/OS XL C/C++ Messages*.

## Message Summary

This listing section displays the total number of messages and the number of messages for each severity level.

## Inline Report

If you specify the OPTIMIZE and INLINE(,REPORT,,) options, or the OPTIMIZE and INLRPT options, an Inline Report is included in the listing. This report contains an inline summary and a detailed call structure.

**Note:** No report is produced when your source file contains only one defined subprogram.

The summary contains information such as:

- Name of each defined subprogram. Subprogram names appear in alphabetical order.
- Reason for action on a subprogram:
  - The P indicates that **#pragma noline** and the COMPACT compiler option are not in effect.
  - The F indicates that the subprogram was declared inline, either by **#pragma inline** for C or the `inline` keyword for C++.
  - The C indicates that the COMPACT compiler option is specified for **#pragma\_override(FuncName,"OPT(COMPACT,yes)"** is specified in the source code.
  - The M indicates that C++ routine is an inline member routine.
  - The A indicates automatic inlining acted on the subprogram.
  - The - indicates there was no reason to inline the subprogram.
- Action on a subprogram:
  - Subprogram was inlined at least once.
  - Subprogram was not inlined because of initial size constraints.
  - Subprogram was not inlined because of expansion beyond size constraint.
  - Subprogram was a candidate for inlining, but was not inlined.
  - Subprogram was a candidate for inlining, but was not referenced.
  - The subprogram is directly recursive, or some calls have mismatching parameters.

Note: "Called" and "Calls" in the actions section of the inline report indicate how many times a function has been called or has called other functions, regardless of whether or not the callers or callees have been inlined.

- Status of original subprogram after inlining:
  - Subprogram is discarded because it is no longer referenced and is defined as `static internal`.
  - Subprogram was not discarded for various reasons :
    - Subprogram is external. (It can be called from outside the compilation unit.)
    - A call to this subprogram remains.
    - Subprogram has its address taken.
- Initial relative size of subprogram (in Abstract Code Units (ACU)).
- Final relative size of subprogram (in ACUs) after inlining.
- Number of calls within the subprogram and the number of these calls that were inlined into subprogram.
- Number of times the subprogram is called by others in the compile unit and the number of times the subprogram was inlined.
- Mode that is selected and the value of *threshold* and *limit* specified for the compilation.

The detailed call structure contains specific information of each subprogram such as:

- Subprograms that it calls
- Subprograms that call it
- Subprograms in which it is inlined

The information can help you to better analyze your program if you want to use the inliner in selective mode.

Inlining may result in additional messages. For example, if inlining a subprogram with automatic storage increases the automatic storage of the subprogram it is being inlined into by more than 4K, a message is generated.

### **Pseudo Assembly Listing**

The LIST compiler option generates a listing of the machine instructions in the object module in a form similar to assembler language.

This Pseudo Assembly listing displays the source statement line numbers and the line number of inlined code to aid you in debugging inlined code.

### **External Symbol Dictionary**

The LIST compiler option generates the External Symbol Dictionary. The External Symbol Dictionary lists the names that the compiler generates for the output object module. It includes address information and size information about each symbol.

### **External Symbol Cross Reference**

The XREF compiler option generates the External Symbol Cross Reference section. It shows the original name and corresponding mangled name for each symbol.

### **Storage Offset Listing**

If you specify the XREF option, the listing file includes offset information on identifiers.

### **Static Map**

Static Map displays the contents of the @STATIC data area, which holds the file scope read/write static variables. It displays the offset (as a hexadecimal number), the length (as a hexadecimal number), and the names of the objects mapped to @STATIC. Under certain circumstances, the compiler may decide to map other objects to @STATIC. In the example of the listing, the unnamed string "Enter Celsius temperature: \n" is stored in the @STATIC area at offset 48 and its length is 23 (both numbers are in hexadecimal notation), under the name ""12.

If you specify the XREF, IPA (ATTRIBUTE), or IPA (XREF) options, the listing file includes offset information for file scope read/write static variables.

---

## **Using the z/OS XL C++ compiler listing**

If you select the SOURCE, INLRPT, or LIST option, the compiler creates a listing that contains information about the source program and the compilation. If the compilation terminates before reaching a particular stage of processing, the compiler does not generate corresponding parts of the listing. The listing contains standard information that always appears, together with optional information that is supplied by default or specified through compiler options.

In an interactive environment you can also use the TERMINAL option to direct all compiler diagnostic messages to your terminal. The TERMINAL option directs only the diagnostic messages part of the compiler listing to your terminal.

**Notes:**

1. Although the compiler listing is for your use, it is not a programming interface and is subject to change.
2. The compiler always attempts to put diagnostic messages in the listing, as close as possible to the location where the condition occurred. The exact location or line number within the listing may not be the same from release to release.

**IPA considerations**

The listings that the IPA Compile step produces are basically the same as those that a regular compilation produces. Any differences are noted throughout this section.

The IPA Link step listing has a separate format from the listings mentioned above. Many listing sections are similar to those that are produced by a regular compilation or the IPA Compile step with the IPA(OBJECT) option specified. Refer to “Using the IPA Link step listing” on page 271 for information about IPA Link step listings.

**Example of a C++ compiler listing**

Figure 13 on page 259 shows an example of a z/OS XL C++ compiler listing. Vertical ellipses indicate sections that have been truncated.

```

5694A01 V1.8 z/OS XL C++          //'TSCTEST.ZOSV1R8.SCCNSAM(CCNUBRC)'          01/23/2006 18:58:17
          * * * * * P R O L O G * * * * *
Compiler options. . . . . : AGGRCOPY(NOOVERLAP)      ANSIALIAS      ARCH(5)      ARGPARSE      NOASCII
: NOATTRIBUTE      BITFIELD(UNSIGNED)      CHARS(UNSIGNED) NOCOMPACT      NOCOMPRESS
: CVFT      DIGRAPH      DLL(NOCALLBACKANY)      ENUMSIZE(SMALL) NOEVENTS
: EXECOPS      EXH      NOEXPMAC      NOEXPORTALL      NOFASTTEMPINC FLAG(1)
: NOGOFF      NOGONUMBER      HALT(16)      NOHGPR(NOPRESERVE)      NOHOT
: NOIGNERRNO      ILP32      NOINITAUTO      INLRPT      NOLIBANSI      LIST
: LONGNAME      LONGLONG      NOMARGINS      MAXMEM(2097152) MEMORY
: NAMEMANGLING(ANSI)      NESTINC(255)      OBJECT      OBJECTMODEL(COMPAT)
: NOOE      NOOFFSET      NOOPTIMIZE      PLIST(HOST)      NOPORT      NOPPONLY
: REDIR      ROSTRING      ROCONST      NORTTI      NOSEQUENCE      NOSHOWINC
: SOURCE      SPILL(128)      START      NOSTATICINLINE      STRICT
: NOSTRICT_INDUCTION      TARGET(LE,CURRENT)      NOTEMPLATEREGISTRY
: TEMPLATERECOMPILE      TERMINAL      NOTEST(HOOK)      TMPLPARSE(NO)      TUNE(5)
: UNROLL(AUTO)      NOWARN64      NOWSIZEOF      XREF
: NOCICS
: NOCONVLIT
: NOCSECT
: NODEBUG
: FLOAT(HEX,FOLD,AFP(NOVOLATILE)) ROUND(Z)
: INFO(LAN)
: INLINE(AUTO,REPORT,100,1000)
: NOIPA
: LANGLVL(ANONSTRUCT,ANONUNION,ANSIFOR,ANSISINIT,DBCS,NODOLLARINAMES,EMPTYSTRUCT,ILLPTOM,
IMPLICITINT,LIBEXT,LOGLONG,NEWEXCP,OFFSETNONPOD,NOOLDDIGRAPH,OLDFRIEND,NOOLDMATH,OLDTEMPACC,
NOOLDTMPLALIGN,OLDTMPLSPEC,TRAILENUM,TYPEDEFCLASS,NOUCS,ZEROEXTARRAY)
: NOLOCALE
: LSEARCH()
: OPTFILE(DD:OPTS)
: SEARCH('//'TSCTEST.CEEZ180.SCEEH.+' //'TSCTEST.ZOSV1R8.SCLBH.+' )
: NOSERVICE
: NOSQL
: NOSUPPRESS
: TEMPINC(/tempinc)
: NOXPLINK(NOBACKCHAIN,NOCALLBACK,GUARD,OSCALL(UPSTACK),NOSTOREARGS)
Version Macros. . . . . : __COMPILER_VER__=0x41080000
: __LIBREL__=0x41080000
: __TARGET_LIB__=0x41080000
Source margins. . . . . :
Varying length. . . . . : 1 - 32760
Fixed length. . . . . : 1 - 32760
Sequence columns. . . . . :
Varying length. . . . . : none
Fixed length. . . . . : none
Listing name. . . . . : DD:SYSPRT
          * * * * * E N D   O F   P R O L O G * * * * *

```

Figure 13. Example of a C++ compiler listing (Part 1 of 14)

```

          * * * * * S O U R C E * * * * *
1 //
2 // Sample Program: Biorhythm
3 // Description   : Calculates biorhythm based on the current
4 //                system date and birth date entered
5 //
6 // File 2 of 2-other file is CCNUBRH
7
8 #include <stdio.h>
9 #include <string.h>
10 #include <math.h>
11 #include <time.h>
12 #include <iostream>
13 #include <iomanip>
14
15 #include "ccnubrh.h" //BioRhythm class and Date class
16 using namespace std;
17 static ostream& operator << (ostream&, BioRhythm&);
18
19
20 int main(void) {
21     BioRhythm bio;
22     int code;
23
24     if (!bio.ok()) {
25         cerr << "Error in birthdate specification - format is yyyy/mm/dd";
26         code = 8;
27     }
28     else {
29         cout << bio; // write out birthdate for bio
30         code = 0;
31     }
32     return(code);
33 }
34
35
36 const int Date::dateLen ;
37 const int Date::numMonths;
38 const int Date::numDays[Date::numMonths] = {
39     31, 28, 31, 30, 31, 30, 31, 31, 30, 31, 30, 31
40 };
41
42 const int BioRhythm::pCycle;
43 const int BioRhythm::eCycle;
44 const int BioRhythm::iCycle;
45
46 ostream& operator<<(ostream& os, BioRhythm& bio) {
47     os << "Total Days   : " << bio.AgeInDays() << "\n";
48     os << "Physical     : " << bio.Physical() << "\n";
49     os << "Emotional    : " << bio.Emotional() << "\n";

```

Figure 13. Example of a C++ compiler listing (Part 2 of 14)



```

50 | os << "Intellectual: " << bio.Intellectual() << "\n";
51 |
52 | return(os);
53 | }
54 |
55 | Date::Date() {
56 |     time_t lTime;
57 |     struct tm *newTime;
58 |
59 |     time(&lTime);
60 |     newTime = localtime(&lTime);
61 |     cout << "local time is " << asctime(newTime) << endl;
62 |
63 |     curYear = newTime->tm_year + 1900;
64 |     curDay = newTime->tm_yday + 1;
65 | }
66 |
67 | BirthDate::BirthDate(const char *birthText) {
68 |     strcpy(text, birthText);
69 | }
70 |
71 | BirthDate::BirthDate() {
72 |     cout << "Please enter your birthdate in the form yyyy/mm/dd\n";
73 |     cin >> setw(dateLen+1) >> text;
74 | }
75 |
76 | Date::DaysSince(const char *text) {
77 |
78 |     int year, month, day, totDays, delim;
79 |     int daysInYear = 0;
80 |     int i;
81 |     int leap = 0;
82 |
83 |     int rc = sscanf(text, "%4d%c%2d%c%2d",
84 |                    &year, &delim, &month, &delim, &day);
85 |     --month;
86 |     if (rc != 5 || year < 0 || year > 9999 ||
87 |         month < 0 || month > 11 ||
88 |         day < 1 || day > 31 ||
89 |         (day > numDays[month] && month != 1)) {
90 |         return(-1);
91 |     }
92 |     if ((year % 4 == 0 && year % 100 != 0) || year % 400 == 0)
93 |         leap = 1;
94 |
95 |     if (month == 1 && day > numDays[month]) {
96 |         if (day > 29)
97 |             return(-1);
98 |         else if (!leap)
99 |             return (-1);
100 |     }
101 |
102 |     for (i=0; i<month> 1 || (month == 1 && day == 29))
110 |         ++daysInYear;
111 |
112 |     totDays = (curDay - daysInYear) + (curYear - year)*365;
113 |
114 |     // now, correct for leap year
115 |     for (i=year+1; i < curYear; ++i) {
116 |         if ((i % 4 == 0 && i % 100 != 0) || i % 400 == 0) {
117 |             ++totDays;
118 |         }
119 |     }
120 |     return(totDays);
121 | }

```

\* \* \* \* \* E N D O F S O U R C E \* \* \* \* \*

Figure 13. Example of a C++ compiler listing (Part 3 of 14)

```

5694A01 V1.8 z/OS XL C++          //'TSCTEST.ZOSV1R8.SCCNSAM(CCNUBRC)'          01/23/2006 18:58:17
          * * * * * I N C L U D E S * * * * *
1 = //'TSCTEST.CEEZ180.SCEEH.H(STDIO)'
2 = //'TSCTEST.CEEZ180.SCEEH.H(FEATURES)'
3 = //'TSCTEST.CEEZ180.SCEEH.SYS.H(TYPES)'
4 = //'TSCTEST.CEEZ180.SCEEH.H(STRING)'
5 = //'TSCTEST.CEEZ180.SCEEH.H(MATH)'
6 = //'TSCTEST.CEEZ180.SCEEH.H(@IEEE754)'
7 = //'TSCTEST.CEEZ180.SCEEH.H(BUILTINS)'
8 = //'TSCTEST.CEEZ180.SCEEH.H(TIME)'
9 = //'TSCTEST.CEEZ180.SCEEH.IOSTREAM)'
10 = //'TSCTEST.CEEZ180.SCEEH.ISTREAM)'
11 = //'TSCTEST.CEEZ180.SCEEH.OSTREAM)'
12 = //'TSCTEST.CEEZ180.SCEEH.H(YVALS)'
13 = //'TSCTEST.CEEZ180.SCEEH.IOS)'
14 = //'TSCTEST.CEEZ180.SCEEH.XLOCNUM)'
15 = //'TSCTEST.CEEZ180.SCEEH(CERRNO)'
16 = //'TSCTEST.CEEZ180.SCEEH.H(ERRNO)'
17 = //'TSCTEST.CEEZ180.SCEEH(CLIMITS)'
18 = //'TSCTEST.CEEZ180.SCEEH.H(LIMITS)'
19 = //'TSCTEST.CEEZ180.SCEEH(CSTDIO)'
20 = //'TSCTEST.CEEZ180.SCEEH(CSTDLIB)'
21 = //'TSCTEST.CEEZ180.SCEEH.H(STDLIB)'
22 = //'TSCTEST.CEEZ180.SCEEH(STREAMBU)'
:
          * * * * * E N D O F I N C L U D E S * * * * *

```

Figure 13. Example of a C++ compiler listing (Part 4 of 14)

```

5694A01 V1.8 z/OS XL C++          //'TSCTEST.ZOSV1R8.SCCNSAM(CCNUBRC)'          01/23/2006 18:58:17
          * * * * * C R O S S R E F E R E N C E L I S T I N G * * * * *
__valist          :
1:134 (D)        1:137 (R)
__abs             :
21:357 (R)       21:438 (R)
__absd           :
5:1055(R)        5:1135(R)
__acos           :
5:1041(R)        5:1138(R)
__acosf          :
5:1056(R)        5:1137(R)
__acosl          :
5:1057(R)        5:1139(R)
__amrc_type      :
1:924 (D)        1:928 (R)
__amrctype       :
1:858 (D)        1:924 (R)
:
          * * * * * E N D O F C R O S S R E F E R E N C E L I S T I N G * * * * *

5694A01 V1.8 z/OS XL C++          //'TSCTEST.ZOSV1R8.SCCNSAM(CCNUBRC)'          01/23/2006 18:58:17
          * * * * * M E S S A G E S U M M A R Y * * * * *
TOTAL  UNRECOVERABLE  SEVERE      ERROR      WARNING  INFORMATIONAL
      (U)            (S)            (E)        (W)        (I)
      0              0              0          0          0
          * * * * * E N D O F M E S S A G E S U M M A R Y * * * * *

```

Figure 13. Example of a C++ compiler listing (Part 5 of 14)

## Inline Report (Summary)

```
Reason:  P : noline was specified for this routine
         F : inline was specified for this routine
         C : compact was specified for this routine
         M : This is an inline member routine
         A : Automatic inlining
         - : No reason
Action:  I : Routine is inlined at least once
         L : Routine is initially too large to be inlined
         T : Routine expands too large to be inlined
         C : Candidate for inlining but not inlined
         N : No direct calls to routine are found in file (no action)
         U : Some calls not inlined due to recursion or parameter mismatch
         - : No action
Status:  D : Internal routine is discarded
         R : A direct call remains to internal routine (cannot discard)
         A : Routine has its address taken (cannot discard)
         E : External routine (cannot discard)
         - : Status unchanged
Calls/I   : Number of calls to defined routines / Number inline
Called/I  : Number of times called / Number of times inlined
```

| Reason | Action | Status | Size (init) | Calls/I | Called/I | Name  |
|--------|--------|--------|-------------|---------|----------|---|
| A      | I      | D      | 17          | 0/0     | 3/3      | std::bad_cast::bad_cast(const char*)          |
| M      | I      | D      | 18          | 0/0     | 1/1      | std::bad_cast::bad_cast(const std::bad_cast&) |
| A      | I      | R      | 17          | 0/0     | 2/1      | std::bad_alloc::bad_alloc(const char*)        |

:

```
Mode = AUTO   Inlining Threshold = 100   Expansion Limit = 1000
```

Figure 13. Example of a C++ compiler listing (Part 6 of 14)

## Inline Report (Call Structure)

```
Defined Function : std::bad_cast::bad_cast(const char*)
Calls To        : 0
Called From(3,3) : std::_EBCDIC::_LFS_OFF::_UseFacet<std::_EBCDIC::_LFS_OFF::ctype<char>,1>::_Use(const std::_EBCDIC
::_LFS_OFF::locale&,const std::_EBCDIC::_LFS_OFF::locale::facet*&,const std::_EBCDIC::_LFS_OFF::locale
::facet*)(1,1)
                std::_EBCDIC::_LFS_OFF::_UseFacet<std::_EBCDIC::_LFS_OFF::num_put<char,std::ostreambuf_iterator<char,std
::char_traits<char> >,1>::_Use(const std::_EBCDIC::_LFS_OFF::locale&,const std::_EBCDIC::_LFS_OFF
::locale::facet*&,const std::_EBCDIC::_LFS_OFF::locale::facet*)(1,1)
                std::_EBCDIC::_LFS_OFF::_UseFacet<std::_EBCDIC::_LFS_OFF::numpunct<char>,1>::_Use(const std::_EBCDIC
::_LFS_OFF::locale&,const std::_EBCDIC::_LFS_OFF::locale::facet*&,const std::_EBCDIC::_LFS_OFF::locale
::facet*)(1,1)
```

```
Defined Function : std::bad_cast::bad_cast(const std::bad_cast&)
Calls To        : 0
Called From(1,1) : std::bad_cast::_Doraise() const(1,1)
```

:

Figure 13. Example of a C++ compiler listing (Part 7 of 14)

## Inline Report (Additional Information)

```
INFORMATIONAL CCN1052: Function std::_EBCDIC::_LFS_OFF::basic_ is (or grows) too large to be inlined.
INFORMATIONAL CCN1052: Function std::_EBCDIC::_LFS_OFF::num_pu is (or grows) too large to be inlined.
INFORMATIONAL CCN1052: Function std::_EBCDIC::_LFS_OFF::_Locin is (or grows) too large to be inlined.
INFORMATIONAL CCN1052: Function std::_EBCDIC::_LFS_OFF::basic_ is (or grows) too large to be inlined.
INFORMATIONAL CCN1052: Function std::_EBCDIC::_LFS_OFF::num_pu is (or grows) too large to be inlined.
INFORMATIONAL CCN1052: Function std::_EBCDIC::_LFS_OFF::num_pu is (or grows) too large to be inlined.
INFORMATIONAL CCN1052: Function std::_EBCDIC::_LFS_OFF::num_pu is (or grows) too large to be inlined.
INFORMATIONAL CCN1052: Function std::_EBCDIC::_LFS_OFF::num_pu is (or grows) too large to be inlined.
:
```

*Figure 13. Example of a C++ compiler listing (Part 8 of 14)*

```

OFFSET OBJECT CODE      LINE# FILE#   P S E U D O   A S S E M B L Y   L I S T I N G

Timestamp and Version Information
000000 F2F0 F0F6                =C'2006'           Compiled Year
000004 F0F1 F2F3                =C'0123'           Compiled Date MMDD
000008 F1F8 F5F8 F1F8          =C'185818'        Compiled Time HHMMSS
00000E F0F1 F0F8 F0F0          =C'010800'        Compiler Version

Timestamp and Version End

```

```

OFFSET OBJECT CODE      LINE# FILE#   P S E U D O   A S S E M B L Y   L I S T I N G

std::_EBCDIC::_LFS_OFF::basic_stream
buf<char,std::char_traits<char> >::s
putc(char)
000018                000147 | 22          DS      0D
000018 47F0 F001          000147 | 22          B      1(,r15)
00001C 01C3C5C5                CEY eyecatcher
000020 000000E0                DSA size
000024 0000C378                =A(PPA1-std::_EBCDIC::_LFS_OFF::basic_streambuf<char,std::char_tr...)
000028 90E5 D00C          000147 | 22          STM    r14,r5,12(r13)
00002C 58E0 D04C          000147 | 22          L      r14,76(,r13)
000030 4100 E0E0          000147 | 22          LA     r0,224(,r14)
000034 5500 C314          000147 | 22          CL     r0,788(,r12)
000038 4140 F04C          000147 | 22          LA     r4,76(,r15)
00003C 47D0 F03A          000147 | 22          BNH    58(,r15)
000040 58F0 C31C          000147 | 22          L      r15,796(,r12)
000044 184E                000147 | 22          LR     r4,r14
000046 05EF                000147 | 22          BALR   r14,r15
000048 00000008                =F'8'
00004C 0540                000147 | 22          BALR   r4,0
00004E 4140 4016          000147 | 22          LA     r4,22(,r4)
000052 5000 E04C          000147 | 22          ST     r0,76(,r14)
000056 9210 E000          000147 | 22          MVI    0(r14),16
00005A 50D0 E004          000147 | 22          ST     r13,4(,r14)
00005E 5800 D014          000147 | 22          L      r0,20(,r13)
000062 18DE                000147 | 22          LR     r13,r14
000064                End of Prolog

000064 5010 D0BC          000147 | 22          ST     r1,this(,r13,188)
000068 5020 D0C0          000147 | 22          ST     r2,_C(,r13,192)
00006C 5810 D0BC          000148 | 22          L      r1,this(,r13,188)
000070 5810 1020          000148 | 22          L      r1,(basic_streambuf<char,std::char_traits<char> >)._IPnext@20(,r1,32)
000074 5800 1000          000148 | 22          L      r0,(char*)(,r1,0)
000078 1200                000148 | 22          LTR    r0,r0
00007A 4780 4094          000148 | 22          BE     @28L495
00007E 5810 D0BC          000148 | 22          L      r1,this(,r13,188)
000082 5820 1020          000148 | 22          L      r2,(basic_streambuf<char,std::char_traits<char> >)._IPnext@20(,r1,32)
000086 5800 2000          000148 | 22          L      r0,(char*)(,r2,0)
00008A 5810 1030          000148 | 22          L      r1,(basic_streambuf<char,std::char_traits<char> >)._IPcnt@30(,r1,48)
00008E 5820 1000          000148 | 22          L      r2,(int)(,r1,0)
000092 1810                000148 | 22          LR     r1,r0
000094 4112 1000          000148 | 22          LA     r1,#AddressShadow(r2,r1,0)
000098 1901                000148 | 22          CR     r0,r1
00009A 47B0 4094          000148 | 22          BNL   @28L495
00009E 5810 D0BC          000193 | 22          L      r1,this(,r13,188)
0000A2 5810 1030          000193 | 22          L      r1,(basic_streambuf<char,std::char_traits<char> >)._IPcnt@30(,r1,48)
0000A6 5800 1000          000193 | 22          L      r0,(int)(,r1,0)
0000AA 0600                000193 | 22          BCTR   r0,r0
0000AC 5000 1000          000193 | 22          ST     r0,(int)(,r1,0)
0000B0 5810 D0BC          000194 | 22          L      r1,this(,r13,188)
0000B4 5810 1020          000194 | 22          L      r1,(basic_streambuf<char,std::char_traits<char> >)._IPnext@20(,r1,32)
0000B8 5820 1000          000194 | 22          L      r2,(char*)(,r1,0)
0000BC 4100 2001          000194 | 22          LA     r0,#AddressShadow(,r2,1)
0000C0 5020 D0D4          000194 | 22          ST     r2,#wtemp_55(,r13,212)
0000C4 5000 1000          000194 | 22          ST     r0,(char*)(,r1,0)
0000C8 5810 D0D4          000194 | 22          L      r1,#wtemp_55(,r13,212)
0000CC 5010 D0CC          000194 | 22          ST     r1,___2218(,r13,204)

```

Figure 13. Example of a C++ compiler listing (Part 9 of 14)

```

OFFSET OBJECT CODE      LINE# FILE#  P S E U D O  A S S E M B L Y  L I S T I N G
0000D0 5010 D0D8      000193 | 22          ST  r1,#wtemp_56(,r13,216)
0000D4 1F00          000193 | 22          SLR r0,r0
0000D6 4300 D0C3      000193 | 22          IC  r0,_C(,r13,195)
0000DA 4200 1000      000193 | 22          STC r0,(char)(,r1,0)
0000DE 5810 D0D8      000193 | 22          L   r1,#wtemp_56(,r13,216)
0000E2 5010 D0C8      000193 | 22          ST  r1,__2219(,r13,200)
0000E6 1F00          000289 | 36          SLR r0,r0
0000E8 4300 1000      000289 | 36          IC  r0,(char)(,r1,0)
0000EC 5000 D0D0      000289 | 36          ST  r0,__2221(,r13,208)
0000F0 5000 D0C4      000289 | 36          ST  r0,__2224(,r13,196)
0000F4 47F0 40C4      000289 | 36          B   @28L496
0000F8          000289 | 36          DS  @28L495 0H
0000F8 5810 D0BC      000150 | 22          L   r1,this(,r13,188)
0000FC 5830 1000      000150 | 22          L   r3,(basic_streambuf<char,std::char_traits<char> >[])@0(,r1,0)
000100 5850 3014      000150 | 22          L   r5,(long)(,r3,20)
000104 1F22          000150 | 22          SLR r2,r2
000106 4320 D0C3      000150 | 22          IC  r2,_C(,r13,195)
00010A 5830 3010      000150 | 22          L   r3,(int (*)(int))(,r3,16)
00010E 4115 1000      000150 | 22          LA  r1,#AddressShadow(r5,r1,0)
000112 58F0 3008      000150 | 22          L   r15,&Func_&WSA(,r3,8)
000116 5800 300C      000150 | 22          L   r0,&Func_&WSA(,r3,12)
00011A 4DE0 F010      000150 | 22          BAS r14,16(,r15)
00011E 4700 0008      000150 | 22          NOP 8
000122 1801          000150 | 22          LR  r0,r1
000124 5000 D0C4      000150 | 22          ST  r0,__2224(,r13,196)
000128          000150 | 22          DS  @28L496 0H
000128 5810 D0C4      000150 | 22          L   r1,__2224(,r13,196)
00012C          000150 | 22          DS  @28L1590 0H

00012C          Start of Epilog
00012C 58D0 D004      000150 | 22          L   r13,4(,r13)
000130 58E0 D00C      000150 | 22          L   r14,12(,r13)
000134 9835 D020      000150 | 22          LM  r3,r5,32(r13)
000138 47F0 E004      000150 | 22          B   4(,r14)
00013C 0707          000150 | 22          NOPR 7

*** General purpose registers used: 1111110000001111
*** Floating point registers used: 1111111100000000
*** Size of register spill area: 128(max) 0(used)
*** Size of dynamic storage: 224
*** Size of executable code: 294

```

:

Figure 13. Example of a C++ compiler listing (Part 10 of 14)

```

E X T E R N A L  S Y M B O L  D I C T I O N A R Y

TYPE  ID  ADDR      LENGTH      NAME
SD    1  000000  00F2A0      @STATICP
PR    2  000000  000738      @STATIC
PR    3  000000  000004      dateLen_4Date
PR    4  000000  000004      numMonths_4Date
PR    5  000000  000004      pCycle_9BioRhythm
PR    6  000000  000004      eCycle_9BioRhythm
PR    7  000000  000004      iCycle_9BioRhythm
PR    8  000000  000030      numDays_4Date
PR    9  000000  000004      _Psave_use_facet_Q3_3std7_EBCDIC8_LFS_OFFH04_3std7_EBCDIC8_LFS_OFF7num
      _putXTcTQ2_3std19ostreambuf_iterator
      XTcTQ2_3std11char_traitsXTc_____RCQ4_
      3std7_EBCDIC8_LFS_OFF61ocale_RCQ4_3s
      td7_EBCDIC8_LFS_OFF7num_putXTcTQ2_3s
      td19ostreambuf_iteratorXTcTQ2_3std11
      char_traitsXTc_____2
PR   10 000000  000004      id_Q4_3std7_EBCDIC8_LFS_OFF7num_put
      XTcTQ2_3std19ostreambuf_iteratorXTcT
      Q2_3std11char_traitsXTc_____

```

:

Figure 13. Example of a C++ compiler listing (Part 11 of 14)

## EXTERNAL SYMBOL CROSS REFERENCE

| ORIGINAL NAME                | EXTERNAL SYMBOL NAME                 |
|------------------------------|--------------------------------------|
| @STATICP                     | @STATICP                             |
| @STATIC                      | @STATIC                              |
| Date::dateLen                | dateLen__4Date                       |
| Date::numMonths              | numMonths__4Date                     |
| BioRhythm::pCycle            | pCycle__9BioRhythm                   |
| BioRhythm::eCycle            | eCycle__9BioRhythm                   |
| BioRhythm::iCycle            | iCycle__9BioRhythm                   |
| Date::numDays                | numDays__4Date                       |
| const std::_EBCDIC::_LFS_OFF | _Psave__use_facet__Q3_3std7_EBCDIC8_ |

:

Figure 13. Example of a C++ compiler listing (Part 12 of 14)

## \*\*\*\*\* STORAGE OFFSET LISTING \*\*\*\*\*

| IDENTIFIER | DEFINITION | ATTRIBUTES<br><SEQNBR>--<FILE NO>:<FILE LINE NO> |                      |             |
|------------|------------|--|----------------------|-------------|
| code       | 23-0:23    | Class = automatic,                               | Location = 228(r13), | Length = 4  |
| bio        | 22-0:22    | Class = automatic,                               | Location = 192(r13), | Length = 24 |
| newTime    | 57-0:57    | Class = automatic,                               | Location = 204(r13), | Length = 4  |
| lTime      | 56-0:56    | Class = automatic,                               | Location = 200(r13), | Length = 4  |
| newTime    | 57-0:57    | Class = automatic,                               | Location = 208(r13), | Length = 4  |
| lTime      | 56-0:56    | Class = automatic,                               | Location = 204(r13), | Length = 4  |
| birthText  | 67-0:67    | Class = parameter,                               | Location = 192(r13), | Length = 4  |
| newTime    | 57-0:57    | Class = automatic,                               | Location = 212(r13), | Length = 4  |
| lTime      | 56-0:56    | Class = automatic,                               | Location = 208(r13), | Length = 4  |
| totDays    | 78-0:78    | Class = automatic,                               | Location = 260(r13), | Length = 4  |
| i          | 80-0:80    | Class = automatic,                               | Location = 256(r13), | Length = 4  |
| :          |            |  |                      |             |
| :          |            |  |                      |             |

\*\*\*\*\* END OF STORAGE OFFSET LISTING \*\*\*\*\*

Figure 13. Example of a C++ compiler listing (Part 13 of 14)

```

          * * * * * S T A T I C   M A P   * * * * *

OFFSET (HEX)  LENGTH (HEX)  NAME
      0             4      time
      4             4      localtime
      8             4      cout__Q3_3std7_EBCDIC8_LFS_OFF
      C             4      asctime
     10             4      endl__Q3_3std7_EBCDIC8_LFS_OFFHcQ2_3std11char_traitsXTc__RQ4_3std7_EBCDIC8_LFS_OFF13
                        basic_ostream
                        Q2_3std11char_traitsXTc__RQ4_3std7_EBCDIC8_LFS_OFF13basic_ostreamXTcTQ2_3std11
                        char_traitsXTc__
     14             4      setw__Q3_3std7_EBCDIC8_LFS_OFFFi
     18             4      cin__Q3_3std7_EBCDIC8_LFS_OFF
     1C             4      cerr__Q3_3std7_EBCDIC8_LFS_OFF
     20             4      __fmod
     24             4      __sin
     28             4      sscanf
     2C             4      numDays__4Date
     30             4      __ct__Q2_3std7_LockitFi
     34             4      __Id_cnt__Q5_3std7_EBCDIC8_LFS_OFF6locale2id
     38             4      __dt__Q2_3std7_LockitFv
     3C             4      __Getfacet__Q4_3std7_EBCDIC8_LFS_OFF6localeCFUi
     40             4      cclear__Q4_3std7_EBCDIC8_LFS_OFF8ios_baseFib
:
          * * * * * E N D   O F   S T A T I C   M A P   * * * * *
          * * * * * E N D   O F   C O M P I L A T I O N   * * * * *

```

Figure 13. Example of a C++ compiler listing (Part 14 of 14)

## z/OS XL C++ compiler listing components

The following sections describe the components of a C++ compiler listing. These are available for regular and IPA compilations. Differences in the IPA versions of the listings are noted. “Using the IPA Link step listing” on page 271 describes IPA-specific listings.

### Heading information

The first page of the listing is identified by the product number, the compiler version and release numbers, the name of the data set or z/OS UNIX System Services file containing the source code, the date and time compilation began (formatted according to the current locale), and the page number.

**Note:** If the name of the data set or z/OS UNIX file that contains the source code is greater than 32 characters, it is truncated. Only the right-most 32 characters appear in the listing.

### Prolog section

The Prolog section provides information about the compile-time library, file identifiers, compiler options, and other items in effect when the compiler was invoked.

All options except those with no default (for example, DEFINE) are shown in the listing. Any problems with the compiler options appear after the body of the Prolog section.

**IPA considerations:** If you specify IPA suboptions that are irrelevant to the IPA Compile step, the Prolog does not display them. If IPA processing is not active, IPA suboptions do not appear in the Prolog.



The following sections describe the optional parts of the listing and the compiler options that generate them.

### Source Program

If you specify the SOURCE option, the listing file includes input to the compiler.

**Note:** If you specify the SHOWINC option, the source listing shows the included text after the #include directives.

### Cross-Reference Listing

The XREF option generates a cross-reference table that contains a list of the identifiers from the source program. The table also displays a list of reference, modification, and definition information for each identifier.

The ATTR option generates a cross-reference table that contains a list of the identifiers from the source program, with a list of attributes for each identifier.

If you specify both ATTR and XREF, the cross-reference listing is a composite of the two forms. It contains the list of identifiers, as well as the attribute and reference, modification, and definition information for each identifier. The list is in the form:

```
identifier : attribute  
           n:m (x)
```

where:

- n corresponds to the file number from the INCLUDE LIST. If the identifier is from the main program, n is 0.
- m corresponds to the line number in the file *n*.
- x is the cross reference code. It takes one of the following values:
  - R - referenced
  - D - defined
  - M - modified

together with the line numbers in which they appear.

### Includes section

The compiler generates the Includes section when you use include files, and specify the options SOURCE, LIST, or INLRPT.

### Messages

If the preprocessor or the compiler detects an error, or the possibility of an error, it generates messages. If you specify the SOURCE compiler option, preprocessor error messages appear immediately after the source statement in error. You can generate your own messages in the preprocessing stage by using #error. For information on #error, see the *z/OS XL C/C++ Language Reference*.

If you specify the compiler options FLAG(I), CHECKOUT or INFO(), the compiler will generate informational diagnostic messages.

For a description of compiler messages, see *z/OS XL C/C++ Messages*.

### Message Summary

This listing section displays the total number of messages and the number of messages for each severity level.

## Inline Report

If the OPTIMIZE and INLRPT options are specified, an Inline Report will be included in the listing. This report contains an inline summary and a detailed call structure.

**Note:** No report is produced when your source file contains only one defined subprogram.

The summary contains information such as:

- Name of each defined subprogram. Subprogram names appear in alphabetical order.
- Reason for action on a subprogram:
  - The P indicates that **#pragma noline** and the COMPACT compiler option are not in effect.
  - The F indicates that the subprogram was declared inline, either by **#pragma inline** for C or the `inline` keyword for C++.
  - The C indicates that the COMPACT compiler option is specified for **#pragma\_override(FuncName,"OPT(COMPACT,yes)"** is specified in the source code.
  - The M indicates that C++ routine is an inline member routine.
  - The A indicates automatic inlining acted on the subprogram.
  - The - indicates there was no reason to inline the subprogram.
- Action on a subprogram:
  - Subprogram was inlined at least once.
  - Subprogram was not inlined because of initial size constraints.
  - Subprogram was not inlined because of expansion beyond size constraint.
  - Subprogram was a candidate for inlining, but was not inlined.
  - Subprogram was a candidate for inlining, but was not referenced.
  - This subprogram is directly recursive, or some calls have mismatching parameters

Note: The "Called" and "Calls" in the actions section of the inline report, indicate how many times a function has been called or has called other functions, despite whether or not the callers or callees have been inlined.

- Status of original subprogram after inlining:
  - Subprogram is discarded because it is no longer referenced and is defined as `static internal`.
  - Subprogram was not discarded for various reasons :
    - Subprogram is external. (It can be called from outside the compilation unit.)
    - Some call to this subprogram remains.
    - Subprogram has its address taken.
- Initial relative size of subprogram (in Abstract Code Units (ACU)).
- Final relative size of subprogram (in ACUs) after inlining.
- Number of calls within the subprogram and the number of these calls that were inlined into the subprogram.
- Number of times the subprogram is called by others in the compile unit and the number of times this subprogram was inlined.
- Mode that is selected and the value of *threshold* and *limit* specified for this compilation.

The detailed call structure contains specific information of each subprogram such as:

- What subprograms it calls
- What subprograms call it

- In which subprograms it is inlined.

The information can help you to better analyze your program if you want to use the inliner in selective mode.

There may be additional messages as a result of the inlining. For example, if inlining a subprogram with automatic storage increases the automatic storage of the subprogram it is being inlined into by more than 4K, a message is emitted.

### **Pseudo Assembly Listing**

The LIST compiler option generates a listing of the machine instructions in the object module in a form similar to assembler language.

This Pseudo Assembly listing displays the source statement line numbers and the line number of any inlined code to aid you in debugging inlined code.

### **External Symbol Dictionary**

The LIST compiler option generates the External Symbol Dictionary. The External Symbol Dictionary lists the names that the compiler generates for the output object module. It includes address information and size information about each symbol.

### **External Symbol Cross Reference**

The ATTR or XREF compiler options generate the External Symbol Cross Reference section. It shows the original name and corresponding mangled name for each symbol. For additional information on mangled names, see Chapter 14, “Filter utility,” on page 449.

### **Storage Offset Listing**

If you specify the XREF option, the listing file includes offset information on identifiers.

### **Static Map**

Static Map displays the contents of the @STATIC data area, which holds the file scope read/write static variables. It displays the offset (as a hexadecimal number), the length (as a hexadecimal number), and the names of the objects mapped to @STATIC. Under certain circumstances, the compiler may decide to map other objects to @STATIC.

If you specify the ATTR or XREF option, the listing file includes offset information for file scope read/write static variables.

---

## **Using the IPA Link step listing**

The IPA Link step generates a listing file if you specify any of the following options:

- ATTR
- INLINE(,REPORT,,)
- INLRPT
- IPA(MAP)
- LIST
- XREF

**Note:** IPA does not support source listings or source annotations within Pseudo Assembly listings. The Pseudo Assembly listings do display the file and line number of the source code that contributed to a segment of pseudo assembly code.

# Example of an IPA Link step listing

Figure 14 shows an example of an IPA Link step listing.

```

5694-A01 V1.8 z/OS XL C/C++ IPA                               DD:SYSIN                               02/28/2006 11:31:59   Page   1

      * * * * * P R O L O G * * * * *

Compile Time Library . . . . . : 41080000
Command options:
  Primary input name. . . . . : DD:SYSIN
  Compiler options. . . . . : *IPA(LINK,MAP,NOREFMAP,LEVEL(1),DUP,ER,NONCAL,NOUPCASE,NOPDF1,NOPDF2,NOPDFNAME,NOCONTROL)
                             : *NOGONUMBER *NOHOT *NOALIAS *TERMINAL *LIST *XREF *NOATTR
                             : *NOOFFSET *MEMORY *NOCSECT *LIBANSI *FLAG(1)
                             : *NOTEST(NOSYM,NOBLOCK,NOLINE,NOPATH,HOOK) *OPTIMIZE(2)
                             : *INLINE(AUTO,REPORT,1000,8000) *OPTFILE(DD:OPTION) *NOSERVICE *NOOE
                             : *NOLOCALE *HALT(16) *NOGOFF

      * * * * * E N D   O F   P R O L O G * * * * *

5694-A01 V1.8 z/OS XL C/C++ IPA                               DD:SYSIN                               02/28/2006 11:31:59   Page   2

      * * * * * O B J E C T   F I L E   M A P * * * * *

*ORIGIN IPA FILE ID FILE NAME
  P      1 USERID1.DEFECT.CNTL(INCLCNTL)
  PI     Y  2 USERID1.DEFECT.PASS1.OBJECT(INCLMAIN)
  PI     Y  3 USERID1.DEFECT.PASS1.OBJECT(INCLRTN1)
  PI     Y  4 USERID1.DEFECT.PASS1.OBJECT(INCLRTN2)

ORIGIN: P=primary input   PI=primary INCLUDE   SI=secondary INCLUDE   IN=internal
        A=automatic call  U=UPCASE automatic call R=RENAME card       L=C Library

      * * * * * E N D   O F   O B J E C T   F I L E   M A P * * * * *

5694-A01 V1.8 z/OS XL C/C++ IPA                               DD:SYSIN                               02/28/2006 11:31:59   Page   3

      * * * * * C O M P I L E R   O P T I O N S   M A P * * * * *

SOURCE FILE ID    COMPILER OPTIONS
  1
  *AGGRCOPY(NOOVERLAP) *NOALIAS *ANSIALIAS *ARCH(5) *ARGPARSE
  *CHARSET(BIAS=EBCDIC,LIB=EBCDIC) *NOCOMPACT *NOCOMPRESS *NODLL(NOCALLBACKANY) *ENV(MVS)
  *EXECOPS *FLOAT(HEX,FOLD,AFP) *NOGONUMBER *NOIGNERRNO *ILP32 *NOINITAUTO
  *IPA(NOLINK,NOOBJECT,COMPRESS) *NOLIBANSI *NOLIST *NOLOCALE *LONGNAME
  *MAXMEM(2097152) *OPTIMIZE(2) *PLIST(HOST) *REDIR *NORENT *NOROCONST *SPILL(128)
  *NOSTART *STRICT *NOSTRICT_INDUCTION *NOTEST *TUNE(5) *NOXPLINK *NOXREF

  2
  *AGGRCOPY(NOOVERLAP) *NOALIAS *ANSIALIAS *ARCH(5) *ARGPARSE
  *CHARSET(BIAS=EBCDIC,LIB=EBCDIC) *NOCOMPACT *NOCOMPRESS *NODLL(NOCALLBACKANY) *ENV(MVS)
  *EXECOPS *FLOAT(HEX,FOLD,AFP) *NOGONUMBER *NOIGNERRNO *ILP32 *NOINITAUTO
  *IPA(NOLINK,NOOBJECT,COMPRESS) *NOLIBANSI *NOLIST *NOLOCALE *LONGNAME
  *MAXMEM(2097152) *OPTIMIZE(2) *PLIST(HOST) *REDIR *NORENT *NOROCONST *SPILL(128)
  *NOSTART *STRICT *NOSTRICT_INDUCTION *NOTEST *TUNE(5) *NOXPLINK *NOXREF

  3
  *AGGRCOPY(NOOVERLAP) *NOALIAS *ANSIALIAS *ARCH(5) *ARGPARSE
  *CHARSET(BIAS=EBCDIC,LIB=EBCDIC) *NOCOMPACT *NOCOMPRESS *NODLL(NOCALLBACKANY) *ENV(MVS)
  *EXECOPS *FLOAT(HEX,FOLD,AFP) *NOGONUMBER *NOIGNERRNO *ILP32 *NOINITAUTO
  *IPA(NOLINK,NOOBJECT,COMPRESS) *NOLIBANSI *NOLIST *NOLOCALE *LONGNAME
  *MAXMEM(2097152) *OPTIMIZE(2) *PLIST(HOST) *REDIR *NORENT *NOROCONST *SPILL(128)
  *NOSTART *STRICT *NOSTRICT_INDUCTION *NOTEST *TUNE(5) *NOXPLINK *NOXREF

      * * * * * E N D   O F   C O M P I L E R   O P T I O N S   M A P * * * * *

```

Figure 14. Example of an IPA Link step listing (Part 1 of 7)

\*\*\*\*\* INLINE REPORT \*\*\*\*\*

IPA Inline Report (Summary)

Reason: P : #pragma noline was specified for this routine  
 F : #pragma inline was specified for this routine  
 A : Automatic inlining  
 C : Partition conflict  
 N : Not IPA Object  
 - : No reason

Action: I : Routine is inlined at least once  
 L : Routine is initially too large to be inlined  
 T : Routine expands too large to be inlined  
 C : Candidate for inlining but not inlined  
 N : No direct calls to routine are found in file (no action)  
 U : Some calls not inlined due to recursion or parameter mismatch  
 - : No action

Status: D : Internal routine is discarded  
 R : A direct call remains to internal routine (cannot discard)  
 A : Routine has its address taken (cannot discard)  
 E : External routine (cannot discard)  
 - : Status unchanged

Calls/I : Number of calls to defined routines / Number inline  
 Called/I : Number of times called / Number of times inlined

| Reason | Action | Status | Size (init) | Calls/I | Called/I | Name      |
|--------|--------|--------|-------------|---------|----------|-----------|
| A      | N      | -      | 200 (102)   | 11/11   | 0        | main      |
| A      | I      | D      | 0 (18)      | 0       | 1/1      | Incl_Rtn1 |
| A      | I      | D      | 0 (8)       | 0       | 10/10    | Incl_Rtn2 |

Mode = AUTO      Inlining Threshold = 1000      Expansion Limit = 8000

IPA Inline Report (Call Structure)

Defined Subprogram : main  
 Calls To(11,11) : Incl\_Rtn2(10,10)  
                   Incl\_Rtn1(1,1)  
 Called From : 0

Defined Subprogram : Incl\_Rtn2  
 Calls To : 0  
 Called From(10,10) : main(10,10)

Defined Subprogram : Incl\_Rtn1  
 Calls To : 0  
 Called From(1,1) : main(1,1)

\*\*\*\*\* END OF INLINE REPORT \*\*\*\*\*

Figure 14. Example of an IPA Link step listing (Part 2 of 7)

\*\*\*\*\* PARTITION MAP \*\*\*\*\*

PARTITION 1 OF 1

PARTITION SIZE:

Actual: 50900  
Limit: 1572864

PARTITION CSECT NAMES:

Code: none  
Static: none  
Test: none

PARTITION DESCRIPTION:

Additional partition

COMPILER OPTIONS FOR PARTITION 1:

|                      |             |            |            |             |                                  |             |
|----------------------|-------------|------------|------------|-------------|----------------------------------|-------------|
| *AGGRCOPY(NOOVERLAP) | *NOALIAS    | *ARCH(5)   | *ARGPARSE  | *ATTR       | *CHARSET(BIAS=EBCDIC,LIB=EBCDIC) | *NOCOMPACT  |
| *NOCOMPRESS          | *NOCSECT    | *NODLL     | *ENV(MVS)  | *EXECOPS    | *FLOAT(HEX,FOLD,AFP)             | *NOGIGNERNO |
| *ILP32               | *NOINITAUTO | *IPA(LINK) | *LIBANSI   | *LIST       | *NOLOCALE                        | *LONGNAME   |
| *PLIST(HOST)         | *REDIR      | *NORENT    | *NOROCONST | *SPILL(128) | *START                           | *STRICT     |
| *TUNE(5)             | *NOXPLINK   | *XREF      |            |             |                                  |             |

SYMBOLS IN PARTITION 1:

| *TYPE | FILE ID | SYMBOL |
|-------|---------|--------|
| D     | 1       | gb1    |
| F     | 1       | main   |

TYPE: F=function D=data

SOURCE FILES FOR PARTITION 1:

| *ORIGIN | FILE ID | SOURCE FILE NAME               |
|---------|---------|--------------------------------|
| P       | 1       | //'USERID1.DEFECT.C(INCLMAIN)' |
| P       | 2       | //'USERID1.DEFECT.C(INCLRTN1)' |
| P       | 3       | //'USERID1.DEFECT.C(INCLRTN2)' |

ORIGIN: P=primary input PI=primary INCLUDE

\*\*\*\*\* END OF PARTITION MAP \*\*\*\*\*

Figure 14. Example of an IPA Link step listing (Part 3 of 7)

```

OFFSET OBJECT CODE      LINE# FILE#  P S E U D O  A S S E M B L Y  L I S T I N G
Timestamp and Version Information
000000 F2F0 F0F6                =C'2006'          Compiled Year
000004 F0F2 F2F8                =C'0228'          Compiled Date MMDD
000008 F1F1 F3F1 F5F0          =C'113150'        Compiled Time HHMMSS
00000E F0F1 F0F8 F0F0          =C'010800'        Compiler Version
Timestamp and Version End

```

```

OFFSET OBJECT CODE      LINE# FILE#  P S E U D O  A S S E M B L Y  L I S T I N G
000018                000010 | 1 main DS 0D
000018 47F0 F022          000010 | 1 B 34(,r15)
00001C 01C3C5C5          CEE eyecatcher
000020 00000098          DSA size
000024 00000098          =A(PPA1-main)
000028 47F0 F001          000010 | 1 B 1(,r15)
00002C 58F0 C31C          000010 | 1 L r15,796(,r12)
000030 184E                000010 | 1 LR r4,r14
000032 05EF                000010 | 1 BALR r14,r15
000034 00000000          =F'0'
000038 07F3                000010 | 1 BR r3
00003A 90E4 D00C          000010 | 1 STM r14,r4,12(r13)
00003E 58E0 D04C          000010 | 1 L r14,76(,r13)
000042 4100 E098          000010 | 1 LA r0,152(,r14)
000046 5500 C314          000010 | 1 CL r0,788(,r12)
00004A 4130 F03A          000010 | 1 LA r3,58(,r15)
00004E 4720 F014          000010 | 1 BH 20(,r15)
000052 5000 E04C          000010 | 1 ST r0,76(,r14)
000056 9210 E000          000010 | 1 MVI 0(r14),16
00005A 50D0 E004          000010 | 1 ST r13,4(,r14)
00005E 18DE                000010 | 1 LR r13,r14
000060                End of Prolog

000060 180F                000008 | 3 + LR r0,r15
000062 8900 0001          000008 | 3 + SLL r0,1
000066 181F                000008 | 3 + LR r1,r15
000068 B252 0010          000008 | 3 + MSR r1,r0
00006C 180F                000008 | 3 + LR r0,r15
00006E B252 0001          000008 | 3 + MSR r0,r1
000072 181F                000008 | 3 + LR r1,r15
000074 B252 0010          000008 | 3 + MSR r1,r0
000078 180F                000008 | 3 + LR r0,r15
00007A B252 0001          000008 | 3 + MSR r0,r1
00007E 181F                000008 | 3 + LR r1,r15
000080 B252 0010          000008 | 3 + MSR r1,r0
000084 180F                000008 | 3 + LR r0,r15
000086 B252 0001          000008 | 3 + MSR r0,r1
00008A 181F                000008 | 3 + LR r1,r15
00008C B252 0010          000008 | 3 + MSR r1,r0
000090 180F                000008 | 3 + LR r0,r15
000092 B252 0001          000008 | 3 + MSR r0,r1
000096 B252 00F0          000008 | 3 + MSR r15,r0
00009A                000022 | 1 @1L18 DS 0H

00009A                Start of Epilog
00009A 180D                000023 | 1 LR r0,r13
00009C 58D0 D004          000023 | 1 L r13,4(,r13)
0000A0 58E0 D00C          000023 | 1 L r14,12(,r13)
0000A4 9824 D01C          000023 | 1 LM r2,r4,28(r13)
0000A8 051E                000023 | 1 BALR r1,r14
0000AA 0707                000023 | 1 NOPR 7

*** General purpose registers used: 1101100000001111
*** Floating point registers used: 0000000000000000
*** Size of register spill area: 128(max) 0(used)
*** Size of dynamic storage: 152

```

Figure 14. Example of an IPA Link step listing (Part 4 of 7)

```

OFFSET OBJECT CODE      LINE#  FILE#   P S E U D O   A S S E M B L Y   L I S T I N G
*** Size of executable code: 148

```

```

OFFSET OBJECT CODE      LINE#  FILE#   P S E U D O   A S S E M B L Y   L I S T I N G

PPA1: Entry Point Constants

0000B0 1CCEA106           =F'483303686'      Flags
0000B4 000000D8           =A(PPA2-main)
0000B8 00000000           =F'0'              No PPA3
0000BC 00000000           =F'0'              No EPD
0000C0 FE000000           =F'-33554432'     Register save mask
0000C4 00000000           =F'0'              Member flags
0000C8 90                 =AL1(144)          Flags
0000C9 000000           =AL3(0)            Callee's DSA use/8
0000CC 0040              =H'64'             Flags
0000CE 0012              =H'18'             Offset/2 to CDL
0000D0 00000000           =F'0'              Reserved
0000D4 5000004A           =F'1342177354'    CDL function length/2
0000D8 FFFFFFF68          =F'-152'           CDL function EP offset
0000DC 38240000           =F'941883392'     CDL prolog
0000E0 40090041           =F'1074331713'    CDL epilog
0000E4 00000000           =F'0'              CDL end
0000E8 0004 ****         AL2(4),C'main'

PPA1 End

PPA2: Compile Unit Block

0000F0 0300 2202           =F'50340354'      Flags
0000F4 FFFF FF10           =A(CEESTART-PPA2)
0000F8 0000 0000           =F'0'              No PPA4
0000FC FFFF FF10           =A(TIMESTAMP-PPA2)
000100 0000 0000           =F'0'              No primary
000104 0000 0000           =F'0'              Flags

PPA2 End

```

Figure 14. Example of an IPA Link step listing (Part 5 of 7)



EXTERNAL SYMBOL DICTIONARY

| TYPE | ID | ADDR   | LENGTH | NAME     |
|------|----|--------|--------|----------|
| SD   | 1  | 000000 | 000108 | @STATICP |
| PC   | 2  | 000000 | 000004 |          |
| LD   | 0  | 000018 | 000001 | main     |
| ER   | 3  | 000000 |        | CEESG003 |
| ER   | 4  | 000000 |        | CEESTART |
| SD   | 5  | 000000 | 000008 | @PPA2    |
| SD   | 6  | 000000 | 00000C | CEEMAIN  |
| ER   | 7  | 000000 |        | EDCINPL  |

EXTERNAL SYMBOL CROSS REFERENCE

| ORIGINAL NAME | EXTERNAL SYMBOL NAME |
|---------------|----------------------|
| @STATICP      | @STATICP             |
| __STAT__      |                      |
| main          | main                 |
| CEESG003      | CEESG003             |
| CEESTART      | CEESTART             |
| @PPA2         | @PPA2                |
| CEEMAIN       | CEEMAIN              |
| EDCINPL       | EDCINPL              |

\*\*\*\*\* STATIC MAP \*\*\*\*\*

| OFFSET (HEX) | LENGTH (HEX) | NAME |
|--------------|--------------|------|
| 0            | 4            | gb1  |

\*\*\*\*\* END OF STATIC MAP \*\*\*\*\*

Figure 14. Example of an IPA Link step listing (Part 6 of 7)

\*\*\*\*\* SOURCE FILE MAP \*\*\*\*\*

| *ORIGIN | OBJECT FILE ID | SOURCE FILE ID | SOURCE FILE NAME  |
|---------|----------------|----------------|---|
| P       | 2              | 1              | //'USERID1.DEFECT.C(INCLMAIN)'<br>- Compiled by 15694A01 1800<br>on 02/28/2006 11:31:50   |
| P       | 3              | 2              | //'USERID1.DEFECT.C(INCLRTN1)'  |
| P       | 4              | 3              | -' Compiled by 15694A01 1800<br>on 02/28/2006 11:31:53<br>//'USERID1.DEFECT.C(INCLRTN2)'<br>- Compiled by 15694A01 1800<br>on 02/28/2006 11:31:56 |

ORIGIN: P=primary input PI=primary INCLUDE

\*\*\*\*\* END OF SOURCE FILE MAP \*\*\*\*\*

\*\*\*\*\* MESSAGE SUMMARY \*\*\*\*\*

| TOTAL | UNRECOVERABLE (U) | SEVERE (S) | ERROR (E) | WARNING (W) | INFORMATIONAL (I) |
|-------|-------------------|------------|-----------|-------------|-------------------|
| 0     | 0                 | 0          | 0         | 0           | 0                 |

\*\*\*\*\* END OF MESSAGE SUMMARY \*\*\*\*\*

\*\*\*\*\* END OF COMPILATION \*\*\*\*\*

Figure 14. Example of an IPA Link step listing (Part 7 of 7)

## IPA Link step listing components

The following sections describe the components of an IPA Link step listing.

## Heading information

The first page of the listing is identified by the product number, the compiler version and release numbers, the central title area, the date and time compilation began (formatted according to the current locale), and the page number.

In the following listing sections, the central title area will contain the primary input file identifier:

- Prolog
- Object File Map
- Source File Map
- Compiler Options Map
- Global Symbols Map
- Inline Report
- Messages
- Message Summary

In the following listing sections, the central title area will contain the phrase Partition nnnn, where nnnn specifies the partition number:

- Partition Map

In the following listing sections, the title contains the phrase Partition nnnn:name. nnnn specifies the partition number, and name specifies the name of the first function in the partition:

- Pseudo Assembly Listing
- External Symbol Cross Reference
- Storage Offset Listing

## Prolog section

The Prolog section of the listing provides information about the compile-time library, file identifiers, compiler options, and other items in effect when the IPA Link step was invoked.

The listing displays all compiler options except those with no default (for example, DEFINE). If you specify IPA suboptions that are irrelevant to the IPA Link step, the Prolog does not display them. Any problems with compiler options appear after the body of the Prolog section and before the End of Prolog section.

## Object File Map

The Object File Map displays the names of the object files that were used as input to the IPA Link step. Specify any of the following options to generate the Object File Map:

- IPA(MAP)
- LIST

Other listing sections, such as the Source File Map, use the File ID numbers that appear in this listing section.

z/OS UNIX System Services file names that are too long to fit into a single listing record continue on subsequent listing records.

## Source File Map

The Source File Map listing section identifies the source files that are included in the object files. The IPA Link step generates this section if you specify any of the following options:

- IPA(MAP)

- LIST

The IPA Link step formats the compilation date and time according to the locale you specify with the LOCALE option in the IPA Link step. If you do not specify the LOCALE option, it uses the default locale.

This section appears near the end of the IPA Link step listing. If the IPA Link step terminates early due to errors, it does not generate this section.

### **Compiler Options Map**

The Compiler Options Map listing section identifies the compiler options that were specified during the IPA Compile step for each compilation unit that is encountered when the object file is processed. For each compilation unit, it displays the final options that are relevant to IPA Link step processing. You may have specified these options through a compiler option or #pragma directive, or you may have picked them up as defaults.

The IPA Link step generates this listing section if you specify the IPA(MAP) option.

### **Global Symbols Map**

The Global Symbols Map listing section shows how global symbols are mapped into members of global data structures by the global variable coalescing optimization process.

Each global data structure is limited to 16 MB by the z/OS object architecture. If an application has more than 16 MB of data, IPA Link must generate multiple global data structures for the application. Each global data structure is assigned a unique name.

The Global Symbols Map includes symbol information and file name information (file name information may be approximate). In addition, line number information is available for C compilations if you specified any of the following options during the IPA Compile step:

- XREF
- IPA(XREF)
- XREF(ATTRIBUTE)

The IPA Link step generates this listing section if you specify the IPA(MAP) option and the IPA Link step causes global symbols to be coalesced. The Global Symbols Map is only added to the IPA Link step listing if the IPA Link phase optimization changes the structure and/or layout of the global symbols utilized by the final module. If no changes are made, then the Global Symbols Map is not included in the listing.

### **Inline Report for IPA inliner**

The Inline Report describes the actions that are performed by the IPA Inliner. The IPA Link step generates this listing section if you specify the INLINE(,REPORT,,), NOINLINE(,REPORT,,), or INLRPT option.

This report is similar to the one that is generated by the non-IPA inliner. In the IPA version of this report, the term 'subprogram' is equivalent to a C/C++ function or a C++ method. The summary contains information such as:

- Name of each defined subprogram. IPA sorts subprogram names in alphabetical order.
- Reason for action on a subprogram:

- A **#pragma noline** was specified for the subprogram. The P indicates that inlining could not be performed.
- `inline` was specified for the subprogram. For z/OS XL C++, this is a result of the inline specifier. For C, this a result of the **#pragma inline**. The F indicates that the subprogram was declared inline.
- The IPA Link step performed auto-inlining on the subprogram.
- There was no reason to inline the subprogram.
- There was a partition conflict.
- The IPA Link step could not inline the object module because it was a non-IPA object module.
- Action on a subprogram:
  - IPA inlined subprogram at least once.
  - IPA did not inline subprogram because of initial size constraints.
  - IPA did not inline subprogram because of expansion beyond size constraint.
  - Subprogram was a candidate for inlining, but IPA did not inline it.
  - Subprogram was a candidate for inlining, but was not referenced.
  - The subprogram is directly recursive, or some calls have mismatched parameters.
- Status of original subprogram after inlining:
  - IPA discarded the subprogram because it is no longer referenced and is defined as `static internal`.
  - IPA did not discard the subprogram, for various reasons :
    - Subprogram is external. (It can be called from outside the compilation unit.)
    - Subprogram call to this subprogram remains.
    - Subprogram has its address taken.
- Initial relative size of subprogram (in Abstract Code Units (ACUs)).
- Final relative size of subprogram (in ACUs) after inlining.
- Number of calls within the subprogram and the number of these calls that IPA inlined into the subprogram.
- Number of times the subprogram is called by others in the compile unit and the number of times IPA inlined the subprogram.
- Mode that is selected and the value of *threshold* and *limit* you specified for the compilation.

Static functions whose names are not unique within the application as a whole will have names prefixed with `nnnn:`, where `nnnn` is the source file number.

The detailed call structure contains specific information of each subprogram such as:

- Subprograms that it calls
- Subprograms that call it
- Subprograms in which it is inlined.

The information can help you to better analyze your program if you want to use the inliner in selective mode.

Inlining may result in additional messages. For example, if inlining a subprogram with automatic storage increases the automatic storage of the subprogram it is being inlined into by more than 4K, the IPA Link step issues a message.

This report may display information about inlining specific subprograms, at the point at which IPA determines that inlining is impossible.

The counts in this report do not include calls from non-IPA to IPA programs.

**Note:** Even if the IPA Link step did not perform any inlining, it generates the IPA Inline Report if you request it.

## Partition Map

The Partition Map listing section describes each of the object code partitions the IPA Link step creates. It provides the following information:

- The reason for generating each partition
- How the code is packaged (the CSECTs)
- The options used to generate the object code
- The function and global data included in the partition
- The source files that were used to create the partition

The IPA Link step generates this listing section if you specify either of the following options :

- IPA(MAP)
- LIST

The Pseudo Assembly, External Symbol Dictionary, External Symbol Cross Reference, and Storage Offset listing sections follow the Partition Map listing section for the partition, if you have specified the appropriate compiler options.

## Pseudo Assembly Listing

The LIST compiler option generates a listing of the machine instructions in the current partition of the object module, in a form similar to assembler language.

This Pseudo Assembly listing displays the source statement line numbers and the line number of inlined code to aid you in debugging inlined code. Refer to “GONUMBER | NOGONUMBER” on page 111, “IPA | NOIPA” on page 124, and “LIST | NOLIST” on page 146 for information about source and line numbers in the listing section.

## External Symbol Dictionary

The External Symbol Dictionary lists the names that the IPA Link step generates for the current partition of the object module. It includes address information and size information about each symbol.

## External Symbol Cross Reference

The IPA Link step generates this section if you specify the ATTR or XREF compiler option. It shows how the IPA Link step maps internal and ESD names for external symbols that are defined or referenced in the current partition of the object module.

## Storage Offset Listing

The Storage Offset listing section displays the offsets for the data in the current partition of the object module.

During the IPA Compile step, the compiler saves symbol storage offset information in the IPA object file as follows:

- For C, if you specify the XREF, IPA(ATTRIBUTE), IPA(XREF) options, or the **#pragma options(XREF)**
- For C++, if you specify the ATTR, XREF, IPA(ATTRIBUTE), or IPA(XREF) options

If this is done and the compilation unit includes variables, the IPA Link step may generate a Storage Offset listing.

If you specify the ATTR or XREF option on the IPA Link step, and any of the compilation units that contributed variables to a particular partition had storage

offset information encoded in the IPA object file, the IPA Link step generates a Storage Offset listing section for that partition.

The Storage Offset listing displays the variables that IPA did not coalesce. The symbol definition information appears as `file#:line#`.

### Static Map

If you specify the ATTR or XREF option, the listing file includes offset information for file scope read/write static variables.

### Messages

If the IPA Link step detects an error, or the possibility of an error, it issues one or more diagnostic messages, and generates the Messages listing section. This listing section contains a summary of the messages that are issued during IPA Link step processing.

The IPA Link step listing sorts the messages by severity. The Messages listing section displays the listing page number where each message was originally shown. It also displays the message text, and optionally, information relating the error to a file name, line (if known), and column (if known).

For more information on compiler messages, see “FLAG | NOFLAG” on page 105, and *z/OS XL C/C++ Messages*.

### Message Summary

This listing section displays the total number of messages and the number of messages for each severity level.

The following tables show the components that are included in the listing depending on which option is specified:

Table 30. IPA Link step listing components

| Listing Component               | W1, I, ATTR | -W1, I, INLINE (, REPORT ,,) | -W1, I, INLRPT (des tina tion) | -W1, I, IPA (MAP) | -W1, I, LIST (des tina tion) | -W1, I, XREF | -V | Phase    |
|---------------------------------|-------------|------------------------------|--------------------------------|-------------------|------------------------------|--------------|----|----------|
| Compiler Options Map            |             |                              |                                | ✓                 |                              |              | ✓  | IPA Link |
| Cross-Reference Table           |             |                              |                                |                   |                              |              | ✓  | Binder   |
| Entry Point and Alias Summary   |             |                              |                                |                   |                              |              | ✓  | Binder   |
| External Symbol Cross-Reference | ✓           |                              |                                |                   |                              | ✓            | ✓  | Backend  |
| External Symbol Dictionary      |             |                              |                                |                   | ✓                            |              | ✓  | Backend  |

Table 30. IPA Link step listing components (continued)

| Listing Component             | W1, I, ATTR | -W1, I, INLINE (, REPORT ,) | -W1, I, INLRPT (destination) | -W1, I, IPA (MAP) | -W1, I, LIST (destination) | -W1, I, XREF | -V | Phase    |
|-------------------------------|-------------|-----------------------------|------------------------------|-------------------|----------------------------|--------------|----|----------|
| Global Symbols Map **         |             |                             |                              | ✓                 |                            |              | ✓  | IPA Link |
| Imported and Exported Symbols |             |                             |                              |                   |                            |              | ✓  | Binder   |
| Inline Report                 |             | ✓                           | ✓                            |                   |                            |              |    | IPA Link |
| Input List                    |             |                             |                              |                   |                            |              | ✓  | Binder   |
| Message Summary               | ✓           | ✓                           | ✓                            | ✓                 | ✓                          | ✓            | ✓  | IPA Link |
| Message Summary Report        |             |                             |                              |                   |                            |              | ✓  | Binder   |
| Messages *                    | ✓           | ✓                           | ✓                            | ✓                 | ✓                          | ✓            | ✓  | IPA Link |
| Module Map                    |             |                             |                              |                   |                            |              | ✓  | Binder   |
| Object File Map               |             |                             |                              | ✓                 |                            |              | ✓  | IPA Link |
| Partition Map                 |             |                             |                              | ✓                 |                            |              | ✓  | IPA Link |
| Processing Options            |             |                             |                              |                   |                            |              | ✓  | Binder   |
| Prolog                        | ✓           | ✓                           | ✓                            | ✓                 | ✓                          | ✓            | ✓  | IPA Link |
| Pseudo Assembly Listing       |             |                             |                              |                   | ✓                          |              | ✓  | Backend  |
| Save Module Attributes        |             |                             |                              |                   |                            |              | ✓  | Binder   |
| Save Operation Summary        |             |                             |                              |                   |                            |              | ✓  | Binder   |
| Source File Map               |             |                             |                              | ✓                 |                            |              | ✓  | IPA Link |
| Storage Offset Listing        |             |                             |                              |                   |                            |              | ✓  | Backend  |

\* This section is only generated if diagnostic messages are issued.

\*\* This section is only generated if the IPA Link phase coalesces global variables.





---

## Chapter 5. Binder options and control statements

This chapter lists the binder options, suboptions, and control statements that are considered important for a C or C++ programmer. For a detailed description of all the binder options and control statements, see *z/OS MVS Program Management: User's Guide and Reference*.

C or C++ programmers should be familiar with the following binder options and relevant suboptions:

- ALIASES
- AMODE
- CALL
- CASE
- COMPAT
- DYNAM
- LET
- LIST
- MAP
- OPTIONS
- REUS
- RMODE
- UPCASE
- XREF

C or C++ programmers should be familiar with the following control statements:

- AUTOCALL
- ENTRY
- IMPORT
- INCLUDE
- LIBRARY
- NAME
- RENAME



---

## Chapter 6. Run-Time options

This chapter describes how to specify run-time options and **#pragma runopts** preprocessor directives available to you with z/OS XL C/C++ and z/OS Language Environment. For a detailed description of the z/OS Language Environment run-time options and information about how to apply them in different environments, refer to *z/OS Language Environment Programming Reference*.

---

### Specifying run-time options

To allow your application to recognize run-time options, either the EXECOPS compiler option, or the **#pragma runopts(execops)** directive must be in effect. The default compiler option is EXECOPS.

You can specify run-time options as follows:

- At execution time in one of the following ways:
  - On the GPARM option of the IBM-supplied cataloged procedures
  - On the option list of the TSO CALL command
  - On the PARM parameter of the EXEC PGM=*your-program-name* JCL statement
  - On the exported `_CEE_RUNOPTS` environment variable under the z/OS shell
- At compile time, on a **#pragma runopts** directive in your main program

If EXECOPS is in effect, use a slash '/' to separate run-time options from arguments that you pass to the application. For example:

```
GPARM= ' STORAGE (FE, FE, FE) / PARM1, PARM2, PARM3 '
```

If EXECOPS is in effect, Language Environment interprets the character string that precedes the slash as run-time options. It passes the character string that follows the slash to your application as arguments. If no slash separates the arguments, Language Environment interprets the entire string as an argument.

If EXECOPS is not in effect, Language Environment passes the entire string to your application.

If you specify two or more contradictory options (for example in a **#pragma runopts** statement), the last option that is encountered is accepted. Run-time options that you specify at execution time have higher precedence than those specified at compile time.

For more information on the precedence and specification of run-time options for applications that are compiled with z/OS Language Environment, refer to *z/OS Language Environment Programming Reference*.

### Using the **#pragma runopts** preprocessor directive

You can use the **#pragma runopts** preprocessor directive to specify z/OS Language Environment run-time options. You can also use **#pragma runopts** to specify the run-time options ARGPARSE, ENV, PLIST, REDIR, and EXECOPS, which have matching compiler options. If you specify the compiler option, it takes precedence over the **#pragma runopts** directive.

When the run-time option EXECOPS is in effect, you can specify run-time options at execution time, as previously described. These options override run-time options that you compiled into the program by using the **#pragma runopts** directive.

You can specify multiple run-time options per directive or multiple directives per compilation unit. If you want to specify the ARGPARSE or REDIR options, the **#pragma runopts** directive must be in the same compilation unit as `main()`. Neither run-time option has an effect on programs invoked under the z/OS shell. This is because the shell program handles the parsing and redirection of command line arguments within that environment. Even though you can specify this directive in multiple compilation units, the specification that will take effect depends on the order of linking. It is advisable to specify it only once, and in the same compilation unit as `main()`.

When you specify multiple instances of **#pragma runopts** in separate compilation units, the compiler generates a CSECT for each compilation unit that contains a **#pragma runopts** directive. When you link multiple compilation units that specify **#pragma runopts**, the linkage editor takes only the first CSECT, thereby ignoring your other option statements. Therefore, you should always specify your **#pragma runopts** directive in the same source file that contains the function `main()`.

For more information on the **#pragma runopts** preprocessor directive, see *z/OS XL C/C++ Language Reference*.

---

## Part 3. Compiling, binding, and running z/OS XL C/C++ programs

This part describes how to compile, bind, and run z/OS XL C/C++ programs using z/OS Language Environment in the following sections:

- Chapter 7, “Compiling,” on page 291
- Chapter 8, “Using the IPA Link step with z/OS XL C/C++ programs,” on page 329
- Chapter 9, “Binding z/OS XL C/C++ programs,” on page 355
- Chapter 10, “Binder processing,” on page 383
- Chapter 11, “Running a C or C++ application,” on page 409
- Chapter 12, “Cataloged procedures and REXX EXECs,” on page 419



---

## Chapter 7. Compiling

This chapter describes how to compile your program with the z/OS XL C/C++ compiler and z/OS Language Environment. For specific information about compiler options, see Chapter 4, “Compiler Options,” on page 45.

The z/OS XL C/C++ compiler analyzes the source program and translates the source code into machine instructions that are known as *object code*.

You can perform compilations under z/OS batch, TSO, or the z/OS UNIX System Services environment.

**Note:** As of z/OS V1R5 C/C++, the compiler will only work if both the SCEERUN and SCEERUN2 Language Environment libraries are available.

---

### Input to the z/OS XL C/C++ compiler

The following sections describe how to specify input to the z/OS XL C/C++ compiler for a regular compilation, or the IPA Compile step. For more information about input for IPA, refer to Chapter 8, “Using the IPA Link step with z/OS XL C/C++ programs,” on page 329.

If you are compiling a C or C++ program, input for the compiler consists of the following:

- Your z/OS XL C/C++ source program
- The z/OS XL C/C++ standard header files including IBM-supplied Class Library header files
- Your header files

When you invoke the z/OS XL C/C++ compiler, the operating system locates and runs the compiler. To run the compiler, you need the following default data sets, which are supplied by IBM:

- CBC.SCCNCMP
- CEE.SCEERUN
- CEE.SCEERUN2

The locations of the compiler and the run-time library were determined by the system programmer who installed the product. The compiler and library should be in the STEPLIB, JOBLIB, LPA, or LNKLST concatenations. LPA can be from either specific modules (IEALPaxx) or a list (LPALSTxx). See the cataloged procedures shipped with the product in Chapter 12, “Cataloged procedures and REXX EXECs,” on page 419.

**Note:** For z/OS UNIX System Services file names, unless they appear in JCL, file names, which contain the special characters blank, backslash, and double quote, must escape these characters. The escape character is backslash (\).

### Primary input

For a C or C++ program, the primary input to the compiler is the data set that contains your XL C/C++ source program. If you are running the compiler in batch, identify the input source program with the SYSIN DD statement. You can do this by either defining the data set that contains the source code or by placing your source code directly in the JCL stream. In TSO or in z/OS UNIX System Services, identify the input source program by name as a command line argument. The primary input source file can be any one of the following:

- A sequential data set
- A member of a partitioned data set
- All members of a partitioned data set
- A z/OS UNIX file
- All files in a z/OS UNIX directory

## Secondary input

For a C or C++ program, secondary input to the compiler consists of data sets or directories that contain include files. Use the LSEARCH and SEARCH compiler options, or the SYSLIB DD statement when compiling in batch, to specify the location of the include files.

For more information on the use of these compiler options, see “LSEARCH | NOLSEARCH” on page 153 and “SEARCH | NOSEARCH” on page 183. For more information on naming include files, see “Specifying include file names” on page 317. For information on how the compiler searches for include files, see “Search sequences for include files” on page 325. For more information on include files, refer to “Using include files” on page 316.

**Note:** The LRECL for the SCLBH.H data set has changed from 80 to 120. You should ensure that SCLBH.H is the first data set in your SYSLIB concatenation. Do not use the SYSLIB concatenation to search for C++ header files with the compiler because searching the SYSLIB concatenation cannot distinguish between the old UNIX System Laboratories header files and new ISO Standard Library header files. For example, `#include <iostream.h>` (old USL) and `#include <iostream>` (ISO Standard) are indistinguishable using the SYSLIB concatenation. Use the SEARCH compiler option so that the correct header files are included.

---

## Output from the compiler

You can specify compiler output files as one or more of the following:

- A sequential data set
- A member of a partitioned data set
- A partitioned data set
- A z/OS UNIX file
- A z/OS UNIX directory

For valid combinations of input file types and output file types, refer to Table 33 on page 295.

## Specifying output files

You can use compile options to specify compilation output files as follows:

Table 31. Compile options that provide output file names

| Output File Type    | Compiler Option   |
|---------------------|---|
| Object Module       | OBJECT( <i>filename</i> )   |
| Listing File        | SOURCE( <i>filename</i> ), LIST( <i>filename</i> ), INLRPT( <i>filename</i> ) (Note: All listings must go to the same file. The last given location is used.) |
| Preprocessor Output | PPONLY( <i>filename</i> )   |
| Events File         | EVENTS( <i>filename</i> )   |
| Template Output     | TEMPINC( <i>location</i> )  |



Table 31. Compile options that provide output file names (continued)

| Output File Type  | Compiler Option                     |
|-------------------|-------------------------------------|
| Template Registry | TEMPLATEREGISTRY( <i>filename</i> ) |

When compiler options that generate output files are specified without suboptions to identify the output files, and, in the case of a batch job, the designated ddnames are not allocated, the output file names are generated based on the name of the source file.

**Note:** The exception to this case is Template Registry, which is fixed to `templreg`, and Template Output, which is fixed to `tempinc`.

For data sets, the compiler generates a low-level qualifier by appending a suffix to the data set name of the source, as Table 32 shows.

If you compile source from z/OS UNIX System Services files without specifying output file names in the compiler options, the compiler writes the output files to the current working directory. The compiler does the following to generate the output file names:

- Appends a suffix, if it does not exist
- Replaces the suffix, if it exists

The following default suffixes are used:

Table 32. Defaults for output file types

| Output File Type    | z/OS File | z/OS UNIX File |
|---------------------|-----------|----------------|
| Object Module       | OBJ       | o              |
| Listing File        | LIST      | lst            |
| Preprocessor Output | EXPAND    | i              |
| Template Output     | TEMPINC   | ./tempinc      |
| Template Registry   | TEMPLREG  | ./templreg     |

**Notes:**

1. Output files default to the z/OS UNIX directory if the source resides in the z/OS UNIX file system, or to an MVS data set if the source resides in a data set.
2. If you have specified the OE option, see “OE | NOOE” on page 165 for a description of the default naming convention.
3. If you supply inline source in your JCL, the compiler will not generate an output file name automatically. You can specify a file name either as a suboption for a compiler option, or on a ddname in your JCL.
4. If you are using **#pragma options** to specify a compile-time option that generates an output file, you must use a ddname to specify the output file name when compiling under batch. The compiler will not automatically generate file names for output that is created by **#pragma options**.

**Example:** Under TSO, the compiler generates the object file `userid.TEST.SRC.OBJ` if you compile the following:

```
cc TEST.SRC (OBJ)
```

The compiler generates the object file `userid.TEST.SRC.OBJ(HELLO)` if you compile the following:

```
cc 'h1qua1.TEST.SRC(HELLO)' (OBJ)
```

## Listing output

**Note:** Although the compiler listing is for your use, it is not a programming interface and is subject to change.

To create a listing file that contains source, object, or inline reports use the SOURCE, LIST, or INLRPT compile options, respectively. The listing includes the results of the default or specified options of the CPARM parameter (that is, the diagnostic messages and the object code listing). If you specify *filename* with two or more of these compile options, the compiler combines the listings and writes them to the last file specified in the compile options. If you did not specify *filename*, the listing will go to the SYSCPRT DD name, if you allocated it. Otherwise, the compiler generates a default file name as described in “LIST | NOLIST” on page 146.

## Object module output

To create an object module and store it on disk or tape, you can use the OBJECT compiler option.

If you do not specify *filename* with the OBJECT option, the compiler stores the object code in the file that you define in the SYSLIN DD statement. If you do not specify *filename* with the OBJECT option, and did not allocate SYSLIN, the compiler generates a default file name, as described in “OBJECT | NOOBJECT” on page 163.

Under z/OS UNIX System Services, an object name specified with **-o** will take priority over the file name specified with the OBJECT option.

**Differences in object modules under IPA:** The format of the object module generated by a regular compile may differ from that generated by an IPA Compile, depending on the IPA suboption setting. If it is set to OBJONLY, then they have the same format. If it is set to OBJECT, then the object module will contain an IPA object in addition to the traditional object code and associated symbolic information. If NOOBJECT is specified, then only the IPA object is written to the object module. The IPA Link phase reads the IPA object code from the input object modules. It is the only process which can do so. Therefore, if you attempt to bind an IPA object file that was created by using the IPA(NOLINK,NOOBJECT) option, then the binder issues an error message and the bind will fail.

Refer to “Valid input/output file types” on page 295 for information about valid input/output file types.

## Preprocessor output

If you specify *filename* with the PPNLY compile option, the compiler writes the preprocessor output to that file. If you do not specify *filename* with the PPNLY option, the compiler stores the preprocessor output in the file that you define in the SYSUT10 DD statement. If you did not allocate SYSUT10, the compiler generates a default file name, as described in “PPONLY | NOPPNLY” on page 175.

## Template instantiation output

If you specify *location*, which is either a z/OS UNIX file or a sequential file (or PDS member), with the TEMPLATEREGISTRY compile option, the compiler writes the template registry to that location. If you do not specify *location* with the TEMPLATEREGISTRY option, the compiler determines a default destination for the template registry file. See “TEMPLATEREGISTRY | NOTEMPLATEREGISTRY” on page 205 for more information on this default.

If you specify *location*, which is either a z/OS UNIX directory or a PDS, with the TEMPINC compile option, the compiler writes the template instantiation output to that location. If you do not specify *location* with the TEMPINC option, the compiler stores the TEMPINC output in the file that is associated with the TEMPINC DD name. If you did not allocate DD:TEMPINC, the compiler determines a default destination for the template instantiation files. See “TEMPINC | NOTEMPINC” on page 203 for more information on this default.

## Valid input/output file types

Depending on the type of file that is used as primary input, certain output file types are allowed. The following table describes these combinations of input and output files:

Table 33. Valid combinations of source and output file types

| Input Source File   | Output Data Set Specified Without (member) Name, for example A.B.C   | Output Data Set Specified as filename(member), for example A.B.C(D)  | Output Specified as a z/OS UNIX file, for example a/b/c.o   | Output Specified as a z/OS UNIX directory, for example a/b   |
|---|--|--|---|--|
| <b>Sequential Data Set, for example A.B</b>                 | <ol style="list-style-type: none"> <li>1. If the file exists as a sequential data set, overwrites it</li> <li>2. If the file does not exist, creates sequential data set</li> <li>3. Otherwise compilation fails</li> </ol>                          | <ol style="list-style-type: none"> <li>1. If the PDS does not exist, creates PDS and member</li> <li>2. If the PDS exists and member does not exist, adds member</li> <li>3. If the PDS and member both exist, then overwrites the member</li> </ol> | <ol style="list-style-type: none"> <li>1. If the directory does not exist, compilation fails</li> <li>2. If the directory exists but the file does not exist, creates file</li> <li>3. If the file exists, overwrites the file</li> </ol>   | Not supported  |
| <b>A member of a PDS using (member), for example A.B(C)</b> | <ol style="list-style-type: none"> <li>1. If the file exists as a sequential data set, overwrites it</li> <li>2. If the file exists as a PDS, creates or overwrites member</li> <li>3. If the file does not exist, creates PDS and member</li> </ol> | <ol style="list-style-type: none"> <li>1. If the PDS does not exist, creates PDS and member</li> <li>2. If the PDS exists and member does not exist, adds member</li> <li>3. If the PDS and member both exist, then overwrites the member</li> </ol> | <ol style="list-style-type: none"> <li>1. If the directory does not exist, compilation fails</li> <li>2. If the directory exists and the file with the specified file name does not exist, creates file</li> <li>3. If the directory exists and the file exists, overwrites file</li> </ol> | <ol style="list-style-type: none"> <li>1. If the directory does not exist, compilation fails</li> <li>2. If the directory exists and the file with the file name <i>MEMBER.ext</i> does not exist, creates file</li> <li>3. If the directory exists and the file with the file name <i>MEMBER.ext</i> also exists, overwrite file</li> </ol> |

Table 33. Valid combinations of source and output file types (continued)

| Input Source File                            | Output Data Set Specified Without (member) Name, for example A.B.C  | Output Data Set Specified as filename(member), for example A.B.C(D)   | Output Specified as a z/OS UNIX file, for example a/b/c.o   | Output Specified as a z/OS UNIX directory, for example a/b  |
|--|---|---|---|---|
| <b>All members of a PDS, for example A.B</b> | <ol style="list-style-type: none"> <li>1. If the file exists as a PDS, creates or overwrites members</li> <li>2. If the file does not exist, creates PDS and members</li> <li>3. Otherwise compilation fails</li> </ol>       | Not Supported   | Not Supported   | <ol style="list-style-type: none"> <li>1. If the directory does not exist, compilation fails</li> <li>2. If the directory exists and the files with the file names <i>MEMBER.ext</i> do not exist, creates files</li> <li>3. If the directory exists and the files with the file names <i>MEMBER.ext</i> exist, overwrites files</li> </ol> |
| <b>z/OS UNIX file, for example /a/b/d.c</b>  | <ol style="list-style-type: none"> <li>1. If the file exists as a sequential data set, overwrites file</li> <li>2. If the file does not exist, creates sequential data set</li> <li>3. Otherwise compilation fails</li> </ol> | <ol style="list-style-type: none"> <li>1. If the PDS does not exist, creates the PDS and stores a member into the data set</li> <li>2. If the PDS exists and member does not exist, then adds the member in the PDS</li> <li>3. If the PDS and member both exist, then overwrites the member</li> </ol> | <ol style="list-style-type: none"> <li>1. If the directory does not exist, compilation fails</li> <li>2. If the directory exists but the file does not exist, creates file</li> <li>3. If the file exists, overwrites the file</li> </ol> | <ol style="list-style-type: none"> <li>1. If the directory does not exist, compilation fails</li> <li>2. If the directory exists and the file does not exist, creates file</li> <li>3. If the directory exists and the file exists, overwrites file</li> </ol>  |
| <b>z/OS UNIX directory, for example a/b/</b> | Not supported   | Not supported   | Not supported   | <ol style="list-style-type: none"> <li>1. If the directory does not exist, compilation fails</li> <li>2. If the directory exists and the files to be written do not exist, creates files</li> <li>3. If the directory exists and the files to be written already exist, overwrites files</li> </ol>   |

## Compiling under z/OS batch

To compile your C/C++ source program under batch, you can either use cataloged procedures that IBM supplies, or write your own JCL statements.

## Using cataloged procedures for z/OS XL C

You can use one of the following IBM-supplied cataloged procedures. Each procedure includes a compilation step to compile your program.

**EDCC** Compile a 31-bit or 64-bit program

**EDCCB**

Compile and bind a 31-bit program

**EDXCBC**

Compile and bind a 31-bit XPLINK C program

**EDCQCB**

Compile and bind a 64-bit C program

**EDCCL**

Compile and link-edit a 31-bit naturally re-entrant program

**EDCCBG**

Compile, bind, and run a 31-bit program

**EDXCBCG**

Compile, bind, and run a 31-bit XPLINK C program

**EDCQCBG**

Compile, bind, and run a 64-bit C program

**EDCCLG**

Compile, link-edit, and run a 31-bit program

**EDCCPLG**

Compile, prelink, link-edit, and run a 31-bit program

**EDCCLIB**

Compile and maintain an object library for a 31-bit or 64-bit application

### IPA considerations

The EDCC procedure should be used for the IPA Compile step. Only the EDCI and EDCXI procedures apply to the IPA Link step. For information on the EDCI and EDCXI procedures, see Chapter 8, “Using the IPA Link step with z/OS XL C/C++ programs,” on page 329.

To run the IPA Compile step, use the EDCC procedure, and ensure that you specify the IPA(NOLINK) or IPA compiler option. Note that you must also specify the LONGNAME compiler option or the **#pragma longname** directive.

To create an IPA-optimized object module, you must run the IPA Compile step for each source file in your program, and the IPA Link step once for the entire program. Once you have successfully created an IPA-optimized object module, you must bind it to create the final executable.

For further information on IPA, see Chapter 8, “Using the IPA Link step with z/OS XL C/C++ programs,” on page 329.

## Using cataloged procedures for z/OS XL C++

You can use one of the following cataloged procedures that IBM supplies. Each procedure includes a compilation step to compile your program.

**CBCC** Compile a 31-bit or 64-bit program

**CBCCB** Compile and bind a 31-bit non-XPLINK program

**CBCXCB** Compile and bind a 31-bit XPLINK C++ program

**CBCQCB** Compile and bind a 64-bit C++ program

|                |   |
|----------------|---|
| <b>CBCCL</b>   | Compile, prelink, and link for a 31-bit non-XPLINK program  |
| <b>CBCCBG</b>  | Compile, bind, and run a 31-bit non-XPLINK program          |
| <b>CBCXCBG</b> | Compile, bind, and run a 31-bit XPLINK C++ program          |
| <b>CBCQCBG</b> | Compile, bind, and run a 64-bit C++ program                 |
| <b>CBCCLG</b>  | Compile, prelink, link, and run a 31-bit non-XPLINK program |

See Chapter 12, “Cataloged procedures and REXX EXECs,” on page 419 for more information on cataloged procedures.

### IPA considerations

The CBCC procedure should be used for the IPA Compile step. Only the CBCI and CBCXI procedures apply to the IPA Link step. For information on the CBCI and CBCXI procedures, see Chapter 8, “Using the IPA Link step with z/OS XL C/C++ programs,” on page 329.

To run the IPA Compile step, use the CBCC procedure, and ensure that you specify the IPA(NOLINK) or IPA compiler option. Note that for C you must also specify the LONGNAME compiler option or the **#pragma longname** directive. For C++, you don't have to do this since C++ always uses LONGNAME. You should not specify the NOLONGNAME option.

To create an IPA-optimized object module, you must run the IPA Compile step for each source file in your program, and the IPA Link step once for the entire program. Once you have successfully created an IPA-optimized object module, you must bind it to create the final executable.

For further information on IPA, see Chapter 8, “Using the IPA Link step with z/OS XL C/C++ programs,” on page 329.

---

## Using special characters

When invoking the compiler directly, if a string contains a single quote (') it should be written as two single quotes (') as in:

```
//COMPILE EXEC PGM=CCNDRVR,PARM='OPTFILE(''USERID.OPTS'')
```

If you are using the same string to pass a parameter to a cataloged procedure, use four single quotes (''''), as follows:

```
//COMPILE EXEC CBCC,CPARM='''OPTFILE(''USERID.OPTS'')'''
```

A backslash need not precede special characters in z/OS UNIX System Services file names that you use in DD cards. For example:

```
//SYSLIN DD PATH='/u/user1/obj 1.o'
```

A backslash must precede special characters in z/OS UNIX file names that you use in the PARM statement. For example:

```
//STEP1 EXEC PGM=CCNDRVR,PARM='/u/user1/obj\ 1.o'
```

---

## Examples of compiling programs using your own JCL

The following example shows sample JCL for compiling a 32-bit C program:

```

//jobname JOB acctno,name...
//COMPILE EXEC PGM=CCNDVR,
// PARM='/SEARCH(''CEE.SCEEH.'') NOOPT SO OBJ'
//STEPLIB DD DSN=CEE.SCEERUN,DISP=SHR
// DD DSN=CEE.SCEERUN2,DISP=SHR
// DD DSN=CBC.SCCNCMP,DISP=SHR
//SYSLIN DD DSN=MYID.MYPROG.OBJ(MEMBER),DISP=SHR
//SYSPRINT DD SYSOUT=*
//SYSIN DD DATA,DLM=@@
#include <stdio.h>
:
:
int main(void)
{
/* comment */
:
}
@@
//SYSUT1 DD DSN=...
:
:
//*/

```

Figure 15. JCL for compiling a 32-bit C program (for NOOPT, SOURCE, and OBJ)

The following example shows sample JCL for compiling a 64-bit C program:

```

//jobname JOB acctno,name...
//COMPILE EXEC PGM=CCNDVR,
// PARM='/SEARCH(''CEE.SCEEH.'') NOOPT SO LP64 OPTFILE(DD:CPATH)'
//STEPLIB DD DSN=CEE.SCEERUN,DISP=SHR
// DD DSN=CEE.SCEERUN2,DISP=SHR
// DD DSN=CBC.SCCNCMP,DISP=SHR
//SYSLIN DD DSN=MYID.MYPROG.OBJ(MEMBER),DISP=SHR
//SYSPRINT DD SYSOUT=*
//SYSIN DD DATA,DLM=@@
#include <stdio.h> ...
int main(void)
{
/* comment */
:
}
@@
//SYSUT1 DD DSN=...
:
:
//*/

```

Figure 16. JCL for compiling a 64-bit C program (for NOOPT, SOURCE, and LP64)

The following example shows sample JCL for compiling a 32-bit C++ program:

```

//jobname JOB acctno,name...
//COMPILE EXEC PGM=CCNDRVR,
// PARM='/CXX SEARCH(''CEE.SCEEH.'', ''CBC.SCLBH.''),NOOPT,SO,OBJ'
//STEPLIB DD DSN=CEE.SCEERUN,DISP=SHR
//          DD DSN=CEE.SCEERUN2,DISP=SHR
//          DD DSN=CBC.SCCNCMP,DISP=SHR
//SYSLIN DD DSN=MYID.MYPROJ.OBJ,DISP=SHR
//SYSPRINT DD SYSOUT=*
//SYSIN DD DATA,DLM=@@
#include <stdio.h>
#include <iostream.h>
:
int main(void)
{
// comment
:
}
@@
//SYSUT1 DD DSN=...
:
/*

```

Figure 17. JCL for compiling a 32-bit C++ program (for NOOPT, SOURCE, and OBJ)

The following example shows sample JCL for compiling a 64-bit C++ program:

```

//jobname JOB acctno,name...
//COMPILE EXEC PGM=CCNDRVR,
// PARM='/CXX SEARCH(''CEE.SCEEH.'', ''CBC.SCLBH.''),NOOPT,SO,LP64'
//STEPLIB DD DSN=CEE.SCEERUN,DISP=SHR
//          DD DSN=CEE.SCEERUN2,DISP=SHR
//          DD DSN=CBC.SCCNCMP,DISP=SHR
//SYSLIN DD DSN=MYID.MYPROJ.OBJ,DISP=SHR
//SYSPRINT DD SYSOUT=*
//SYSIN DD DATA,DLM=@@
#include <stdio.>
#include <iostream.h> ...
int main(void)
{
// comment
:
}
@@
//SYSUT1 DD DSN=...
:
/*

```

Figure 18. JCL for compiling a 64-bit C++ program (for NOOPT, SOURCE, and LP64)

---

## Specifying source files

For non-z/OS UNIX System Services files, use this format of the SYSIN DD statement:

```
//SYSIN DD DSNAME=dsname,DISP=SHR
```

If you specify a PDS without a member name, all members of that PDS are compiled.

**Note:** If you specify a PDS as your primary input, you must specify either a PDS or a z/OS UNIX directory for your output files.



For z/OS UNIX files, use this format of the SYSIN DD statement:

```
//SYSIN DD PATH='pathname'
```

You can specify compilation for a single file or all source files in a z/OS UNIX directory, for example:

```
//SYSIN DD PATH='/u/david'  
//* All files in the directory /u/david are compiled
```

**Note:** If you specify a z/OS UNIX directory as your primary input, you must specify a z/OS UNIX directory for your output files.

When you place your source code directly in the input stream, use the following form of the SYSIN DD statement:

```
//SYSIN DD DATA,DLM=
```

rather than:

```
//SYSIN DD *
```

When you use the DD \* convention, the first XL C/C++ comment statement that starts in column 1 will terminate the input to the compiler. This is because /\*, the beginning of a C or C++ comment, is also the default delimiter.

**Note:** To treat columns 73 through 80 as sequence numbers, use the SEQUENCE compiler option.

For more information about the DD \* convention, refer to the publications that are listed in *z/OS Information Roadmap*.

---

## Specifying include files

**Example:** Use the SEARCH option to specify system include files, and the LSEARCH option to specify your include files:

```
//C EXEC PGM=CCNDVR,PARM='/CXX SEARCH(''CEE.SCEEH.+'',''CBC.SCLBH.+'')
```

You can also use the SYSLIB and USERLIB DD statements (note that the SYSLIB DD statement has a different use if you are running the IPA Link step). To specify more than one library, concatenate multiple DD statements as follows:

```
//SYSLIB DD DSNAME=USERLIB,DISP=SHR  
// DD DSNAME=DUPX,DISP=SHR
```

**Note:** If the concatenated data sets have different block sizes, either specify the data set with the largest block size first, or use the DCB=*dsname* subparameter on the first DD statement. For example:

```
//USERLIB DD DSNAME=TINYLIB,DISP=SHR,DCB=BIGLIB  
// DD DSNAME=BIGLIB,DISP=SHR
```

where BIGLIB has the largest block size. For rules regarding concatenation of data sets in JCL, refer to *z/OS XL C/C++ Programming Guide*.

---

## Specifying output files

You can specify output file names as suboptions to the compiler. You can direct the output to a PDS member as follows:

```
// CPARAM='LIST(MY.LISTINGS(MEMBER1))'
```

You can direct the output to a z/OS UNIX System Services file as follows:

```
// CPARAM='LIST(./listings/member1.lst)'
```

You can also use DD statements to specify output file names.

To specify non-z/OS UNIX files, use DD statements with the DSNNAME parameter. For example:

```
//SYSLIN DD DSN=USERID.TEST.OBJ(HELLO),DISP=SHR
```

To specify z/OS UNIX directories or z/OS UNIX files, use DD statements with the PATH parameter.

```
//SYSLIN DD PATH='/u/david/test.o',PATHOPTS=(OWRONLY,OCREAT,OTRUNC)
```

**Note:** Use the PATH and PATHOPTs parameters when specifying z/OS UNIX files in the DD statements. For additional information on these parameters, refer to the list of publications in *z/OS Information Roadmap*.

If you do not specify the output *filename* as a suboption, and do not allocate the associated ddname, the compiler generates a default output file name. There are two situations when the compiler will not generate a default file name:

- You supply instream source in your JCL.
- You are using **#pragma options** to specify a compile-time option that generates an output file.

---

## Compiling under TSO

You can invoke the z/OS XL C/C++ compiler under TSO by foreground execution from TSO READY. This method of foreground execution calls the CC or CXX REXX EXECs supplied by IBM.

**Note:** To run the compiler under TSO, you must have access to the run-time libraries. To ensure that you have access to the run-time library and compiler, do one of the following:

- Have your system programmer add the libraries to the LPALST or LPA
- Have your system programmer add the libraries to the LNKLST
- Have your system programmer change the LOGON PROC so the libraries are added to the STEPLIB for the TSO session
- Have your system programmer customize the REXX EXEC CCNCCUST, which is called by the CC, CXX, and other EXECs to set up the environment

## Using the CC and CXX REXX EXECs

You can use the CC REXX EXEC to invoke the z/OS XL C compiler, and the CXX REXX EXEC to invoke the z/OS XL C++ compiler. These REXX EXECs share the same syntax:

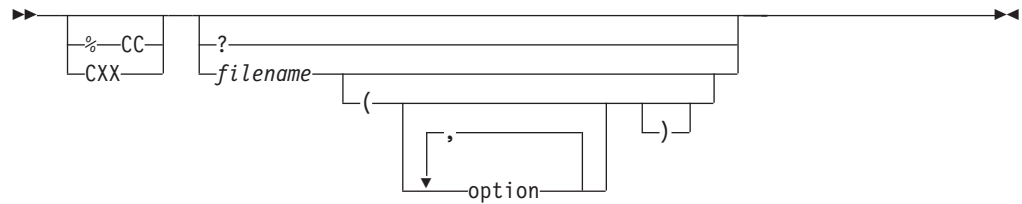

where

**%** ensures that the REXX EXEC CC is invoked

**option** is any valid compiler option

**filename** can be one of the following:

- A sequential data set
- A member of a partitioned data set
- All members of a partitioned data set
- A z/OS UNIX System Services file
- All files in a z/OS UNIX directory

If *filename* is not immediately recognizable as a z/OS UNIX file or data set, it is assumed to be a data set. Prefix the file name with // to identify it as a data set, and with ./ or / to identify it as a z/OS UNIX file. For more information on file naming considerations refer to *z/OS XL C/C++ Programming Guide*.

If you invoke either CC or CXX with no arguments or with only a single question mark, the appropriate preceding syntax diagram is displayed.

If you are using **#pragma options** to specify a compile-time option that generates an output file, you must use a ddname to specify the output file name. The compiler will not automatically generate file names for output that is created by **#pragma options**.

Unless CCNCCUST has been customized, the default SYSLIB for CC is CEE.SCEEH.H, and CEE.SCEEH.SYS.H concatenated. If you want to override the default SYSLIB that is allocated by the CC exec, you must allocate the ddname SYSLIB before you invoke CC. If you did not allocate the ddname SYSLIB before you invoked CC EXEC, the CC EXEC allocates the default SYSLIB.

## Specifying sequential and partitioned data sets

To specify a sequential or partitioned data set for your source file use the following syntax:

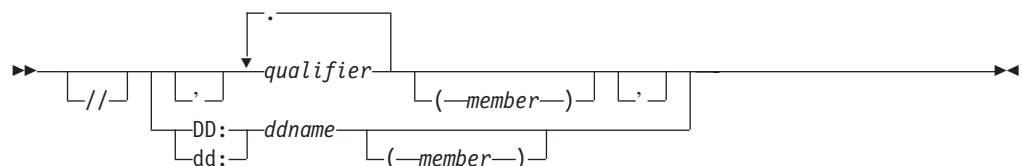

**Note:** If you use the leading single quote to indicating a fully qualified data set name, you must also use the trailing single quote.

## Specifying z/OS UNIX files or directories

You can use the CC or CXX REXX EXECs to compile source code that is stored in z/OS UNIX files and directories. Use the following syntax when specifying a z/OS UNIX file or directory as your input or output file:



If you specify a z/OS UNIX directory, all the source files in that directory are compiled. In the following example all the files in /u/david/src are compiled:

```
CC /u/david/src
```

When the file name contains the special characters double quote, blank or backslash, you must precede these characters with a backslash, as follows:

```
CC /u/david/db\ 1.c
CC file\"one
```

When you use the CC or CXX REXX EXEC, you must use unambiguous z/OS UNIX source file names. For example, the following input files are z/OS UNIX files:

```
CXX ./test/hello.c
CC /u/david/test/hello.c
CXX test/hello.c
CC ///hello.c
CC ../test/hello.c
```

If you specify a file name that does not include pathnames with single slashes, the compiler treats the file as a non-z/OS UNIX file. The compiler treats the following input files as non-z/OS UNIX files:

```
CXX hello.c
CC //hello.c
```

### Using special characters

When z/OS UNIX file names contain the special characters blank, backslash, and double quote, you must precede the special character with a backslash(\).

When suboptions contain the special characters left bracket (, right bracket ), comma, backslash, blank and double quote, you must precede these characters with a double backslash(\\) to ensure that they are interpreted correctly, as in:

```
def(errno=\\(*_errno\\(\\)\\))
```

**Note:** Under TSO, you must precede special characters by a backslash \ in both file names and options.

### Specifying compiler options under TSO

When you use REXX EXECs supplied by IBM, you can override the default compiler options by specifying the options directly on the invocation line after an open left parenthesis (.

**Example:** The following example specifies, multiple compiler options with the sequential file STUDENT.GRADES.CXX:

```

CXX 'STUDENT.GRADES.CXX'
  ( LIST,TEST,
    LSEARCH(MASTER.STUDENT,COURSE.TEACHER),
    SEARCH(VGM9.FINANCE,SYSABC.REPORTS),
    OBJ('GRADUATE.GRADES.OBJ(REPORT)')
  )

```

See “Summary of compiler options” on page 53 for more information on compiler options.

---

## Compiling and binding in the z/OS UNIX System Services environment

z/OS UNIX System Services C/C++ programs with source code in z/OS UNIX files or data sets must be compiled to create output object files residing either in z/OS UNIX files or data sets.

Both the SCEERUN and the SCEERUN2 libraries must be available when compiling in the z/OS UNIX System Services environment.

You can compile and bind application source code at one time, or compile the source and then bind at another time with other application source files or compiled objects.

As of z/OS V1R6, there are two utilities that enable you to invoke the compiler. The c89 utility enables compiler invocation using host environment variables and the xlc utility uses an external configuration file to control the invocation of the compiler. The following list highlights the differences between the xlc and c89 utilities:

- xlc utility uses the c89 utility to invoke the binder and the assembler and it has no direct interface to them
- xlc does not require that **lp64** and **xplink** be explicitly specified as options on the command line for both the compile and the bind step; it uses the **\_64** and **\_x** command name suffixes to ensure 64-bit and XPLINK compiles and binds
- xlc utility supports **-q** options syntax as the primary method of specifying options on the command line
- xlc utility is unaffected by the value assigned to the STEPLIB environment variable in the z/OS UNIX Systems Services session; it obtains the STEPLIB from the configuration file
- xlc utility supports the same command names as the c89 utility (**cc**, **c89**, **c++**, and **cxx**), so the PATH environment variable must contain the path to the **xlc** bin directory ahead of the **/bin** directory if the **xlc** version of **cc**, **c89**, **c++**, and **cxx** is desired
- xlc utility does not support **-WI** for invoking IPA; it uses **-O4** and **-O5** or **-qipa** as the mechanism for invoking IPA

**Note:** For more information on the xlc utility, see Chapter 21, “xlc — Compiler invocation using a customizable configuration file,” on page 527.

The c89 utility and xlc utility invoke the binder by default, unless the output file of the link-editing phase (**-o** option) is a PDS, in which case the prelinker is used.

For information on customizing your environment to compile and bind in the z/OS UNIX System Services environment, see “Environment variables” on page 504 or “Setting up a configuration file” on page 531.

Use the c89 utility or the xlc utility to compile and bind a C application program from the z/OS shell. The syntax is:

```
c89 [-options ...] [file.c ...] [file.a ...] [file.o ...] [-l libname]
```

where:

*options* are **c89** or **xlc** options.

*file.c* is a source file. Note that C source files have a file extension of lowercase c.

*file.o* is an object file.

*file.a* is an archive file.

*libname* is an archive library.

The **c89** and **xlc** utilities support IPA. For information on how to invoke the IPA Compile step using **c89** or **xlc**, refer to “Invoking IPA using the **c89** or **xlc** utilities” on page 310.

You can also use the **cc** command to compile a C application program from the z/OS shell. For more information, see Chapter 20, “**c89** — Compiler invocation using host environment variables,” on page 489 or the **xlc** command names described in Chapter 21, “**xlc** — Compiler invocation using a customizable configuration file,” on page 527.

Use the **c++** command to compile and bind a C++ application program from the z/OS shell. The syntax for **c++** is:

```
c++ [-options ...] [file.C ...] [file.a ...] [file.o ...] [-l libname]
```

where:

*options* are C++ options.

*file.C* is a source file. Note that C++ files have a file extension of uppercase C. The `_CXX_CXXSUFFIX` environment variable or `cxxsuffix` configuration file attribute can also be used to control which extensions are recognized as C++ file source extensions.

*file.o* is an object file.

*file.a* is an archive file.

*libname* is an archive library.

Another name for the **c++** command is **cxx**. The **cxx** command and the **c++** command are identical. You can use **cxx** instead of **c++** in all the examples that are shown in this section. If you are using the **xlc** utility, you can also use the **xlc** and the **xlc++** commands, which are identical to **c++** and **cxx**.

For a complete list of **c++** options, and for more information on **cxx**, see Chapter 20, “**c89** — Compiler invocation using host environment variables,” on page 489 and Chapter 21, “**xlc** — Compiler invocation using a customizable configuration file,” on page 527.

**Note:** You can compile and bind application program source and objects from within the shell using the **c89** or **xlc** utilities. If you use one of these utilities, you must keep track of and maintain all the source and object files for the application program. You can use the **make** utility to maintain your z/OS UNIX System Services application source files and object files automatically when you update individual modules. The **make** utility will only compile files that have changed since the last **make** run.

For more information on using the make utility, see Chapter 17, “Archive and make utilities,” on page 479 and *z/OS UNIX System Services Programming Tools*.

## Compiling without binding using compiler invocation command names supported by c89 and xlc

To compile source files without binding them, enter one of the supported command names (for example, **c89** or **c++**) with the **-c** option to create object file output. Use the **-o** option to specify placement of the application program executable file to be generated. The placement of the intermediate object file output depends on the location of the source file:

- If the z/OS XL C/C++ source module is a z/OS UNIX System Services file, the object file is created in the working directory.
- If the z/OS XL C/C++ source module is a data set, the object file is created as a data set. The object file is placed in a data set with the qualified name of the source and identified as an object.

For example, if the z/OS XL C/C++ source is in the sequential data set LANE.APPROG.USERSRC.C, the object is placed in the data set LANE.APPROG.USERSRC.OBJ. If the source is in the partitioned data set (PDS) member OLSEN.IPROGS.C(FILSER), the object is placed in the PDS member OLSEN.IPROGS.OBJ(FILSER).

**Note:** When the z/OS XL C/C++ source is located in a PDS member, you should specify double-quote characters around the qualified data set name. For example:

```
c89 -c "'/'OLSEN.IPROGS.C(FILSER)'"
```

If the file name is not bracketed by quotes, the parentheses around the member name in the fully qualified PDS name would be subject to special shell parsing rules.

Since the data set name is always converted to uppercase, you can specify it in lowercase or mixed case.

### Compiling z/OS XL C application source to produce only object files

c89 and xlc recognize that a file is a C source file by the **.c** suffix for z/OS UNIX System Services files, and the **.C** low-level qualifier for data sets. They recognize that a file is an object file by the **.o** suffix for z/OS UNIX files, and the **.OBJ** low-level qualifier for data sets.

To compile z/OS XL C source to create the default 32-bit object file `usersource.o` in your working z/OS UNIX directory, specify:

```
c89 -c usersource.c
```

To compile z/OS XL C source to create the default 64-bit object file `usersource.o` in your working z/OS UNIX directory, specify the following using the c89 utility:

```
c89 -c -Wc,lp64 usersource.c
```

The following shows the same example using the xlc utility:

```
c89_64 -c usersource.c
```

To compile z/OS XL C source to create an object file as a member in the PDS KENT.APPROG.OBJ, specify:

```
c89 -c "'/'kent.approg.c(usersrc)'"
```

## Compiling z/OS XL C++ application source to produce only object files

c89 and xlc recognize that a file is a C++ source file by the .C suffix for z/OS UNIX System Services files, and the .CXX low-level qualifier for data sets. They recognize that a file is an object file by the .o suffix for z/OS UNIX files, and the .OBJ low-level qualifier for data sets.

To compile z/OS XL C++ source to create the default 32-bit object file usersource.o in your working z/OS UNIX directory, specify the following:

```
c++ -c usersource.C
```

To compile z/OS XL C++ source to create the default 64-bit object file usersource.o in your working z/OS UNIX directory, using the c89 utility specify:

```
c++ -c -Wc,lp64 usersource.C
```

The following shows the same example using the xlc utility:

```
c++_64 usersource.C
```

To compile z/OS XL C++ source to create an object file as a member in the PDS JONATHAN.APPROG.OBJ, specify:

```
c++ -c "'/jonathan.approg.CXX(usersrc)'"
```

### Note:

To use the TSO utility OGET to copy a C++ z/OS UNIX listing file to a VBA data set, you must add a blank to any null records in the listing file. Use the **awk** command as follows if you are using the c89 utility:

```
c++ -cV mypgm.C | awk '/^[^$]/ {print} /^[^$]/  
{printf "%s \n", $0}' > mypgm.lst
```

The following shows the same example using the xlc utility:

```
x1C -c -qsource mypgm.C | awk '/^[^$]/ {print} /^[^$]/  
{printf "%s \n", $0}' > mypgm.lst
```

## Compiling and binding application source to produce an application executable file

To compile an application source file to create the 32-bit object file usersource.o in the z/OS UNIX System Services working directory and the executable file mymod.out in the /app/bin directory, specify:

```
c89 -o /app/bin/mymod.out usersource.c
```

To compile an application source file, to create the 64-bit object file usersource.o in the z/OS UNIX working directory and the executable file mymod.out in the /app/bin directory, specify the following using the c89 utility

```
c89 -Wc,lp64 -Wl,lp64 -o /app/bin/mymod.out usersource.c
```

The following shows the same example using the xlc utility:

```
c89_64 -o /app/bin/mymod.out usersource.c
```

To compile the z/OS XL C source member MAINBAL in the PDS CLAUDIO.PGMS.C, and bind it to produce the application executable file /u/claudio/myappls/bin/mainbal.out, specify:

```
c89 -o /u/claudio/myappls/bin/mainbal.out "'/claudio.pgms.C(MAINBAL)'"
```



## Compiling and binding in one step using compiler invocation command names supported by c89 and xlc

To compile and bind a XL C/C++ application program in one step to produce an executable file, specify **c89** or **c++** *without* specifying the **-c** option. You can use the **-o** option with the command to specify the name and location of the application program executable file that will be created. The **c++** and **cxx** commands are identical. You can use **cxx** instead of **c++** in all the examples that are shown in this section. If you are using the xlc utility, you can also use the **xlc** and **xlc++** commands, which are identical to **c++** and **cxx**.

The c89 utility and xlc utility invoke the binder by default, unless the output file of the link-editing phase (**-o** option) is a PDS, in which case the prelinker is used.

- To compile and bind an application source file to create the 32-bit default executable file a.out in the z/OS UNIX System Services working directory, specify:

```
c89 usersource.c
c++ usersource.C
```

- To compile and bind an application source file to create the 64-bit default executable file a.out in the z/OS UNIX working directory, specify:

```
c89 -Wc,lp64 -Wl,lp64 usersource.c
c++ -Wc,lp64 -Wl,lp64 usersource.C
xlc_64 usersource.C
```

- To compile and bind an application source file to create the mymod.out executable file in your /app/bin directory, specify:

```
c89 -o /app/bin/mymod.out usersource.c
c++ -o /app/bin/mymod.out usersource.C
```

- To compile and bind several application source files to create the mymod.out executable file in your /app/bin directory, specify:

```
c89 -o /app/bin/mymod.out usrsrc.c otsrc.c "'/MUSR.C(PWAPP)'"
c++ -o /app/bin/mymod.out usrsrc.C otsrc.C "'/MUSR.C(PWAPP)'"
```

- To compile and bind an application source file to create the MYLOADMD member of your APPROG.LIB PDS, specify:

```
c89 -o "'/APPROG.LIB(MYLOADMD)'" usersource.c
c++ -o "'/APPROG.LIB(MYLOADMD)'" usersource.C
```

- To compile and bind an application source file with several previously compiled object files to create the executable file zinfo in your /prg/lib z/OS UNIX directory, specify:

```
c89 -o /prg/lib/zinfo usrsrc.c xstobj.o "'/MUSR.OBJ(PWAPP)'"
c++ -o /prg/lib/zinfo usrsrc.C xstobj.o "'/MUSR.OBJ(PWAPP)'"
```

- To compile and bind an application source file and capture the listings from the compile and bind steps into another file, specify:

```
c89 -V barry1.c > barry1.lst
c++ -V barry1.C > barry1.lst
```

**Note:** -V does not cause all listings to be emitted when you invoke the compiler using xlc. Use, for example, **-qsource** or **-qlist** instead.

## Building an application with XPLINK using the c89 or xlc utilities

To build an application with XPLINK using the c89 utility you must specify the XPLINK compiler option (i.e., **-Wc,xplink**) and the XPLINK binder option (i.e., **-WI,xplink**). The binder option is not actually passed to the binder. It is used by c89 to set up the appropriate link data sets.

To build an application with XPLINK using the xlc utility, you do not have to explicitly specify the **xplink** option on the command line for either the compile or the bind step. xlc uses the **\_x** command name suffix to ensure XPLINK compiles and binds.

## Building a 64-bit application using the c89 or xlc utilities

To build a 64-bit application using the c89 utility, you must use the LP64 compiler option (i.e., **-Wc,lp64**) and the LP64 binder option (i.e., **-WI,lp64**). The binder option is not actually passed to the binder. It is used by c89 to set up the appropriate link data sets.

To build a 64-bit application using the **xlc** utility, you do not have to explicitly specify the **lp64** option on the command line for either the compile or the bind step. xlc uses the **\_64** command name suffix to ensure 64-bit compiles and binds.

## Invoking IPA using the c89 or xlc utilities

You can invoke the IPA Compile step, the IPA Link step, or both using the c89 or xlc utilities. The step that you invoke depends upon the invocation parameters and type of files specified. To invoke IPA using **c89**, you must specify the I phase indicator along with the W option of the **c89** utility. You can specify IPA suboptions as comma-separated keywords. To invoke IPA using **xlc**, you must use the **-qipa**, **-O4**, or **-O5** options. You can specify IPA suboptions as colon-separated keywords.

If you invoke the c89 utility or xlc utility by specifying the **-c** compiler option and at least one source file, **c89** or **xlc** automatically specifies IPA(NOLINK) and automatically invokes the IPA Compile step. For example, the following **c89** command invokes the IPA Compile step for the source file `hello.c`:

```
c89 -c -WI,noobject hello.c
```

The following **xlc** command invokes the IPA Compile step for the source file `hello.c`:

```
xlc -c -qipa=noobject hello.c
```

If you invoke c89 or xlc with at least one source file for compilation and any number of object files, and do not specify the **-c** option, c89 or xlc invokes the IPA Compile step once for each compilation unit. It then invokes the IPA Link step once for the entire program, and then invokes the binder.

**Example:** The following **c89** command invokes the IPA Compile step, the IPA Link step, and the bind step while creating program `foo`:

```
c89 -o foo -WI,object foo.c
```

The following shows the same example using the xlc utility:

```
xlc -o foo -qipa=object foo.c
```

Refer to Chapter 20, “c89 — Compiler invocation using host environment variables,” on page 489 for more information about the c89 utility or Chapter 21, “xlc — Compiler invocation using a customizable configuration file,” on page 527 for more information about the xlc utility.

### Specifying options for the IPA Compile step

You can pass options to the IPA Compile step, as follows:

- You can pass IPA compiler option suboptions by specifying **-WI**, for c89 or **-qipa=** for xlc, followed by the suboptions.
- You can pass compiler options by specifying **-Wc**, for c89 or **-q** for xlc, followed by the options.

## Using IPA(OBJONLY) with the c89 or xlc utilities

A compilation using IPA(OBJONLY) is simply a standard non-IPA compilation with this option added. Do not use the **-WI** flag with c89 or **-qipa** with xlc, as this would convert the compilation into an IPA Compile step.

**Example:** The following c89 command results in an OPT(2) IPA(OBJONLY) compilation for the source file hello.c:

```
c89 -c -Wc,ipa\objonly\ -2 hello.c
```

The following shows the same example using the xlc utility:

```
xlc -c -Wc,ipa\objonly\ -02 hello.c
```

## Using the make utility

You can use the make utility to control the build of your z/OS UNIX System Services XL C/C++ applications. The make utility calls the c89 utility by default to compile and bind the programs that the previously created makefile specifies.

**Example:** To create myappl you compile and bind two source parts mymain.c and mysub.c. This dependency is captured in makefile /u/jake/myappl/Makefile. No recipe is specified, so the default makefile rules are used. If myappl was built and a subsequent change was made only to mysub.c, you would specify:

```
cd /u/jake/myappl  
make
```

The make utility sees that mysub.c has changed, and invokes the following commands for you:

```
c89 -0 -c mysub.c  
c89 -o myappl mymain.o mysub.o
```

**Note:** The make utility requires that application program source files that are to be “maintained” through use of a makefile reside in z/OS UNIX files. To compile and bind z/OS XL C/C++ source files that are in data sets, you must use the c89 utility directly.

See *z/OS UNIX System Services Command Reference* for a description of the make utility. For a detailed discussion on how to create and use makefiles to manage application parts, see *z/OS UNIX System Services Programming Tools*.

---

## Compiling with IPA

If you request Interprocedural Analysis (IPA) through the IPA compiler option, the compilation process changes significantly. IPA instructs the compiler to optimize your z/OS XL C/C++ program across compilation units, and to perform optimizations that are not otherwise available with the z/OS XL C/C++ compiler. You should refer to *z/OS XL C/C++ Programming Guide* for an overview of IPA processing before you invoke the compiler with the IPA compiler option.

Differences between the IPA compilation process and the regular compilation process are noted throughout this chapter.

Figure 19 shows the flow of processing for a regular compilation:

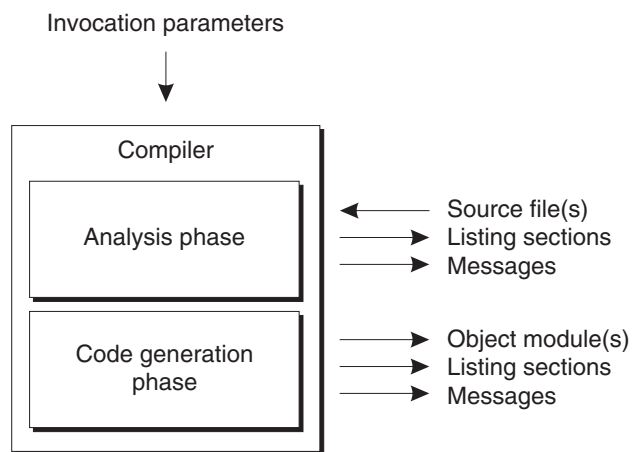

Figure 19. Flow of regular compiler processing

IPA processing consists of two separate steps, called the *IPA Compile step* and the *IPA Link step*.

### The IPA Compile step

The IPA Compile step is similar to a regular compilation.

You invoke the IPA Compile step for each source file in your application by specifying the IPA(NOLINK) compiler option or by specifying **-Wc,IPA** or **-WI -c** in z/OS UNIX System Services. The output of the IPA Compile step is an object file which contains IPA information, or both IPA information and conventional object code and data. The IPA information is an encoded form of the compilation unit with additional IPA-specific compile-time optimizations.

Figure 20 on page 313 shows the flow of IPA Compile step processing.

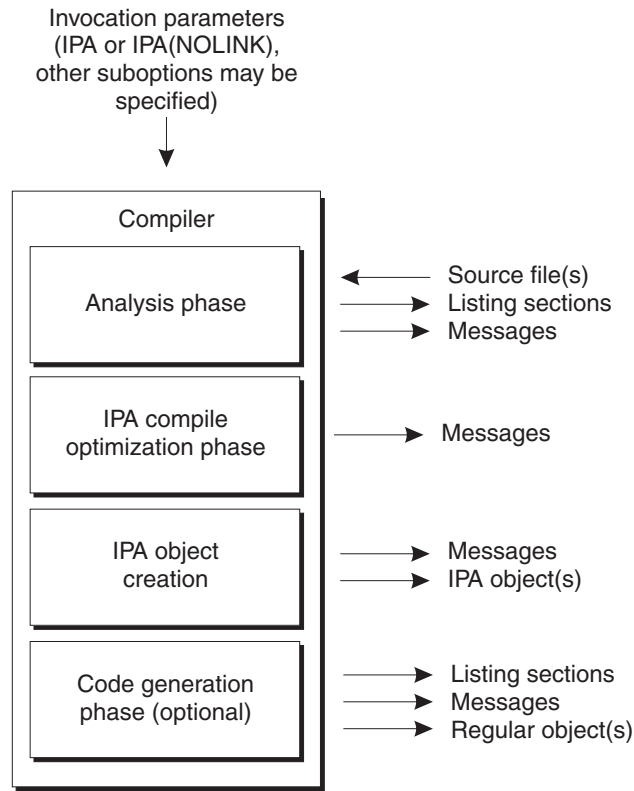

Figure 20. IPA Compile step processing

The same environments that support a regular compilation also support the IPA Compile step.

## The IPA Link step

The IPA Link step is similar to the binding process.

You invoke the IPA Link step by specifying the IPA(LINK) compiler option or by specifying **-WI** without specifying **-c** in z/OS UNIX System Services. This step links the user application program together by combining object files with IPA information, object files with conventional object code and data, and load module members. It merges IPA information, performs IPA Link-time optimizations, and generates the final object code and data.

Each application program module must be built with a single invocation of the IPA Link step. All parts must be available during the IPA Link step; missing parts may result in termination of IPA Link processing.

Figure 21 on page 314 shows the flow of IPA Link step processing:

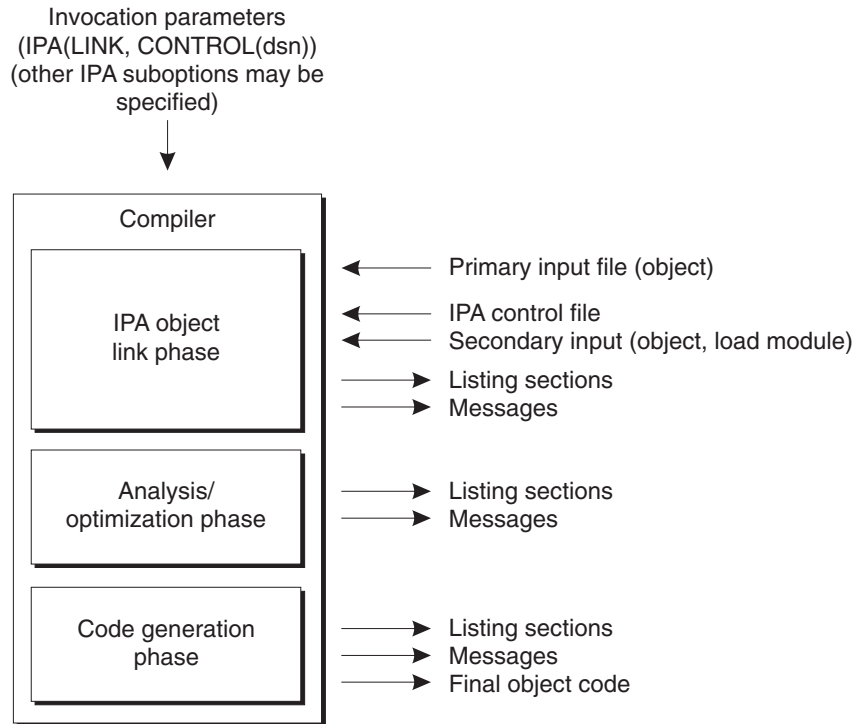

Figure 21. IPA Link step processing

Only c89, xlc, c++ and z/OS batch support the IPA Link step. Refer to Chapter 8, “Using the IPA Link step with z/OS XL C/C++ programs,” on page 329 for information about the IPA Link step.

## Compiling with IPA(OBJONLY)

The full Interprocedural Analysis using the IPA Compile and IPA Link steps performs significant optimizations beyond those which are available using regular compilation. If problems occur, diagnosis may take significant time and effort.

The IPA(OBJONLY) compilation is an intermediate level of optimization. This results in a modified regular compile, not an IPA Compile step. Unlike the IPA Compile step, no IPA information is written to the object file.

During compilation, this step performs the same IPA-specific compile-time optimizations as the IPA Compile step, performs the requested non-IPA optimizations, and then generates optimized object code and data.

You invoke the compiler for each source file in your application by specifying the IPA(OBJONLY) compiler option.

The object file may be used by an IPA Link step, a prelink/link, or a bind. If it is used as input to an IPA Link step, no IPA Link-time optimizations can be performed for this compilation unit because no IPA information is available.

Figure 22 on page 315 shows the flow of processing for an IPA(OBJONLY) compilation.

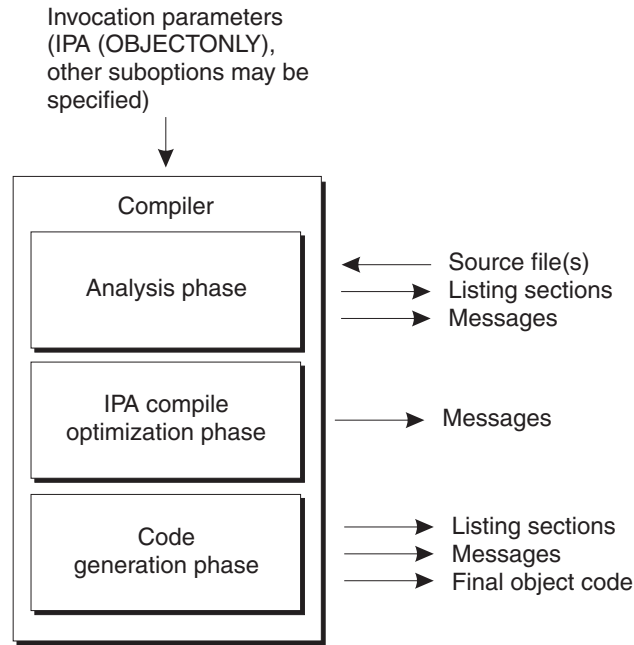

Figure 22. Compiling with IPA(OBJECTONLY)

## Working with object files

z/OS object files are composed of a stream of 80 byte records. These may be binary object records, or link control statements. It is useful to be able to browse the contents of an object file, so that some basic information can be determined.

### Browsing object files

Object files, which are sequential data sets or are members of a PDS or PDSE object library, can be browsed directly using the Program Development Facility (PDF) edit and browse options.

Object files, which are z/OS UNIX System Services files, can be browsed using the PDF **obrowse** command. z/OS UNIX files can be browsed using the TSO ISHELL command, and then using the V (View) action (V on the Command line, or equivalently **Browse records** from the File pull-down menu). This will result in a pop-up window for entering a record length. To force display in F 80 record mode, one would issue the following sequence of operations:

1. Enter the command: **obrowse file.o**

Note that the file name is deliberately typed with an extra character. This will result in the display of an obrowse dialog panel with an error message that the file is not found. After pressing Enter, a second obrowse dialog is displayed to allow the file name to be corrected. This panel has an entry field for the record length.

2. Correct the file name and enter 80 in the record length entry field.
3. Browse the object records as you would a F 80 data set.

The hex display mode (enabled by the HEX ON primary command) allows the value of each byte to be displayed.





## Specifying include file names

You can use the SEARCH and LSEARCH compiler options to specify search paths for system include files and user include files. For more information on these options, see “LSEARCH | NOSEARCH” on page 153 and “SEARCH | NOSEARCH” on page 183.

You can specify *filename* of the #include directive in the following format:

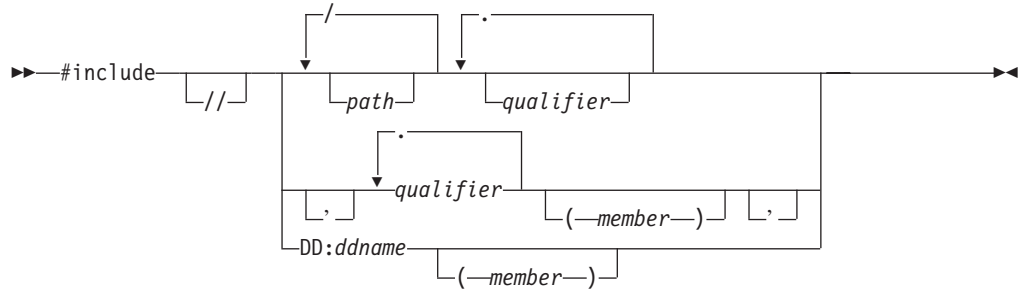

The leading double slashes (//) not followed by a slash (in the first character of *filename*) indicate that the file is to be treated as a non-z/OS UNIX System Services file, hereafter called a data set.

### Note:

1. *filename* immediately follows the double slashes (//) without spaces.
2. Absolute data set names are specified by putting single quotation marks (') around the name. Refer to the above syntax diagram for this specification.
3. Absolute z/OS UNIX file names are specified by putting a leading slash (/) as the first character in the file name.
4. ddnames are always considered absolute.

## Forming file names

Refer to “Determining whether the file name is in absolute form” on page 321 for information on absolute file names. When the compiler performs a library search, it treats *filename* as either a z/OS UNIX System Services file name or a data set name. This depends on whether the library being searched is a z/OS UNIX library or MVS library. If the compiler treats *filename* as a z/OS UNIX file name, it does not perform any conversions on it. If it treats *filename* as a data set name (DSN), it performs the following conversion:

- For the first DSN format:



The compiler:

1. Uppercases *qualifier* and *path*
  2. Truncates each *qualifier* and *path* to 8 characters
  3. Converts the underscore character (which is invalid for a DSN) to the '@' character (hex 7c)
- For the second DSN format:

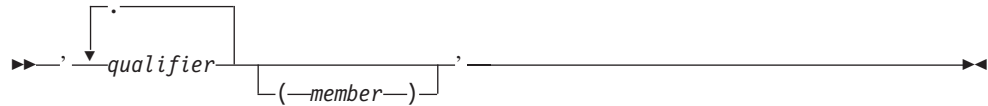

The compiler:

1. Uppercases the *qualifier* and *member*
  2. Converts the underscore character (which is invalid for a DSN) to the '@' character (hex 7c)
- For the third DSN format:

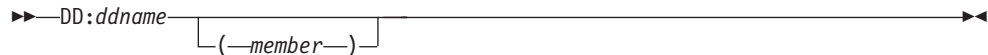

The compiler:

1. Uppercases the `DD:`, *ddname*, and *member*
2. Converts the underscore character (which is invalid for a DSN) to the '@' character (hex 7c)

## Forming data set names with LSEARCH | SEARCH options

When the *filename* specified in the `#include` directive is not in absolute form, the compiler combines it with different types of libraries to form complete data set specifications. These libraries may be specified by the LSEARCH or SEARCH compiler options. When the LSEARCH or SEARCH option indicates a data set then, depending on whether it is a ddname, sequential data set, or PDS, different parts of *filename* are used to form the ddname or data set name.

### Forming DDname

**Example:** The leftmost qualifier of the *filename* in the `#include` directive is used when the *filename* is to be a ddname:

**Invocation:**

```
SEARCH(DD:SYSLIB)
```

**Include directive:**

```
#include "sys/afile.g.h"
```

**Resulting ddname:**

```
DD:SYSLIB(AFILE)
```

In the above example, if your header file includes an underscore (`_`), for example, `#include "sys/afile_1.g.h"`, the resulting ddname is `DD:SYSLIB(AFILE@1)`.

### Forming sequential data set names

**Example:** You specify libraries in the SEARCH | LSEARCH options as sequential data sets by using a trailing period followed by an asterisk (`.*`), or by a single asterisk (`*`). See “Specifying sequential data sets and PDSs” on page 156 to understand how to specify sequential data sets. All *qualifiers* and periods (`.`) in *filename* are used for sequential data set specification.

**Invocation:**

```
SEARCH(AA.*)
```

**Include directive:**

```
#include "sys/afile.g.h"
```

**Resulting fully qualified data set name:**

```
userid.AA.AFIL.E.G.H
```

## Forming PDS name with LSEARCH | SEARCH + specification

**Example:** To specify libraries in the SEARCH and LSEARCH options as PDSs, use a period that is followed by a plus sign (.+), or a single plus sign (+). See “Specifying sequential data sets and PDSs” on page 156 to understand how PDSs are specified. When this is the case then all the *paths*, slashes (replaced by periods), and any *qualifiers* following the leftmost *qualifier* of the *filename* are appended to form the data set name. The leftmost *qualifier* is then used as the member name.

### Invocation:

```
SEARCH('AA.+')
```

### Include directive:

```
#include "sys/afile.g.h"
```

### Resulting fully qualified data set name:

```
AA.SYS.G.H(AFILE)
```

and

### Invocation:

```
SEARCH('AA.+')
```

### Include directive:

```
#include "sys/bfile"
```

### Resulting fully qualified data set name:

```
AA.SYS(BFILE)
```

## Forming PDS with LSEARCH | SEARCH Options with No +

**Example:** When the LSEARCH or SEARCH option specifies a library but it neither ends with an asterisk (\*) nor a plus sign (+), it is treated as a PDS. The leftmost qualifier of the *filename* in the `#include` directive is used as the member name.

### Invocation:

```
SEARCH('AA')
```

### Include directive:

```
#include "sys/afile.g.h"
```

### Resulting fully qualified data set name:

```
AA(AFILE)
```

## Examples of forming data set names

The following table gives the original format of the *filename* and the resulting converted name when you specify the NOOE option:

Table 34. Include filename conversions when NOOE is specified

| #include Directive  | Converted Name      |
|---|---------------------|
| Example 1. This <i>filename</i> is absolute because single quotation marks (') are used. It is a sequential data set. A library search is not performed. LSEARCH is ignored.  |                     |
| #include "'USER1.SRC.MYINCS'"   | USER1.SRC.MYINCS    |
| Example 2. This <i>filename</i> is absolute because single quotation marks (') are used. The compiler attempts to open data set COMIC/BOOK.OLDIES.K and fails because it is not a valid data set name. A library search is not performed when <i>filename</i> is in absolute form. SEARCH is ignored. |                     |
| #include <'COMIC/BOOK.OLDIES.K'>  | COMIC/BOOK.OLDIES.K |
| Example 3.  |                     |

Table 34. Include filename conversions when NOOE is specified (continued)

| #include Directive   | Converted Name  |
|--|---|
| SEARCH(LIB1.*,LIB2.+,LIB3) #include "sys/abc/xx"   | <ul style="list-style-type: none"> <li>• first <i>opt</i> in SEARCH SEQUENTIAL FILE = <i>userid</i>.LIB1.XX</li> <li>• second <i>opt</i> in SEARCH PDS = <i>userid</i>.LIB2.SYS.ABC(XX)</li> <li>• third <i>opt</i> in SEARCH PDS = <i>userid</i>.LIB3(XX)</li> </ul>                   |
| Example 4.   |   |
| SEARCH(LIB1.*,LIB2.+,LIB3) #include "Sys/ABC/xx.x"   | <ul style="list-style-type: none"> <li>• first <i>opt</i> in SEARCH SEQUENTIAL FILE = <i>userid</i>.LIB1.XX.X</li> <li>• second <i>opt</i> in SEARCH PDS = <i>userid</i>.LIB2.SYS.ABC.X(XX)</li> <li>• third <i>opt</i> in SEARCH PDS = <i>userid</i>.LIB3(XX)</li> </ul>               |
| Example 5.   |   |
| SEARCH(LIB1.*,LIB2.+,LIB3) #include <sys/name_1>   | <ul style="list-style-type: none"> <li>• first <i>opt</i> in SEARCH SEQUENTIAL FILE = <i>userid</i>.LIB1.NAME@1</li> <li>• second <i>opt</i> in SEARCH PDS = <i>userid</i>.LIB2.SYS(NAME@1)</li> <li>• third <i>opt</i> in SEARCH PDS = <i>userid</i>.LIB3(NAME@1)</li> </ul>           |
| Example 6.   |   |
| SEARCH(LIB1.*,LIB2.+,LIB3) #include <Name2/App1.App2.H>  | <ul style="list-style-type: none"> <li>• first <i>opt</i> in SEARCH SEQUENTIAL FILE = <i>userid</i>.LIB1.APP1.APP2.H</li> <li>• second <i>opt</i> in SEARCH PDS = <i>userid</i>.LIB2.NAME2.APP2.H(APP1)</li> <li>• third <i>opt</i> in SEARCH PDS = <i>userid</i>.LIB3(APP1)</li> </ul> |
| Example 7. The PDS member named YEAREND of the library associated with the ddname PLANLIB is used. A library search is not performed when <i>filename</i> in the #include directive is in absolute form (ddname is used). SEARCH is ignored. |   |
| #include <dd:planlib(YEAREND)>   | DD:PLANLIB(YEAREND)   |

## Search sequence

The following diagram describes the compiler file searching sequence:

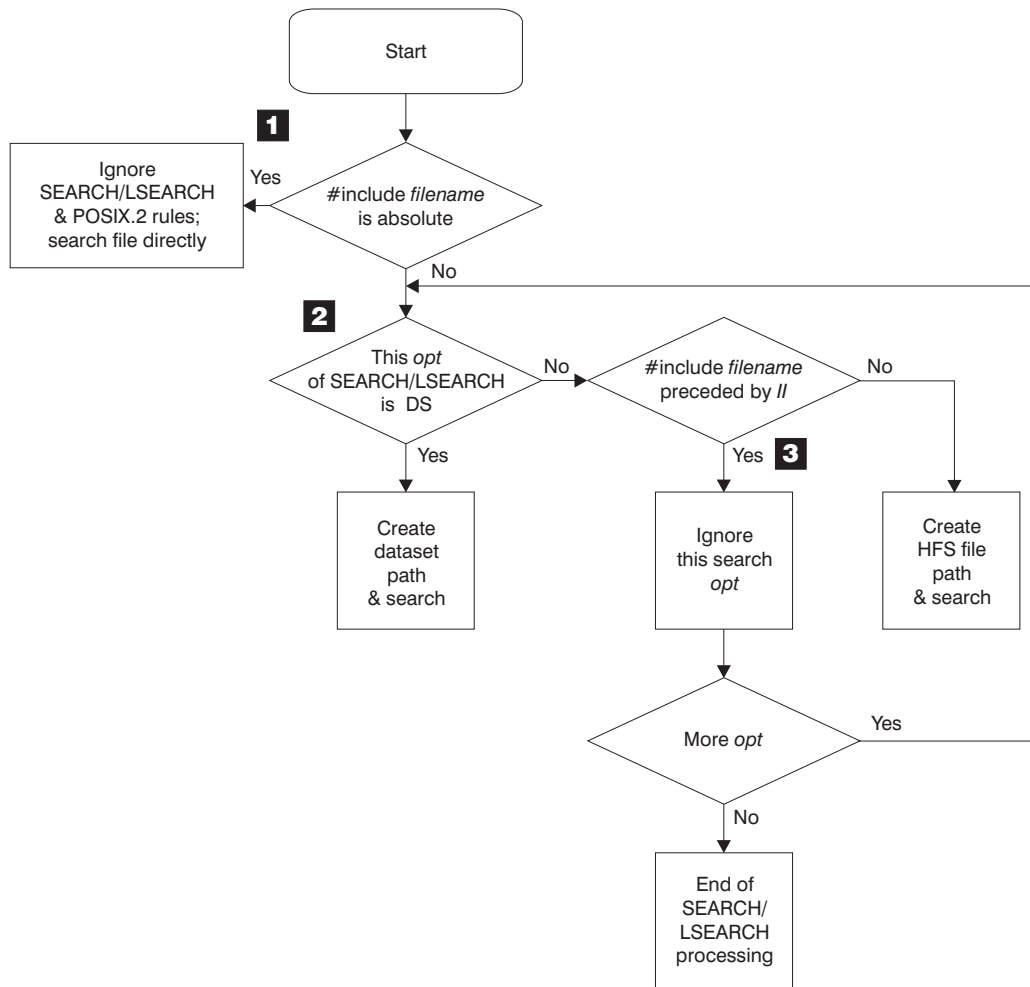

Figure 23. Overview of include file searching

- 1** The compiler opens the file without library search when the file name that is specified in `#include` is in absolute form. This also means that it bypasses the rules for the `SEARCH` and `LSEARCH` compiler options, and for `POSIX.2`. See Figure 24 on page 322 for more information on absolute file testing.
- 2** When the file name is not in absolute form, the compiler evaluates each option in `SEARCH` and `LSEARCH` to determine whether to treat the file as a data set or a z/OS UNIX System Services file search. The `LSEARCH/SEARCH` *opt* testing here is described in Figure 25 on page 324.
- 3** When the `#include` file name is not absolute, and is preceded by exactly two slashes (`//`), the compiler treats the file as a data set. It then bypasses all z/OS UNIX file options of the `SEARCH` and `LSEARCH` options in the search.

## Determining whether the file name is in absolute form

The compiler determines if the file name that is specified in `#include` is in absolute form as follows:

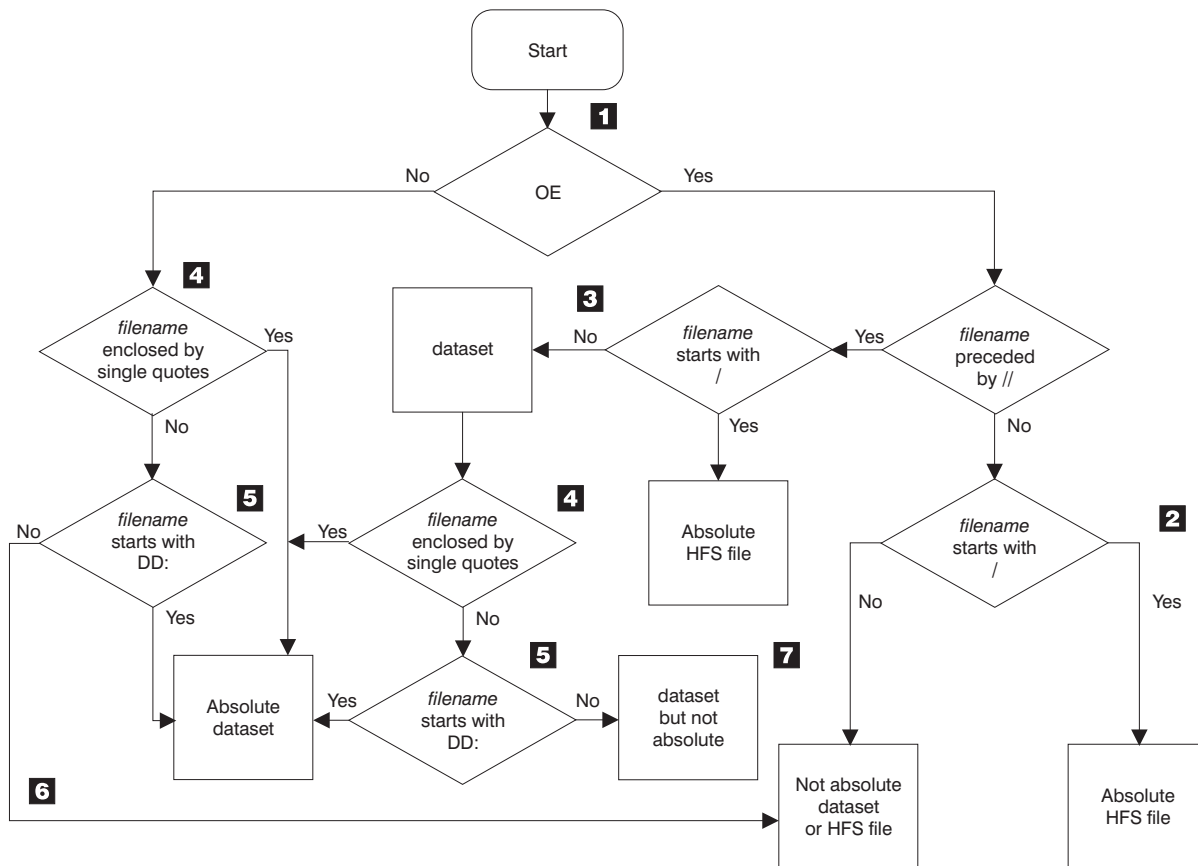

Figure 24. Testing if filename is in absolute form

- 1** The compiler first checks whether you specified OE.
- 2** When you specify OE, if double slashes (//) do not precede *filename*, and the file name starts with a slash (/), then *filename* is in absolute form and the compiler opens the file directly as a z/OS UNIX file. Otherwise, the file is not an absolute file and each *opt* in the SEARCH or LSEARCH compiler option determines if the file is treated as a z/OS UNIX file or data set in the search for the include file.
- 3** When OE is specified, if double slashes (//) precede *filename*, and the file name starts with a slash (/), then *filename* is in absolute form and the compiler opens the file directly as a z/OS UNIX file. Otherwise, the file is a data set, and more testing is done to see if the file is absolute.
- 4** If *filename* is enclosed in single quotation marks ('), then it is an absolute data set. The compiler directly opens the file and ignores the libraries that are specified in the LSEARCH or SEARCH options. If there are any invalid characters in *filename*, the compiler converts the invalid characters to at signs (@, hex 7c).
- 5** If you used the ddname format of the #include directive, the compiler uses the file associated with the ddname and directly opens the file as a data set. The libraries that are specified in the LSEARCH or SEARCH options are ignored.
- 6** If none of the above conditions are true then *filename* is not in absolute

format and each *opt* in the SEARCH or LSEARCH compiler option determines if the file is a z/OS UNIX file or a data set and then searches for the include file.

- 7** If none of the above conditions are true, then *filename* is a data set, but it is not in absolute form. Only *opts* in the SEARCH or LSEARCH compiler option that are in data set format are used in the search for include file.

For example:

Options specified:

OE

Include Directive:

|                              |  |
|------------------------------|--|
| #include "apath/afile.h"     | NOT absolute, z/OS UNIX file/<br>MVS (no starting slash) |
| #include "/apath/afile.h"    | absolute z/OS UNIX file,<br>(starts with 1 slash)        |
| #include "//apath/afile.h.c" | NOT absolute, MVS (starts with 2 slashes)                |
| #include "a.b.c"             | NOT absolute, z/OS UNIX file/<br>MVS (no starting slash) |
| #include "///apath/afile.h"  | absolute z/OS UNIX file,<br>(starts with 3 slashes)      |
| #include "DD:SYSLIB"         | NOT absolute, z/OS UNIX file/<br>MVS (no starting slash) |
| #include "//DD:SYSLIB"       | absolute, MVS (DD name)                                  |
| #include "a.b(c)"            | NOT absolute, z/OS UNIX file/<br>MVS (no starting slash) |
| #include "//a.b(c)"          | NOT absolute, OS/MVS (PDS member name)                   |

## Using SEARCH and LSEARCH

When the file name in the #include directive is not in absolute form, the *opts* in SEARCH are used to find system include files and the *opts* in LSEARCH are used to find user include files. Each *opt* is a library path and its format determines if it is a z/OS UNIX System Services path or a data set path:

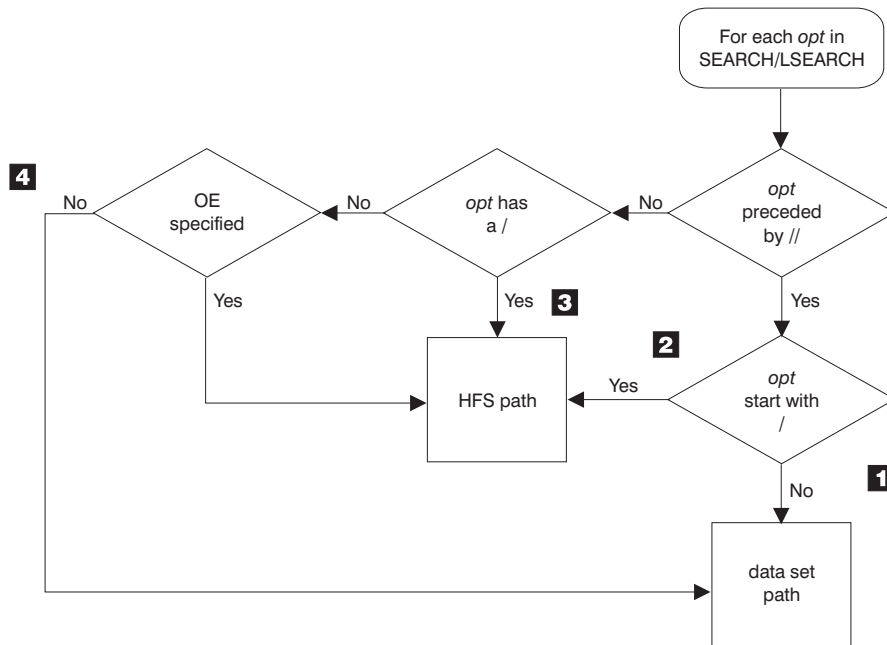

Figure 25. Determining if the SEARCH/LSEARCH opt is a z/OS UNIX path

**Note:**

1. If *opt* is preceded by double slashes (//) and *opt* does not start with a slash (/), then this path is a data set path.
2. If *opt* is preceded by double slashes (//) and *opt* starts with a slash (/), then this path is a z/OS UNIX path.
3. If *opt* is **not** preceded by double slashes (//) and *opt* starts with a slash (/), then this path is a z/OS UNIX path.
4. If *opt* is **not** preceded by double slashes (//), *opt* does not start with a slash (/) and NOOE is specified then this path is a data set path.

For example:

|                     |                                    |
|---------------------|------------------------------------|
| SEARCH(./PATH)      | is an explicit z/OS UNIX path      |
| OE SEARCH(PATH)     | is treated as az/OS UNIX path      |
| NOOE SEARCH(PATH)   | is treated as a non-z/OS UNIX path |
| NOOE SEARCH(//PATH) | is an explicit non-z/OS UNIX path  |

**Example:** When combining the library with the file name specified on the #include directive, it is the form of the library that determines how the include file name is to be transformed:

Options specified:

```
NOOE LSEARCH(Z, /u/myincs, (*.h)=(LIB(mac1)))
```

Include Directive:

```
#include "apath/afile.h"
```

Resulting fully qualified include names:

1. *userid.Z(AFILE)* (Z is non-z/OS UNIX file so file name is treated as non-z/OS UNIX file)



```

| 2. /u/myincs/apath/afile.h (/u/myincs is z/OS UNIX file so
| file name is treated as z/OS UNIX file)
| 3. userid.MAC1.H(AFIL) (afile.h matches *.h)

```

**Example:** A z/OS UNIX path specified on a SEARCH or LSEARCH option only combines with the file name specified on an #include directive if the file name is not explicitly stated as being MVS only. A file name is explicitly stated as being MVS only if two slashes (//) precede it, and *filename* does not start with a slash (/).

Options specified:

```
OE LSEARCH(/u/myincs, q, //w)
```

Include Directive:

```
#include "//file.h"
```

Resulting fully qualified include names

```
userid.W(FILE)
```

/u/myincs and q would not be combined with //file.h because both paths are z/OS UNIX paths and //file.h is explicitly MVS.

The order in which options on the LSEARCH or SEARCH option are specified is the order that is searched.

See “LSEARCH | NOLSEARCH” on page 153 and “SEARCH | NOSEARCH” on page 183 for more information on these compiler options.

---

## Search sequences for include files

The status of the OE option affects the search sequence.

### With the NOOE option

Search sequences for include files are used when the include file is not in absolute form. “Determining whether the file name is in absolute form” on page 321 describes the absolute form of include files.

If the include filename is not absolute, the compiler performs the library search as follows:

- For system include files:
  1. The search order as specified on the SEARCH option, if any
  2. The libraries specified on the SYSLIB DD statement
- For user include files:
  1. The directory of the file that contains the #include directive
  2. When the containing file is a z/OS UNIX file, the search order as specified on the LSEARCH option, if any
  3. The libraries specified on the USERLIB DD statement
  4. The search order for system include files

**Example:** The example below shows an excerpt from a JCL stream, that compiles a C program for a user whose user prefix is JONES:

```

//COMPILE EXEC PROC=EDCC,
//          CPARM='SEARCH(''BB.D'',BB.F),LSEARCH(CC.X)'
//SYSLIB DD DSN=JONES.ABC.A,DISP=SHR
//          DD DSN=ABC.B,DISP=SHR
//USERLIB DD DSN=JONES.XYZ.A,DISP=SHR
//          DD DSN=XYZ.B,DISP=SHR

```

```
//SYSIN DD DSN=JONES.ABC.C(D),DISP=SHR
.
.
.
```

The search sequence that results from the preceding JCL statements is:

Table 35. Order of search for include files

| Order of Search | For System Include Files | For User Include Files |
|-----------------|--------------------------|------------------------|
| First           | BB.D                     | JONES.CC.X             |
| Second          | JONES.BB.F               | JONES.XYZ.A            |
| Third           | JONES.ABC.A              | XYZ.B                  |
| Fourth          | ABC.B                    | BB.D                   |
| Fifth           |                          | JONES.BB.F             |
| Sixth           |                          | JONES.ABC.A            |
| Seventh         |                          | ABC.B                  |

## With the OE option

Search sequences for include files are used when the include file is not in absolute form. “Determining whether the file name is in absolute form” on page 321 describes the absolute form of an include file.

If the include filename is not absolute, the compiler performs the library search as follows:

- For system include files:
  1. The search order as specified on the SEARCH option, if any
  2. The libraries specified on the SYSLIB DD statement
- For user include files:
  1. If you specified OE with a file name and the file being processed is a z/OS UNIX System Services file and a main source file, the directory of the file containing the #include directive
  2. The search order as specified on the LSEARCH option, if any
  3. The libraries specified on the USERLIB DD statement
  4. The search order for system include files

**Example:** The following shows an example where you are given a file /r/you/cproc.c that contains the following #include directives:

```
#include "/u/usr/header1.h"
#include "//aa/bb/header2.x"
#include "common/header3.h"
#include <header4.h>
```

And the following options:

```
OE(/u/crossi/myincs/cproc)
SEARCH(/V.+ , /new/inc1, /new/inc2)
LSEARCH(/>(*.)=(lib(AAA)), /c/c1, /c/c2)
```

The include files would be searched as follows:

Table 36. Examples of search order for z/OS UNIX System Services

| #include Directive Filename   | Files in Search Order |
|---|-----------------------|
| Example 1. This is an absolute pathname, so no search is performed. |                       |

Table 36. Examples of search order for z/OS UNIX System Services (continued)

| #include Directive Filename  | Files in Search Order  |
|--|--|
| #include "/u/usr/header1.h"  | 1. /u/usr/header.h   |
| Example 2. This is a data set (starts with //) and is treated as such.   |  |
| "//aa/bb/header2.x"  | 1. <i>userid</i> .AAA(HEADER2)<br>2. DD:USERLIB(HEADER2)<br>3. <i>userid</i> .V.AA.BB.X(HEADER2)<br>4. DD:SYSLIB(HEADER2)  |
| Example 3. This is a system include file with a relative path name. The search starts with the directory of the parent file or the name specified on the OE option if the parent is the main source file (in this case the parent file is the main source file so the OE suboption is chosen i.e. /u/crossi/myincs). |  |
| "common/header3.h"   | 1. /u/crossi/myincs/common/header3.h<br>2. /c/c1/common/header3.h<br>3. /c/c2/common/header3.h<br>4. DD:USERLIB(HEADER3)<br>5. <i>userid</i> .V.COMMON.H(HEADER3)<br>6. /new/inc1/common/header3.h<br>7. /new/inc2/common/header3.h<br>8. DD:SYSLIB(HEADER3) |
| Example 4. This is a system include file with a relative path name. The search follows the order of suboptions of the SEARCH option.   |  |
| <header4.h>  | 1. <i>userid</i> .V.H(HEADER4)<br>2. /new/inc1/common/header4.h<br>3. /new/inc2/common/header4.h<br>4. DD:SYSLIB(HEADER4)  |

## Compiling z/OS XL C source code using the SEARCH option

The following data sets contain the commonly-used system header files for C:<sup>3</sup>

- CEE.SCEEH.H (standard header files)
- CEE.SCEEH.SYS.H (standard system header files)
- CEE.SCEEH.ARPA.H (standard internet operations headers)
- CEE.SCEEH.NET.H (standard network interface headers)
- CEE.SCEEH.NETINET.H (standard internet protocol headers)

To specify that the compiler search these data sets, code the option:

```
SEARCH('CEE.SCEEH.+')
```

These header files are also in the z/OS UNIX System Services directory /usr/include. To specify that the compiler search this directory, code the option:

```
SEARCH(/usr/include/)
```

This option is the default for the c89 utility.

IBM supplies this option as input to the Installation and Customization of the compiler. Your system programmer can modify it as required for your installation.

The cataloged procedures, REXX EXECs, and panels that are supplied by IBM for C specify the following data sets for the SYSLIB ddname by default:

- CEE.SCEEH.H (standard header files)

3. The high-level qualifier may be different for your installation.

- CEE.SCEEH.SYS.H (standard system header files)

This is supplied for compatibility with previous releases, and will be overridden if SEARCH() is used as described above.

## Compiling z/OS XL C++ source code using the SEARCH option

The following data sets contain the commonly-used system header files for z/OS XL C++:<sup>3</sup>

- CEE.SCEEH (standard C++ header files)
- CEE.SCEEH.H (standard header files)
- CEE.SCEEH.SYS.H (standard system header files)
- CEE.SCEEH.ARPA.H (standard internet operations headers)
- CEE.SCEEH.NET.H (standard network interface headers)
- CEE.SCEEH.NETINET.H (standard internet protocol headers)
- CEE.SCEEH.T (standard template definitions)
- CBC.SCLBH.H (class library header files)

To specify that the compiler search these data sets, code the option:

```
SEARCH('CEE.SCEEH.+','CBC.SCLBH.+')
```

I These header files are also in the z/OS UNIX System Services directories /usr/include and /usr/lpp/cbclib/include. To specify that the compiler search these directories, code the option:

```
SEARCH(/usr/include/,/usr/lpp/cbclib/include/)
```

This option is the default for the **cx** z/OS UNIX System Services command.

IBM supplies this option as input to the installation and customization of the compiler. Your system programmer can modify it as required for your installation.

---

## Chapter 8. Using the IPA Link step with z/OS XL C/C++ programs

Traditional optimizers only have the ability to optimize within a function (*intra-procedural optimization*) or at most within a compile unit (a single source file and its included header files). This is because traditional optimizers are only given one compile unit at a time.

*Interprocedural optimizations* are a class of optimizations that operate across function boundaries. IBM's Interprocedural Analysis (IPA) optimizer is designed to optimize complete modules at a time. This allows for increased optimization. By seeing more of the application at once, IPA is able to find more opportunities for optimization and this can result in much faster code.

In order to get a global module view of the application, IPA uses the following two pass process:

- The first pass is called an *IPA Compile*. During this pass, IPA collects all of the relevant information about the compile unit and stores it in the object file. This collected information is referred to as an IPA Object. You can optionally request that both an IPA object and a traditional object are created from an IPA Compile.
- The second pass is called the *IPA Link*. During this step, IPA acts like a traditional linker, and all object files, object libraries and side decks are fed to IPA so that it can optimize the entire module. The IPA Link step involves two separate optimizers. The IPA optimizer is run first and focuses optimizations across the module. IPA then breaks down the module into logical chunks called partitions and invokes the traditional optimizer with these partitions.

Whenever a compiler attempts to perform more optimizations, or looks at a larger portion of an application, more time, and more memory are required. Since IPA does more optimizations than either OPT(2) or OPT(3) and has a global view of the module, the compile time and memory used by the IPA Compile or Link process is more than that used by a traditional OPT(2) or OPT(3) compilation.

The first two sections of this chapter provide several examples on how to create modules (with a main) or DLLs using IPA. The third section discusses the Profile-Directed Feedback option that can be used with IPA to get even more performance benefits. The fourth section gives some reference information on IPA-specific subjects, like the IPA control file. The final section of this chapter provides some hints and tips for troubleshooting situations that come up when compiling and debugging IPA applications. All example source can be found in the sample data set SCCNSAM. The names of the sample data set members are given in each example below.

---

### Invoking IPA using the c89 and xlc utilities

You can invoke the IPA Compile step, the IPA Link step, or both. The step that c89 invokes depends upon the invocation parameters and type of files you specify. You must specify the I phase indicator along with the W option of the c89 utility.

If you invoke the c89 utility with at least one source file and the **-c** option and the **-WI** option, c89 automatically specifies the IPA(NOLINK) option and invokes the IPA Compile step. For example, the following command invokes the IPA Compile step for the source file hello.c:

```
c89 -c -WI hello.c
```

The syntax when using the xlc utility is:

```
c89 -c -qipa hello.c
```

If you invoke the c89 utility with the -WI option and with at least one object file, do not specify the -c option and do not specify any source files. c89 automatically specifies IPA(LINK) and automatically invokes the IPA Link step and the binder. For example, the following command invokes the IPA Link step and the binder, to create a program called hello:

```
c89 -o hello -WI hello.o
```

The syntax when using the xlc utility is:

```
c89 -o hello -qipa hello.o
```

If you invoke c89 with the -WI option and with at least one source file for compilation and any number of object files, and do not specify the -c c89 compiler option, **c89** automatically invokes the IPA Compile step once for each compilation unit and the IPA Link step once for the entire program. It then invokes the binder. For example, the following command invokes the IPA Compile step, the IPA Link step, and the binder to create a program called foo:

```
c89 -o foo -WI,object foo.c
```

The syntax when using the xlc utility is:

```
c89 -o foo -qipa=object foo.c
```

When linking an application built with IPA(PDF1), you must specify **-WI,PDF1** to ensure the application links correctly.

## Specifying options

When using c89, you can pass options to IPA, as follows:

- If you specify -WI, followed by IPA suboptions, c89 passes those suboptions to both the IPA Compile step and the IPA Link step (provided the IPA Link step is invoked)
- If you specify **-Wc**, followed by compiler options, c89 passes those options only to the IPA Compile step
- If you specify **-WI,I**, followed by compiler options, c89 passes those options only to the IPA Link step

The following is an example of passing options using the c89 utility:

```
c89 -02 -WI,noobject -Wc,source -WI,I,"maxmem(2048)" file.c
```

If you specify the previous command, you pass the IPA(NOOBJECT) and the SOURCE option to the IPA Compile step, and the MAXMEM(2048) option to both the IPA Compile and the IPA Link step.

The syntax when using the xlc utility is:

```
c89 -02 -qipa=noobject -qsource -qmaxmem=2048 hello.c
```

## Other considerations

The c89 and xlc utilities automatically generate all INCLUDE and LIBRARY IPA Link control statements.

IPA under c89 and xlc supports the following types of files:

- MVS PDS members
- Sequential data sets
- z/OS UNIX System Services files
- z/OS UNIX archive (.a) files

---

## Compiling under z/OS batch

To compile your C/C++ source program under batch, you can either use the cataloged procedures that IBM supplies, or write your own JCL statements.

## Using cataloged procedures for IPA Link

You can use one of the following IBM-supplied cataloged procedures.

**EDCI** Run the IPA Link step for a non-XPLINK 31-bit C program

**EDCXI**

Run the IPA Link step for a 31-bit or 64-bit XPLINK C program

**CBCI** Run the IPA Link step for a 31-bit non-XPLINK C++ program

**CBCXI**

Run the IPA Link step for a 31-bit or 64-bit XPLINK C++ program

---

## Creating a module with IPA

This section describes creating a module that contains the function `main`.

### Example 1. all C parts

The simplest case for IPA is an application that does not import any information from a DLL, and that is all in a single language that supports IPA. The following example covers this case. The sample programs mentioned here can be found in the sample data set with the member names given here.

The first example shows a simple application that is made up of three source files. The target is to compile it with `IPA(Level(2))` and `OPT(2)`. We also want a full inline report and pseudo-assembly listing. This is the only example where the full source will be shown.

## CCNGHI1.C

```
hello1.c:
    int seen_main;
    int seen_unused3;

    char *string1 = "Hello";
    char *stringU1 = "I'm not going to use this one!";

    int func2( char *);

    int main (void) {

        seen_main++;
        func2(string1);

        return 0;
    }

    float unused3( int a ) {
        seen_unused3++;
        return (float) a+seen_unused3;
    }
```

*Figure 26. hello1.c example source code*

## CCNGHI2.C

```
hello2.c:
    #include <stdio.h>

    int seen_func2;
    int seen_unused2;
    char *string2 = "world!";

    int func3 (char *);

    int func2( char * s1) {

        seen_func2++;

        printf("%s ",s1);

        return func3(string2);
    }

    double unused2(float x) {

        seen_unused2++;

        return x+ seen_unused2;
    }
```

*Figure 27. hello2.c example source code*



## CCNGHI3.C

```
hello3.c:
#include <stdio.h>

int seen_func3;
int seen_unused1;

int unused1(int x) {
    seen_unused1++;
    return x+ seen_unused1;
}

int func3( char * string2) {
    seen_func3++;
    printf("%s\n",string2);
    return seen_func3;
}
```

Figure 28. hello3.c example source code

### Building example 1. under UNIX System Services

For this example, the following table shows the mapping of SCCNSAM data set members to given file names:

| SCCNSAM member name | Name used in this example |
|---------------------|---------------------------|
| CCNGHI1             | hello1.c                  |
| CCNGHI2             | hello2.c                  |
| CCNGHI3             | hello3.c                  |

The following commands can be used to create this module under UNIX System Services:

```
c89 -c -2 -WI,NOBJECT,LIST hello1.c hello2.c hello3.c
c89 -2 -WI,MAP,LEVEL\{2\} -Wl,I,INLRPT,LIST\{hello.1st\} -o hello hello1.o
    hello2.o hello3.o
```

The first **c89** command performs an IPA Compile on hello1.c, hello2.c, and hello3.c. The options after -WI are IPA suboptions, which are described below (for further information on these suboptions, see “IPA | NOIPA” on page 124):

#### NOBJECT

This compile performs an IPA Compile (since **-c** was specified). This option specifies that only IPA objects should be generated by the IPA Compile step. The NOBJECT suboption will reduce the size of the output object files. It ensures that only the IPA object is written to the output file. The NOBJECT option should be used unless the traditional object is needed for debugging purposes or the object file may be passed in a non-IPA Link. NOBJECT significantly shortens the overall compile time.

**LIST** This option tells IPA to save enough information that a listing with source file and line number information can be generated during the IPA(LINK) phase.

**Note:** -2 was specified on the IPA Compile step. While it is not strictly necessary, it does allow for faster code to be generated in some cases.

The second **c89** command does the IPA Link processing. Since **-WI** and **WI,I** were specified with **.o** files, **c89** automatically turns on the **LINK** suboption of **IPA**. The **-WI** suboptions within this command are those that are valid for **IPA(LINK)**:

**MAP** Generates additional information in the listing that shows where variables and data came from. For more information on specifying **IPA(MAP)**, see “Using the IPA Link step listing” on page 271.

**LEVEL(2)**

Specifies that the maximum level of IPA optimization is to be used

The **-WI,I** option keyword specifies that these are compiler options that are to be passed to the **IPA(LINK)** step. Chapter 4, “Compiler Options,” on page 45 documents the compiler options and whether they are valid during the IPA Link step. **INLRPT** triggers an inline report that shows the inlining that was done by **IPA**. **LIST** triggers a pseudo assembly listing for each partition.

**Notes:**

1. In this case, the name of the output file for the listing was provided as a suboption.
2. Even with **IPA**, the **-2** or **-3** option should be used to specify the opt level that the traditional optimizer should be called with.

This example shows the advantage of using discrete listing options (**MAP**, **LIST**, **INLRPT**) over using **-V**. **-V** may give you so much information that it creates a huge file. By using the individual options, you get more control and (with **LIST**) the ability to route the listing to the location of your choice without redirecting the output of your **c89** command.

**Building example 1. in batch**

For this example the following table shows the mapping of **SCCNSAM** data set members to given file names:

| <b>SCCNSAM member name</b> | <b>Name used in this example</b> |
|----------------------------|----------------------------------|
| CCNGHI1                    | IPA.SOURCE(HELLO1)               |
| CCNGHI2                    | IPA.SOURCE(HELLO2)               |
| CCNGHI3                    | IPA.SOURCE(HELLO3)               |

The following **JCL** can be used to create an object deck that can be linked to create the module (the link **JCL** is omitted for brevity):

```

/USERID1A JOB (127A,0329),'$MEM$',
// MSGLEVEL=(2,0),MSGCLASS=S,CLASS=A,
// NOTIFY=USERID1,REGION=1024M
//PROC JCLLIB ORDER=(CBC.SCCNPRC)
/*-----
/* IPA Compile Step for hello1.c
/*-----
//C001F336 EXEC EDCC,
//          INFILE='USERID1.IPA.SOURCE(HELLO1)',
//          OUTFILE='USERID1.IPA.OBJECT(HELLO1),DISP=SHR',
//          CPARM='OPTFILE(DD:OPTIONS)'
//OPTIONS DD *
          IPA(NOOBJECT,LIST) RENT LONG OPT(2)

```

```

/*
/*-----
/* IPA Compile Step for hello2.c
/*-----
//C001F336 EXEC EDCC,
//      INFILE='USERID1.IPA.SOURCE(HELLO2)',
//      OUTFILE='USERID1.IPA.OBJECT(HELLO2),DISP=SHR',
//      CPARM='OPTFILE(DD:OPTIONS)'
//OPTIONS DD *
//      IPA(NOOBJECT,LIST) RENT LONG OPT(2)
/*
/*-----
/* IPA Compile Step for hello3.c
/*-----
//C001F336 EXEC EDCC,
//      INFILE='USERID1.IPA.SOURCE(HELLO3)',
//      OUTFILE='USERID1.IPA.OBJECT(HELLO3),DISP=SHR',
//      CPARM='OPTFILE(DD:OPTIONS)'
//OPTIONS DD *
//      IPA(NOOBJECT,LIST) RENT LONG OPT(2)
/*
/*-----
/* IPA Link Step for the hello module
/*-----
//C001F336 EXEC EDCI,
//      OUTFILE='USERID1.IPALINK.OBJECT(HELLO),DISP=SHR',
//      IPARM='OPTFILE(DD:OPTIONS)'
/* The following line sets up an input file that just includes all
/* the IPA Compile Step object files.
//SYSIN DD DATA,DLM='>'
//      INCLUDE OBJECT(HELLO1,HELLO2,HELLO3)
/>
/* The following line redirects the listing
//SYSPRT DD DSN=USERID1.IPA.LISTING(HELLO),DISP=SHR
/* These are the options used
//OPTIONS DD DATA,DLM='>'
//      IPA(LINK,MAP,LEVEL(2)) OPT(2) INLRPT LIST RENT LONGNAME
/>
/* The following line gives the object library
//OBJECT DD DSN=USERID1.IPA.OBJECT,DISP=SHR

```

The options used are the same as those given in the UNIX System Services example above with the exception that IPA(LINK) should be explicitly specified, and RENT, and LONGNAME are not the default for C in batch so they also need to be specified. This sample JCL was created using the standard cataloged procedures shipped with the z/OS XL C/C++ compiler.

The generated file hello.lst is as follows:

\*\*\*\*\* PROLOG \*\*\*\*\*

Compile Time Library . . . . . : 41080000

Command options:

Primary input name. . . . . : DD:SYSIN

Compiler options. . . . . : \*IPA(LINK,MAP,NOREFMAP,LEVEL(2),DUP,ER,NONCAL,NOUPCASE,NOPDF1,NOPDF2,NOPDFNAME,NOCONTROL)  
 : \*NOGONUMBER \*NOHOT \*NOALIAS \*TERMINAL \*LIST \*NOXREF \*NOATTR  
 : \*NOOFFSET \*MEMORY \*NOCSECT \*LIBANSI \*FLAG(I)  
 : \*NOTEST(NOSYM,NOBLOCK,NOLINE,NOPATH,HOOK) \*OPTIMIZE(2)  
 : \*INLINE(AUTO,REPORT,1000,8000) \*OPTFILE(DD:OPTIONS) \*NOSERVICE \*NOOE  
 : \*NOLOCALE \*HALT(16) \*NOGOFF

\*\*\*\*\* END OF PROLOG \*\*\*\*\*

\*\*\*\*\* OBJECT FILE MAP \*\*\*\*\*

| *ORIGIN | IPA | FILE ID | FILE NAME                          |
|---------|-----|---------|------------------------------------|
| P       |     | 1       | //DD:SYSIN                         |
| PI      | Y   | 2       | USERID1.IPA.OBJECT(HELLO1)         |
| PI      | Y   | 3       | USERID1.IPA.OBJECT(HELLO2)         |
| PI      | Y   | 4       | USERID1.IPA.OBJECT(HELLO3)         |
| L       |     | 5       | TSCTEST.CEEZ180.SCEELKED(PRINTF)   |
| L       |     | 6       | TSCTEST.CEEZ180.SCEELKED(CEESG003) |

ORIGIN: P=primary input PI=primary INCLUDE SI=secondary INCLUDE IN=internal  
 A=automatic call U=UPCASE automatic call R=RENAME card L=C Library

\*\*\*\*\* END OF OBJECT FILE MAP \*\*\*\*\*

Figure 29. Example of an IPA listing (Part 1 of 6)

\*\*\*\*\* COMPILER OPTIONS MAP \*\*\*\*\*

```

SOURCE FILE ID   COMPILE OPTIONS
1
*AGGRCOPY(NOOVERLAP) *NOALIAS *ANSIALIAS *ARCH(5) *ARGPARSE
*CHARSET(BIAS=EBCDIC,LIB=EBCDIC) *NOCOMPACT *NOCOMPRESS *NODLL(NOCALLBACKANY) *ENV(MVS)
*EXECOPS *FLOAT(HEX,FOLD,AFP) *NOGONUMBER *NOIGNERRNO *ILP32 *NOINITAUTO
*IPA(NOLINK,NOOBJECT,COMPRESS) *NOLIBANSI *NOLIST *NOLOCALE *LONGNAME
*MAXMEM(2097152) *OPTIMIZE(2) *PLIST(HOST) *REDIR *RENT *NOROCONST *SPILL(128)
*NOSTART *STRICT *NOSTRICT_INDUCTION *NOTEST *TUNE(5) *NOXPLINK *NOXREF

2
*AGGRCOPY(NOOVERLAP) *NOALIAS *ANSIALIAS *ARCH(5) *ARGPARSE
*CHARSET(BIAS=EBCDIC,LIB=EBCDIC) *NOCOMPACT *NOCOMPRESS *NODLL(NOCALLBACKANY) *ENV(MVS)
*EXECOPS *FLOAT(HEX,FOLD,AFP) *NOGONUMBER *NOIGNERRNO *ILP32 *NOINITAUTO
*IPA(NOLINK,NOOBJECT,COMPRESS) *NOLIBANSI *NOLIST *NOLOCALE *LONGNAME
*MAXMEM(2097152) *OPTIMIZE(2) *PLIST(HOST) *REDIR *RENT *NOROCONST *SPILL(128)
*NOSTART *STRICT *NOSTRICT_INDUCTION *NOTEST *TUNE(5) *NOXPLINK *NOXREF

3
*AGGRCOPY(NOOVERLAP) *NOALIAS *ANSIALIAS *ARCH(5) *ARGPARSE
*CHARSET(BIAS=EBCDIC,LIB=EBCDIC) *NOCOMPACT *NOCOMPRESS *NODLL(NOCALLBACKANY) *ENV(MVS)
*EXECOPS *FLOAT(HEX,FOLD,AFP) *NOGONUMBER *NOIGNERRNO *ILP32 *NOINITAUTO
*IPA(NOLINK,NOOBJECT,COMPRESS) *NOLIBANSI *NOLIST *NOLOCALE *LONGNAME
*MAXMEM(2097152) *OPTIMIZE(2) *PLIST(HOST) *REDIR *RENT *NOROCONST *SPILL(128)
*NOSTART *STRICT *NOSTRICT_INDUCTION *NOTEST *TUNE(5) *NOXPLINK *NOXREF

```

\*\*\*\*\* END OF COMPILER OPTIONS MAP \*\*\*\*\*

\*\*\*\*\* INLINE REPORT \*\*\*\*\*

IPA Inline Report (Summary)

```

Reason:  P : #pragma noline was specified for this routine
         F : #pragma inline was specified for this routine
         A : Automatic inlining
         C : Partition conflict
         N : Not IPA Object
         - : No reason
Action:  I : Routine is inlined at least once
         L : Routine is initially too large to be inlined
         T : Routine expands too large to be inlined
         C : Candidate for inlining but not inlined
         N : No direct calls to routine are found in file (no action)
         U : Some calls not inlined due to recursion or parameter mismatch
         - : No action
Status:  D : Internal routine is discarded
         R : A direct call remains to internal routine (cannot discard)
         A : Routine has its address taken (cannot discard)
         E : External routine (cannot discard)
         - : Status unchanged
Calls/I  : Number of calls to defined routines / Number inline
Called/I : Number of times called / Number of times inlined

Reason Action Status Size (init) Calls/I Called/I Name
-----
A      I      D      0 (40)      2/1      1/1      func2
A      I      D      0 (32)      1/0      1/1      func3
A      N      -      68 (28)     1/1      0        main
N      -      E      0          0        2/0      PRINTF
Mode = AUTO Inlining Threshold = 1000 Expansion Limit = 8000

```

Figure 29. Example of an IPA listing (Part 2 of 6)

## IPA Inline Report (Call Structure)

```

Defined Subprogram   : main
  Calls To(1,1)     : func2(1,1)
  Called From       : 0

Defined Subprogram   : func2
  Calls To(2,1)     : func3(1,1)
                   : PRINTF(1,0)
  Called From(1,1)  : main(1,1)

Defined Subprogram   : PRINTF
  Calls To          : 0
  Called From(2,0)  : func3(1,0)
                   : func2(1,0)

Defined Subprogram   : func3
  Calls To(1,0)     : PRINTF(1,0)
  Called From(1,1)  : func2(1,1)

```

\*\*\*\*\* END OF INLINE REPORT \*\*\*\*\*

\*\*\*\*\* PARTITION MAP \*\*\*\*\*

## PARTITION 1 OF 1

## PARTITION SIZE:

Actual: 5900  
Limit: 1572864

## PARTITION CSECT NAMES:

Code: none  
Static: none  
Test: none

## PARTITION DESCRIPTION:

Additional partition

## COMPILER OPTIONS FOR PARTITION 1:

```

*AGGRCOPY(NOOVERLAP)  *NOALIAS    *ARCH(5)    *ARGPARSE   *ATTR       *CHARSET(BIAS=EBCDIC,LIB=EBCDIC)  *NOCOMPACT
*NOCOMPRESS          *NOCSECT    *NODLL      *ENV(MVS)   *EXECOPS    *FLOAT(HEX,FOLD,AFP)              *NOGOFF      *NOGONUMBER *NOIGNERRNO
*ILP32              *NOINITAUTO *IPA(LINK)  *LIBANSI    *LIST       *NOLOCALE  *LONGNAME   *MAXMEM(2097152) *OPTIMIZE(2)
*PLIST(HOST)        *REDIR      *RENT       *NOROCONST  *SPILL(128) *START     *STRICT     *NOSTRICT_INDUCTION *NOTEST
*TUNE(5)            *NOXPLINK  *XREF

```

## SYMBOLS IN PARTITION 1:

| *TYPE | FILE ID | SYMBOL     |
|-------|---------|------------|
| D     | 1       | seen_main  |
| D     | 1       | string1    |
| D     | 2       | seen_func2 |
| D     | 2       | string2    |
| D     | 3       | seen_func3 |
| F     | 1       | main       |

TYPE: F=function D=data

## SOURCE FILES FOR PARTITION 1:

\*ORIGIN FILE ID SOURCE FILE NAME  
5694-A01 V1.8 z/OS XL C/C++ IPA

Partition 1

02/28/2006 09:50:26 Page 6

```

P      1  //'USERID1.IPA.SOURCE(HELLO1)'
P      2  //'USERID1.IPA.SOURCE(HELLO2)'
P      3  //'USERID1.IPA.SOURCE(HELLO3)'

```

ORIGIN: P=primary input PI=primary INCLUDE

\*\*\*\*\* END OF PARTITION MAP \*\*\*\*\*

Figure 29. Example of an IPA listing (Part 3 of 6)

```

OFFSET OBJECT CODE      LINE# FILE#  P S E U D O  A S S E M B L Y  L I S T I N G
Timestamp and Version Information
000000 F2F0 F0F6                =C'2006'          Compiled Year
000004 F0F2 F2F8                =C'0228'          Compiled Date MMDD
000008 F0F9 F5F0 F1F0          =C'095010'        Compiled Time HHMMSS
00000E F0F1 F0F8 F0F0          =C'010800'        Compiler Version
Timestamp and Version End

```

```

OFFSET OBJECT CODE      LINE# FILE#  P S E U D O  A S S E M B L Y  L I S T I N G
000018                000010 | 1 main DS 0D
000018 47F0 F022          000010 | 1 B 34(,r15)
00001C 01C3C5C5          CEE eyecatcher
000020 000000A8          DSA size
000024 000000E8          =A(PPA1-main)
000028 47F0 F001          000010 | 1 B 1(,r15)
00002C 58F0 C31C          000010 | 1 L r15,796(,r12)
000030 184E                000010 | 1 LR r4,r14
000032 05EF                000010 | 1 BALR r14,r15
000034 00000000          =F'0'
000038 07F3                000010 | 1 BR r3
00003A 90E7 D00C          000010 | 1 STM r14,r7,12(r13)
00003E 58E0 D04C          000010 | 1 L r14,76(,r13)
000042 4100 E0A8          000010 | 1 LA r0,168(,r14)
000046 5500 C314          000010 | 1 CL r0,788(,r12)
00004A 4130 F03A          000010 | 1 LA r3,58(,r15)
00004E 4720 F014          000010 | 1 BH 20(,r15)
000052 58F0 C280          000010 | 1 L r15,640(,r12)
000056 90F0 E048          000010 | 1 STM r15,r0,72(r14)
00005A 9210 E000          000010 | 1 MVI 0(r14),16
00005E 50D0 E004          000010 | 1 ST r13,4(,r14)
000062 18DE                000010 | 1 LR r13,r14
000064                End of Prolog

000064 5820 C1F4          000000 | L r2,_CEECAA(,r12,500)
000068 5840 308E          000012 | 1 L r4,=Q(@STATIC)(,r3,142)
00006C C050 0000 003E 000000 | LARL r5,F'62'
000072 58F0 3092          000013 | 2 + L r15,=V(printf)(,r3,146)
000076 4110 D098          000013 | 2 + LA r1,#MX_TEMP1(,r13,152)
00007A 5804 2000          000012 | 1 L r0,seen_main(r4,r2,0)
00007E 58E4 2008          000011 | 2 + L r14,seen_func2(r4,r2,8)
000082 A70A 0001          000012 | 1 AHI r0,H'1'
000086 A7EA 0001          000011 | 2 + AHI r14,H'1'
00008A 5864 2004          000011 | 2 + L r6,string1(r4,r2,4)
00008E 4170 500F          000013 | 2 + LA r7,+CONSTANT_AREA(,r5,15)
000092 5004 2000          000012 | 1 ST r0,seen_main(r4,r2,0)
000096 50E4 2008          000011 | 2 + ST r14,seen_func2(r4,r2,8)
00009A 5070 D098          000013 | 2 + ST r7,#MX_TEMP1(,r13,152)
00009E 5060 D09C          000013 | 2 + ST r6,#MX_TEMP1(,r13,156)
0000A2 05EF          000013 | 2 + BALR r14,r15
0000A4 5804 2010          000015 | 3 + L r0,seen_func3(r4,r2,16)
0000A8 A70A 0001          000015 | 3 + AHI r0,H'1'
0000AC 5004 2010          000015 | 3 + ST r0,seen_func3(r4,r2,16)
0000B0 5804 200C          000015 | 3 + L r0,string2(r4,r2,12)
0000B4 5000 D09C          000017 | 3 + ST r0,#MX_TEMP1(,r13,156)
0000B8 4100 5013          000017 | 3 + LA r0,+CONSTANT_AREA(,r5,19)
0000BC 58F0 3092          000017 | 3 + L r15,=V(printf)(,r3,146)
0000C0 5000 D098          000017 | 3 + ST r0,#MX_TEMP1(,r13,152)
0000C4 4110 D098          000017 | 3 + LA r1,#MX_TEMP1(,r13,152)
0000C8 05EF          000017 | 3 + BALR r14,r15
0000CA 41F0 0000          000015 | 1 LA r15,0
0000CE                000015 | 1 @1L3 DS 0H

0000CE                Start of Epilog
0000CE 180D                000016 | 1 LR r0,r13
0000D0 58D0 D004          000016 | 1 L r13,4(,r13)

```

Figure 29. Example of an IPA listing (Part 4 of 6)

| OFFSET | OBJECT CODE | LINE#  | FILE# | PSEUDO | ASSEMBLY      | LISTING |
|--------|-------------|--------|-------|--------|---------------|---------|
| 0000D4 | 58E0 D00C   | 000016 | 1     | L      | r14,12(,r13)  |         |
| 0000D8 | 9827 D01C   | 000016 | 1     | LM     | r2,r7,28(r13) |         |
| 0000DC | 051E        | 000016 | 1     | BALR   | r1,r14        |         |
| 0000DE | 0707        | 000016 | 1     | NOPR   | 7             |         |

```

0000E0          Start of Literals
0000E0 00000000          =Q(@STATIC)
0000E4 00000000          =V(sprintf)
0000E8          End of Literals

```

```

*** General purpose registers used: 1111111100001111
*** Floating point registers used: 1111111100000000
*** Size of register spill area: 128(max) 0(used)
*** Size of dynamic storage: 168
*** Size of executable code: 200

```

## Constant Area

```

0000E8 C8859393 96000000 A6969993 845A006C |Hello...world!.|
0000F8 A240006C A21500 |s .%s..|

```

| OFFSET | OBJECT CODE | LINE# | FILE# | PSEUDO | ASSEMBLY | LISTING |
|--------|-------------|-------|-------|--------|----------|---------|
|--------|-------------|-------|-------|--------|----------|---------|

```

PPA1: Entry Point Constants
000100 1CCEA106          =F'483303686'      Flags
000104 00000128          =A(PPA2-main)
000108 00000000          =F'0'              No PPA3
00010C 00000000          =F'0'              No EPD
000110 FFC00000          =F'-4194304'      Register save mask
000114 00000000          =F'0'              Member flags
000118 90              =AL1(144)          Flags
000119 00000000          =AL3(0)            Callee's DSA use/8
00011C 0040          =H'64'             Flags
00011E 0012          =H'18'             Offset/2 to CDL
000120 00000000          =F'0'              Reserved
000124 50000064          =F'1342177380'    CDL function length/2
000128 FFFFFFFF18          =F'-232'           CDL function EP offset
00012C 38260000          =F'942014464'     CDL prolog
000130 4009005B          =F'1074331739'    CDL epilog
000134 00000000          =F'0'              CDL end
000138 0004 ****          AL2(4),C'main'

```

PPA1 End

## PPA2: Compile Unit Block

```

000140 0300 2202          =F'50340354'      Flags
000144 FFFF FEC0          =A(CEESTART-PPA2)
000148 0000 0000          =F'0'              No PPA4
00014C FFFF FEC0          =A(TIMESTAMP-PPA2)
000150 0000 0000          =F'0'              No primary
000154 0000 0000          =F'0'              Flags

```

PPA2 End

Figure 29. Example of an IPA listing (Part 5 of 6)



## EXTERNAL SYMBOL DICTIONARY

| TYPE | ID | ADDR   | LENGTH | NAME     |
|------|----|--------|--------|----------|
| SD   | 1  | 000000 | 000158 | @STATICP |
| PR   | 2  | 000000 | 000014 | @STATIC  |
| LD   | 0  | 000018 | 000001 | main     |
| ER   | 3  | 000000 |        | CEESG003 |
| ER   | 4  | 000000 |        | PRINTF   |
| ER   | 5  | 000000 |        | CEESTART |
| SD   | 6  | 000000 | 000008 | @PPA2    |
| SD   | 7  | 000000 | 00000C | CEEMAIN  |
| ER   | 8  | 000000 |        | EDCINPL  |

## \*\*\*\*\* SOURCE FILE MAP \*\*\*\*\*

| *ORIGIN | OBJECT  | SOURCE  | SOURCE FILE NAME  |
|---------|---------|---------|---|
| P       | FILE ID | FILE ID |   |
| P       | 2       | 1       | //'USERID1.IPA.SOURCE(HELLO1)'<br>- Compiled by 15694A01 1800<br>on 02/28/2006 09:50:10 |
| P       | 3       | 2       | //'USERID1.IPA.SOURCE(HELLO2)'<br>- Compiled by 15694A01 1800<br>on 02/28/2006 09:50:17 |
| P       | 4       | 3       | //'USERID1.IPA.SOURCE(HELLO3)'<br>- Compiled by 15694A01 1800<br>on 02/28/2006 09:50:23 |

ORIGIN: P=primary input PI=primary INCLUDE

## \*\*\*\*\* END OF SOURCE FILE MAP \*\*\*\*\*

## \*\*\*\*\* MESSAGE SUMMARY \*\*\*\*\*

| TOTAL | UNRECOVERABLE | SEVERE | ERROR | WARNING | INFORMATIONAL |
|-------|---------------|--------|-------|---------|---------------|
|       | (U)           | (S)    | (E)   | (W)     | (I)           |
| 0     | 0             | 0      | 0     | 0       | 0             |

## \*\*\*\*\* END OF MESSAGE SUMMARY \*\*\*\*\*

## \*\*\*\*\* END OF COMPILATION \*\*\*\*\*

Figure 29. Example of an IPA listing (Part 6 of 6)

After a traditional compile, there are three object files, six external functions, and eight external variables. Without a global view of the application, the compiler looks at hello1.c and cannot tell that unused3 is really unused and that stringU1 is never referenced. So the compiler has to keep all of the code and variables. IPA has the global view so it can remove the unused functions. As you can see from listing file above, only the main function remains. The other functions were inlined, and because they were not exported, and their address was not taken, they were removed.

## Example 2. all C parts built with XPLINK

The second example is a variation of the first example. The purpose of this example is to show how easy it is to build an application with both XPLINK and IPA. To simplify the options even more, this example will not generate any listings. Please refer to the appropriate sections of “Example 1. all C parts” on page 331 to map the given names to the members of the SCCNSAM data set.

### Building example 2. under UNIX System Services

The only addition to the IPA Compile step is the required addition of the XPLINK option. The GOFF option has also been added (this option defaults on when XPLINK is specified) for convenience purposes.

```
c89 -c -2 -WI,N00BJECT -Wc,XPLINK,G0FF hello1.c hello2.c hello3.c
```

For the IPA Link step, the changes are similar to the compile step, and the basic changes that must be done to use XPLINK under UNIX System Services. The option **-WI,XPLINK** is added to guide **c89** to include the XPLINK libraries in the IPA Link step.

```
c89 -2 -WI,LEVEL\{2\} -WI,XPLINK -o hello hello1.o
      hello2.o hello3.o
```

### Building example 2. in batch

In batch, the same basic changes are made. XPLINK and GOFF are added to the IPA Compile steps and the XPLINK proc EDCXI is used instead of EDCI. A few extra includes (CELHS003,CELHS001) are placed in the IPA input to allow IPA to resolve XPLINK library references. This job will result in an object deck that can then be linked to create the module.

```
//USERID1A JOB (127A,0329),'$MEM$',
// MSGLEVEL=(2,0),MSGCLASS=S,CLASS=A,
// NOTIFY=USERID1,REGION=1024M
//PROC JCLLIB ORDER=(CBC.SCCNPRC)
//*-----
//* IPA Compile Step for hello1.c
//*-----
//C001F336 EXEC EDCC,
//      INFILE='USERID1.IPA.SOURCE(HELLO1)',
//      OUTFILE='USERID1.IPA.OBJECT(HELLOX1),DISP=SHR',
//      CPARAM='OPTFILE(DD:OPTIONS)'
//OPTIONS DD *
//      IPA(NOOBJECT) RENT LONG OPT(2) XPLINK GOFF
/*
//*-----
//* IPA Compile Step for hello2.c
//*-----
//C001F336 EXEC EDCC,
//      INFILE='USERID1.IPA.SOURCE(HELLO2)',
//      OUTFILE='USERID1.IPA.OBJECT(HELLOX2),DISP=SHR',
//      CPARAM='OPTFILE(DD:OPTIONS)'
//OPTIONS DD *
//      IPA(NOOBJECT) RENT LONG OPT(2) XPLINK GOFF
/*
//*-----
//* IPA Compile Step for hello3.c
//*-----
//C001F336 EXEC EDCC,
//      INFILE='USERID1.IPA.SOURCE(HELLO3)',
//      OUTFILE='USERID1.IPA.OBJECT(HELLOX3),DISP=SHR',
//      CPARAM='OPTFILE(DD:OPTIONS)'
//OPTIONS DD *
//      IPA(NOOBJECT) RENT LONG OPT(2) XPLINK GOFF
/*
//*-----
//* IPA Link Step for the hello module
//*-----
//C001F336 EXEC EDCXI,
//      OUTFILE='USERID1.IPALINK.OBJECT(HELLOXP),DISP=SHR',
//      IPARM='OPTFILE(DD:OPTIONS)'
//* The following line sets up an input file that just includes all
//* the IPA Compile Step object files.
//SYSIN DD DATA,DLM='>'
//      INCLUDE OBJECT(HELLOX1,HELLOX2,HELLOX3)
//      INCLUDE SYSLIB(CELHS003,CELHS001)
/>
//* These are the options used
//OPTIONS DD DATA,DLM='>'
//      IPA(LINK,LEVEL(2)) OPT(2) RENT LONGNAME
//      XPLINK GOFF
```

```

/>
/** The following line gives the object library
//OBJECT DD DSN=USERID1.IPA.OBJECT,DISP=SHR

```

---

## Creating a DLL with IPA

This section gives several examples, which describe the aspects of building a simple DLL, as well as how to use some of the advanced IPA features to build a faster DLL. By default, IPA will try to remove unused code and variables (even global variables). In DLL situations, (or with exported variables) this ability becomes limited. For modules with a main function, IPA can build a function call tree and determine which functions are or may be called. This list of functions is used to remove unused functions and variables. For DLLs, IPA must treat the list of exported functions as potential entry points, and all exported variables as used. For this reason, the use of the EXPORTALL compiler option is not recommended. IPA provides a control file option that allows you to specify exactly which functions and variables you wish to be exported. This gives the programmer who cannot change the source another way to avoid EXPORTALL. For an example of this, please see "Example 2. using the IPA control file" on page 345.

### Example 1. a mixture of C and C++

For this example, the following table shows the mapping of SCCNSAM data set members to given file names. The main program is provided to allow you to run the created DLL, it is not used in the following example.

| SCCNSAM member name | Name used in this example |
|---------------------|---------------------------|
| CCNGID1             | GlobInfo.h                |
| CCNGID2             | UserInt.h                 |
| CCNGID3             | UserInterface.C           |
| CCNGID4             | c_DLL.c                   |
| CCNGID5             | c_DLL.h                   |
| CCNGID6             | cpp_DLL.C                 |
| CCNGID7             | cpp_DLL.h                 |
| CCNGIDM             | main.C                    |

This example involves the creation of a C/C++ DLL. The DLL is built from one C source file and two C++ source files. For your convenience, a main SCCNSAM(CCNGIDM) is provided so that the program can be executed. Instructions to build the main will not be given in this example. In general, IPA DLLs are created in the same manner as IPA modules with the extra commands for DLLs added in for the IPA Link step.

#### Building example 1. under UNIX System Services

First, IPA must compile each source file. Since NOOBJECT is the default, it is not specifically mentioned in this example. -WI is specified to trigger an IPA Compile.

```

c89 -c -2 -WI -Wc,"FLAG(I),DLL" c_DLL.c
c++ -c -2 -WI -Wc,"FLAG(I)" -+ cpp_DLL.C
c++ -c -2 -WI -Wc,"FLAG(I),EXPORTALL" -+ UserInterface.C

```

If you are using the xlc utility, the same IPA Compile is invoked by the following command lines:

```

c89 -c -O2 -qipa -qflag=i -qdll          c_DLL.c
c++ -c -O2 -qipa -qflag=i                +- cpp_DLL.C
c++ -c -O2 -qipa -qflag=i -qexportall +- UserInterface.C

```

Next, the IPA Link step is performed. In this case, IPA level(1) optimizations are used:

```

c++ -2 -WI,"LEVEL(1)" -Wl,I,DLL -Wl,DLL -o mydll
    UserInterface.o c_DLL.o cpp_DLL.o

```

The LEVEL(1) suboption is fed to IPA. The DLL option is given to the traditional optimizer using -Wl,I,DLL and the usual linker command for DLLs is given.

If you are using the xlc utility, the same IPA Link is invoked by the following command line:

```

c++ -O2 -qipa=level=1 -qdll -Wl,DLL -o mydll
    UserInterface.o c_DLL.o cpp_DLL.o

```

### Building example 1. under batch

For this example, the following table shows the mapping of SCCNSAM data set members to given PDS member names. The main program is provided to allow you to run the created DLL, it is not used in the following example.

| SCCNSAM member name | Name used in this example |
|---------------------|---------------------------|
| CCNGID1             | IPA.H(GLOBINFO)           |
| CCNGID2             | IPA.H(USERINT)            |
| CCNGID3             | IPA.SOURCE(USERINT)       |
| CCNGID4             | IPA.SOURCE(CDLL)          |
| CCNGID5             | IPA.H(C@DLL)              |
| CCNGID6             | IPA.SOURCE(CPPDLL)        |
| CCNGID7             | IPA.H(CPP@DLL)            |
| CCNGIDM             | IPA.SOURCE(MAIN)          |

```

//USERID1A JOB (127A,0329),'$MEM$',
// MSGLEVEL=(2,0),MSGCLASS=S,CLASS=A,
// NOTIFY=USERID1,REGION=1024M
//PROC JCLLIB ORDER=(CBC.SCCNPRC)
//*-----
//* IPA Compile Step for CDLL
//*-----
//C001F336 EXEC EDCC,
//          INFILE='USERID1.IPA.SOURCE(CDLL)',
//          OUTFILE='USERID1.IPA.OBJECT(CDLL),DISP=SHR',
//          CPARM='OPTFILE(DD:OPTIONS)'
//OPTIONS DD *
//          IPA(NOOBJECT) RENT LONG OPT(2) DLL
//          LSEARCH('USERID1.IPA.+')
//          SEARCH('CEE.SCEEH.+')
//*
//*-----
//* IPA Compile Step for CPPDLL
//*-----
//C001F336 EXEC CBCC,
//          INFILE='USERID1.IPA.SOURCE(CPPDLL)',
//          OUTFILE='USERID1.IPA.OBJECT(CPPDLL),DISP=SHR',
//          CPARM='OPTFILE(DD:OPTIONS)'
//OPTIONS DD *
//          IPA(NOOBJECT) OPT(2)
//          LSEARCH('USERID1.IPA.+')

```

```

SEARCH('CEE.SCEEH.+')
/*
/*-----
/* IPA Compile Step for USERINT
/*-----
//C001F336 EXEC CBCC,
//      INFILE='USERID1.IPA.SOURCE(USERINT)',
//      OUTFILE='USERID1.IPA.OBJECT(USERINT),DISP=SHR',
//      CPARM='OPTFILE(DD:OPTIONS)'
//OPTIONS DD *
//      IPA(NOOBJECT) OPT(2) EXPORTALL
//      LSEARCH('USERID1.IPA.+')
//      SEARCH('CEE.SCEEH.+')
/*
/*-----
/* IPA Link Step for the hello module
/*-----
//C001F336 EXEC CBCI,
//      OUTFILE='USERID1.IPALINK.OBJECT(MYDLL),DISP=SHR',
//      IPARM='OPTFILE(DD:OPTIONS)'
/* The following line sets up an input file that just includes all
/* the IPA Compile Step object files.
//SYSIN DD DATA,DLM='>'
//      INCLUDE OBJECT(USERINT,CDLL,CPDLL)
//      INCLUDE SYSLIB(C128,IOSTREAM,COMPLEX)
/>
/* These are the options used
//OPTIONS DD DATA,DLM='>'
//      IPA(LINK,MAP,LEVEL(1)) OPT(2) RENT LONGNAME
/>
/* The following line gives the object library
//OBJECT DD DSN=USERID1.IPA.OBJECT,DISP=SHR

```

## Example 2. using the IPA control file

The following example uses the IPA control file to choose which functions should be exported from UserInterface.C. This allows the IPA Compile step to be done without the EXPORTALL option. The first step is to construct an IPA control file. The function names appearing in the IPA control file must be mangled names if the names in the source file are going to be mangled by the compiler. The file content is as follows:

```

export=get_user_input__7UIclassFv,
        get_user_sort_method__7UIclassFRi,
        call_user_sort_method__7UIclassFi,
        print_sort_result__7UIclassFv

```

Please refer to the appropriate sections of “Example 1. a mixture of C and C++” on page 343 to map the given names to the members of the SCCNSAM data set.

### Building example 2. under UNIX System Services

First, IPA must compile each source file using the following commands:

```

c89 -c -2 -WI -Wc,"FLAG(I),DLL" c_DLL.c
c++ -c -2 -WI -Wc,"FLAG(I)" -+ cpp_DLL.C
c++ -c -2 -WI -Wc,"FLAG(I)" -+ UserInterface.C

```

If you are using the xlc utility, the same IPA Compile is invoked by the following command lines:

```

c89 -c -02 -qipa -qflag=i -qdll c_DLL.c
c++ -c -02 -qipa -qflag=i -+ cpp_DLL.C
c++ -c -02 -qipa -qflag=i -+ UserInterface.C

```

Next, the IPA Link step is run to specify a control file:

```
c++ -2 -WI,"LEVEL(1),CONTROL(myd11.cnt1)" -W1,I,DLL -W1,DLL -o myd11
  UserInterface.o c_DLL.o cpp_DLL.o
```

If you are using the xlc utility, the same IPA Link is invoked by the following command line:

```
c++ -O2 -qipa=level=1 -qipa=control=myd11.cnt1 -qd11 -W1,DLL -o myd11
  UserInterface.o c_DLL.o cpp_DLL.o
```

This creates a DLL where only the specified functions are exported from UserInterface.C.

## Building example 2. in batch

```
//USERID1A JOB (127A,0329),'$MEM$',
// MSGLEVEL=(2,0),MSGCLASS=S,CLASS=A,
// NOTIFY=USERID1,REGION=1024M
//PROC JCLLIB ORDER=(CBC.SCCNPRC)
//*-----
//* IPA Compile Step for CDLL
//*-----
//C001F336 EXEC EDCC,
//      INFILE='USERID1.IPA.SOURCE(CDLL)',
//      OUTFILE='USERID1.IPA.OBJECT(CDLL),DISP=SHR',
//      CPARAM='OPTFILE(DD:OPTIONS)'
//OPTIONS DD *
//      IPA(NOOBJECT) RENT LONG OPT(2) DLL
//      LSEARCH('USERID1.IPA.+')
//      SEARCH('CEE.SCEEH.+')
/*
//*-----
//* IPA Compile Step for CPPDLL
//*-----
//C001F336 EXEC CBCC,
//      INFILE='USERID1.IPA.SOURCE(CPPDLL)',
//      OUTFILE='USERID1.IPA.OBJECT(CPPDLL),DISP=SHR',
//      CPARAM='OPTFILE(DD:OPTIONS)'
//OPTIONS DD *
//      IPA(NOOBJECT) OPT(2)
//      LSEARCH('USERID1.IPA.+')
//      SEARCH('CEE.SCEEH.+')
/*
//*-----
//* IPA Compile Step for USERINT
//*-----
//C001F336 EXEC CBCC,
//      INFILE='USERID1.IPA.SOURCE(USERINT)',
//      OUTFILE='USERID1.IPA.OBJECT(USERINT),DISP=SHR',
//      CPARAM='OPTFILE(DD:OPTIONS)'
//OPTIONS DD *
//      IPA(NOOBJECT) OPT(2)
//      LSEARCH('USERID1.IPA.+')
//      SEARCH('CEE.SCEEH.+')
/*
//*-----
//* IPA Link Step for the hello module
//*-----
//C001F336 EXEC CBCI,
//      OUTFILE='USERID1.IPALINK.OBJECT(MYDLL),DISP=SHR',
//      IPARM='OPTFILE(DD:OPTIONS)'
//* The following line sets up an input file that just includes all
//* the IPA Compile Step object files.
//SYSIN DD DATA,DLM='>'
//      INCLUDE OBJECT(USERINT,CDLL,CPPDLL)
//      INCLUDE SYSLIB(C128,IOSTREAM,COMPLEX)
/>
//* These are the options used
```

```

//OPTIONS DD DATA,DLM='/>'
        IPA(LINK,LEVEL(1),CONTROL('USERID1.ipa.cntl(dllcx)'))
        OPT(2) RENT LONGNAME
/>
/* The following line gives the object library
//OBJECT DD DSN=USERID1.IPA.OBJECT,DISP=SHR

```

In the resultant object deck (MYDLL), only functions that are explicitly exported using **#pragma export** and the four functions given in the control file are exported.

---

## Using Profile-Directed Feedback (PDF)

In any large application, there are sections of code that are not often executed, such as code for error-handling. A traditional compiler cannot tell what these low frequency sections of code or functions are, and may spend a lot of time optimizing code that will never be executed. *Profile-Directed Feedback* (PDF) can be used to collect information about the way the program is really used and the compiler can use this information when optimizing the code. PDF also enables you to receive estimates on how many times loops are iterated.

### Steps for utilizing PDF optimization

Perform the following four steps to utilize the PDF optimization:

1. Compile some or all of the source files in a program with the IPA PDF1 suboption. The OPTIMIZE(2) option, or preferably the OPTIMIZE(3) option, as well as the IPA(LEVEL(1|2)) option should be specified for optimization. Special attention should be paid to the compiler options that are used to compile the files because the same options (other than IPA(PDF1)) must be used later.  
In a large application, the use of the PDF1 suboption should be concentrated on those areas of the code that can benefit most from optimization. You do not need to compile all of the code for your application with the PDF1 suboption, but you do need to compile the main function with the PDF1 suboption.

---

2. If you are using an MVS data set for your PDF file, preallocate the PDF data set using RECFM = U and LRECL = 0.
3. Run the program build from step 1 with typical input data. The program records profiling information when it finishes. The program can be run multiple times with different input data sets, and the profiling information is accumulated to provide a count of how often branches are taken and blocks of code are executed, based on the input data sets used. It is critically important that the data used is representative of the data that will be used during a normal run of the finished program.

---

4. Re-build your program using the identical set of source files with the identical compiler options that you used in step 1, but change the PDF1 suboption to PDF2. In this second stage, the accumulated profiling information is used to fine-tune the optimizations. The resulting program contains no profiling overhead.

---

Specifically, the following JCL can be used to perform a PDF1 compile of the hello world program that is shown above (see “Example 1. all C parts” on page 331).

```

//USERID1A JOB (127A,0329),'$MEM$',
// MSGLEVEL=(2,0),MSGCLASS=S,CLASS=A,
// NOTIFY=USERID1,REGION=1024M
//PROC JCLLIB ORDER=(CBC.SCCNPRC)
//*-----
//* IPA Compile Step for hello1.c
//*-----
//C001F336 EXEC EDCC,
//      INFILE='USERID1.IPA.SOURCE(HELLO1)',
//      OUTFILE='USERID1.IPA.OBJECT(HELLOX1),DISP=SHR',
//      CPARM='OPTFILE(DD:OPTIONS)'
//OPTIONS DD *
//      IPA(NOOBJECT,PDF1) RENT LONG OPT(2) XPLINK GOFF
/*
//*-----
//* IPA Compile Step for hello2.c
//*-----
//C001F336 EXEC EDCC,
//      INFILE='USERID1.IPA.SOURCE(HELLO2)',
//      OUTFILE='USERID1.IPA.OBJECT(HELLOX2),DISP=SHR',
//      CPARM='OPTFILE(DD:OPTIONS)'
//OPTIONS DD *
//      IPA(NOOBJECT,PDF1) RENT LONG OPT(2) XPLINK GOFF
/*
//*-----
//* IPA Compile Step for hello3.c
//*-----
//C001F336 EXEC EDCC,
//      INFILE='USERID1.IPA.SOURCE(HELLO3)',
//      OUTFILE='USERID1.IPA.OBJECT(HELLOX3),DISP=SHR',
//      CPARM='OPTFILE(DD:OPTIONS)'
//OPTIONS DD *
//      IPA(NOOBJECT,LIST,PDF1) RENT LONG OPT(2) XPLINK GOFF
/*
//*-----
//* IPA Link Step for the hello module
//*-----
//C001F336 EXEC EDCXI,
//      OUTFILE='USERID1.IPALINK.OBJECT(HELLOXP),DISP=SHR',
//      IPARM='OPTFILE(DD:OPTIONS)'
//* The following line sets up an input file that just includes all
//* the IPA Compile Step object files.
//SYSIN DD DATA,DLM='>'
//      INCLUDE OBJECT(HELLOX1,HELLOX2,HELLOX3)
//      INCLUDE SYSLIB(CELHS003,CELHS001)
/>
//* These are the options used
//OPTIONS DD DATA,DLM='>'
//      IPA(LINK,LEVEL(2),MAP,PDF1,PDFNAME(//'USERID1.MY.PDF'))
//      OPT(2) RENT LONGNAME LIST
//      XPLINK GOFF
/>
//* The following line gives the object library
//OBJECT DD DSN=USERID1.IPA.OBJECT,DISP=SHR
//*-----
//* LINK the hello module
//*-----
//C001F336 EXEC CCNXPDI,
//      INFILE='USERID1.IPALINK.OBJECT(HELLOXP)',
//      OUTFILE='USERID1.DEV.LOAD1(HELLOXP),DISP=SHR'

```

**Note:** The PDF1 option is specified on each of the IPA compiles, and the PDFNAME suboption is specified on the IPA Link step. This PDFNAME suboption gives the name of the file where the statistics about the program will be stored, this file is referred to as the *PDF file*. While it is not strictly required to preallocate the PDF file, when using a PS or PDS file, the data



set may be required to preallocate to ensure the file is large enough. If the PDF file is preallocated, it should be allocated with an LRECL of 0 and a RECFM of U.

Finally, instead of using a traditional link proc, the link of the PDF1 code should be done with the CCNPD1B proc (for non-XPLINK code), the CCNXP1B proc (for XPLINK code), or the CCNQPD1B proc for 64-bit code and linking. These procs provide all the libraries necessary to allow the object file created by the IPA Link step to be linked with the PDF run-time function that stores the statistical information.

A PDF2 IPA Compile job looks very similar to the above except the:

- PDF2 suboption is used in every place that PDF1 is used above
- Traditional EDCB proc can be used to bind the object created during the IPA Link step into a module

## Steps for building a module in UNIX System Services using PDF

Perform the following steps in UNIX System Services to build a module using the PDF process:

1. Build the PDF1 module using the following commands:

```
c89 -c -2 -WI,PDF1 hello1.c hello2.c hello3.c
c89 -2 -WI,PDF1 -WI,PDF1,PDFNAME\(/hello.pdf\) ,LEVEL\{2\} -o
hello hello1.o hello2.o hello3.o
```

If you are using the xlc utility, the command line syntax is:

```
c89 -c -02 -qipa=pdf1 hello1.c hello2.c hello3.c
c89 -02 -qipa=pdf1 -qipa=level=2 -qipa=pdfname=./hello.pdf -o
hello hello1.o hello2.o hello3.o
```

2. Run the module, to create hello.pdf:

```
hello
```

3. Rebuild the module using the information in hello.pdf using the following commands:

```
c89 -c -2 -WI,PDF2 hello1.c hello2.c hello3.c
c89 -2 -WI,PDF2,PDFNAME\(/hello.pdf\) ,LEVEL\{2\} -o hello hello1.o
hello2.o hello3.o
```

If you are using the xlc utility, the command line syntax is:

```
c89 -c -02 -qipa=pdf2 hello1.c hello2.c hello3.c
c89 -02 -qipa=pdf2 -qipa=level=2 -qipa=pdfname=./hello.pdf -o
hello hello1.o hello2.o hello3.o
```

---

## Reference Information

The following section provides reference information concerning the IPA Link step control file, and object file directives understood by IPA.

### IPA Link step control file

The IPA Link step control file is a fixed-length or variable-length format file that contains additional IPA processing directives. The CONTROL suboption of the IPA compiler option identifies this file.

The IPA Link step issues an error message if any of the following conditions exist in the control file:

- The control file directives have invalid syntax.
- There are no entries in the control file.
- Duplicate names exist in the control file.

You can specify the following directives in the control file.

**csect=csect\_names\_prefix**

Supplies information that the IPA Link step uses to name the CSECTs for each partition that it creates. The *csect\_names\_prefix* parameter is a comma-separated list of tokens that is used to construct CSECT names.

The behavior of the IPA Link steps varies depending upon whether you specify the CSECT option with a qualifier.

- If you do not specify the CSECT option with a qualifier, the IPA Link step does the following:
  - Truncates each name prefix or pads it at the end with @ symbols, if necessary, to create a 7 character token
  - Uppercases the token
  - Adds a suffix to specify the type of CSECT, as follows:

|          |             |
|----------|-------------|
| <b>C</b> | code        |
| <b>S</b> | static data |
| <b>T</b> | test        |

- If you specify the CSECT option with a non-null qualifier, the IPA Link step does the following:

- Uppercases the token
- Adds a suffix to specify the type of CSECT, as follows where *qualifier* is the qualifier you specified for CSECT and *nameprefix* is the name you specified in the IPA Link Step Control File:

|                               |             |
|-------------------------------|-------------|
| <i>qualifier#nameprefix#C</i> | code        |
| <i>qualifier#nameprefix#S</i> | static data |
| <i>qualifier#nameprefix#T</i> | test        |

- If you specify the CSECT option with a null qualifier, the IPA Link step does the following:

- Uppercases the token
- Adds a suffix to specify the type of CSECT, as follows where *nameprefix* is the name you specified in the IPA Link Step Control File:

|                     |             |
|---------------------|-------------|
| <i>nameprefix#C</i> | code        |
| <i>nameprefix#S</i> | static data |
| <i>nameprefix#T</i> | test        |

The IPA Link step issues an error message if you specify the CSECT option but no control file, or did not specify any *csect* directives in the control file. In this situation, IPA generates a CSECT name and an error message for each partition.

The IPA Link step issues a warning or error message (depending upon the presence of the CSECT option) if you specify CSECT name prefixes, but the number of entries in the *csect\_names* list is fewer than the number of partitions that IPA generated. In this

situation, for each unnamed partition, the IPA Link step generates a CSECT name prefix with format @CSnnnn, where nnnn is the partition number. If you specify the CSECT option, the IPA Link step also generates an error message for each unnamed partition. Otherwise, the IPA Link step generates a warning message for each unnamed partition.

**noexports** Removes the "export" flag from all symbols (functions and variables) in IPA and non-IPA input files.

**export=name[,name]**

Specifies a list of symbols (functions and variables) to export by setting the symbol "export" flag. Note: Only symbols defined within IPA objects can be exported using this directive.

**inline=name[,name]**

Specifies a list of functions that are desirable for the compiler to inline. The functions may or may not be inlined.

**inline=name[,name] from name[,name]**

Specifies a list of functions that are desirable for the compiler to inline, if the functions are called from a particular function or list of functions. The functions may or may not be inlined.

**noinline=name[,name]**

Specifies a list of functions that the compiler will not inline.

**noinline=name[,name] from name[,name]**

Specifies a list of functions that the compiler will not inline, if the functions are called from a particular function or list of functions.

**exits=name[,name]**

Specifies names of functions that represent program exits. Program exits are calls that can never return, and can never call any procedure that was compiled with the IPA Compile step.

**lowfreq=name[,name]**

Specifies names of functions that are expected to be called infrequently. These functions are typically error handling or trace functions.

**partition=small|medium|large|unsigned-integer**

Specifies the size of each program partition that the IPA Link step creates. When partition sizes are large, it usually takes longer to complete the code generation, but the quality of the generated code is usually better.

For a finer degree of control, you can use an *unsigned-integer* value to specify the partition size. The integer is in ACUs (Abstract Code Units), and its meaning may change between releases. You should only use this integer for very short term tuning efforts, or when the number of partitions (and therefore the number of CSECTs in the output object module) must remain constant.

The size of a CSECT cannot exceed 16 MB with the XOBJ format. Large CSECTs require the GOFF option.

The default for this directive is *medium*.

**partitionlist=partition\_number[,partition\_number]**

Used to reduce the size of an IPA Link listing. If the IPA Link control

file contains this directive and the LIST option is active, a pseudo-assembly listing is generated for only these partitions.

*partition\_number* is a decimal number representing an unsigned int.

**safe=name[,name]**

Specifies a list of *safe functions* that are not compiled as IPA objects. These are functions that do not call a visible (not missing) function either through a direct call or a function pointer. Safe functions can modify global variables, but may not call functions that are not compiled as IPA objects.

**isolated=name[,name]**

Specifies a list of *isolated functions* that are not compiled as IPA objects. Neither isolated functions nor functions within their call chain can refer to global variables. IPA assumes that functions that are bound from shared libraries are isolated.

**pure=name[,name]**

Specifies a list of *pure functions* that are not compiled as IPA objects. These are functions that are safe and isolated and do not indirectly alter storage accessible to visible functions. A pure function has no observable internal state nor has side-effects, defined as potentially altering any data visible to the caller. This means that the returned value for a given invocation of a function is independent of any previous or future invocation of the function.

**unknown=name[,name]**

Specifies a list of *unknown functions* that are not compiled as IPA objects. These are functions that are not safe, isolated, or pure. This is the default for all functions defined within non-IPA objects. Any function specified as unknown can make calls to other parts of the program compiled as IPA objects and modify global variables and dummy arguments. This option greatly restricts the amount of interprocedural optimization for calls to unknown functions.

**missing=attribute**

Specifies the characteristics of *missing functions*. There are two types of missing functions:

- Functions dynamically linked from another DLL (defined using an IPA Link IMPORT control statement)
- Functions that are statically available but not compiled with the IPA option

IPA has no visibility to the code within these functions. You must ensure that all user references are resolved at IPA Link time with user libraries or run-time libraries.

The default setting for this directive is unknown. This instructs IPA to make pessimistic assumptions about the data that may be used and modified through a call to such a missing function, and about the functions that may be called indirectly through it.

You can specify the following attributes for this directive:

**safe** Specifies that the missing functions are safe. See the description for the safe directive, above.

- isolated** Specifies that the missing functions are isolated. See the description for the `isolated` directive, above.
- pure** Specifies that the missing functions are pure. See the description for the `pure` directive, above.
- unknown** Specifies that the missing functions are unknown. See the description for the `unknown` directive, above. This is the default attribute.

**retain=***symbol-list*

Specifies a list of exported functions or variables that the IPA Link step retains in the final object module. The IPA Link step does not prune these functions or variables during optimization.

**Note:** In the listed directives, *name* can be a regular expression. Thus, *name* can match multiple symbols in your application through pattern matching. The regular expression syntax supported by the IPA control file processor is as follows:

Table 37. Syntax rules for specifying regular expressions

| Expression                                   | Description  |
|--|--|
| <i>string</i>                                | Matches any of the characters specified in <i>string</i> . For example, <code>test</code> will match <code>testimony</code> , <code>latest</code> , and <code>intestine</code> .   |
| <code>^string</code>                         | Matches the pattern specified by <i>string</i> only if it occurs at the beginning of a line.   |
| <i>string</i> <code>\$</code>                | Matches the pattern specified by <i>string</i> only if it occurs at the end of a line.   |
| <i>str.ing</i>                               | The period ( <code>.</code> ) matches any single character. For example, <code>t.st</code> will match <code>test</code> , <code>tast</code> , <code>tZst</code> , and <code>t1st</code> .  |
| <i>string</i> <code>\special_char</code>     | The backslash ( <code>\</code> ) can be used to escape special characters. For example, assume that you want to find lines ending with a period. Simply specifying the expression <code>.\$</code> would show all lines that had at least one character of any kind in it. Specifying <code>\.\$</code> escapes the period ( <code>.</code> ), and treats it as an ordinary character for matching purposes. |
| <code>[string]</code>                        | Matches any of the characters specified in <i>string</i> . For example, <code>t[a-g123]st</code> matches <code>tast</code> and <code>test</code> , but not <code>t-st</code> or <code>tAst</code> .  |
| <code>[^string]</code>                       | Does not match any of the characters specified in <i>string</i> . For example, <code>t[^a-zA-Z]st</code> matches <code>t1st</code> , <code>t-st</code> , and <code>t,st</code> but not <code>test</code> or <code>tYst</code> .  |
| <i>string</i> <code>*</code>                 | Matches zero or more occurrences of the pattern specified by <i>string</i> . For example, <code>te*st</code> will match <code>tst</code> , <code>test</code> , and <code>teeeest</code> .  |
| <i>string</i> <code>+</code>                 | Matches one or more occurrences of the pattern specified by <i>string</i> . For example, <code>t(es)+t</code> matches <code>test</code> , <code>tesest</code> , but not <code>tt</code> .  |
| <i>string</i> <code>?</code>                 | Matches zero or one occurrences of the pattern specified by <i>string</i> . For example, <code>te?st</code> matches either <code>tst</code> or <code>test</code> .   |
| <i>string</i> <code>{m,n}</code>             | Matches between <i>m</i> and <i>n</i> occurrence(s) of the pattern specified by <i>string</i> . For example, <code>a{2}</code> matches <code>aa</code> , and <code>b{1,4}</code> matches <code>b</code> , <code>bb</code> , <code>bbb</code> , and <code>bbbb</code> .   |
| <i>string1</i> <code> </code> <i>string2</i> | Matches the pattern specified by either <i>string1</i> or <i>string2</i> . For example, <code>s   o</code> matches both characters <code>s</code> and <code>o</code> .   |

## Object file directives understood by IPA

IPA recognizes and acts on the following binder object control directives:

- INCLUDE
- LIBRARY
- IMPORT

Some other linkage control statements (such as NAME, RENAME and ALIAS) are accepted and passed through to the linker.

---

## Troubleshooting

It is strongly recommended that you resolve all warnings that occur during the IPA Link step. Resolution of these warnings often removes seemingly unrelated problems.

The following list provides frequently asked questions (Q) and their respective answers (A):

- Q - I am running out of memory while using IPA. Are there any options for reducing its use of memory and increasing the system-defined limits?  
A - IPA reacts to the NOMEMORY option, and the code generator will react to the MAXMEM option. If this does not give you sufficient memory, consider running IPA from batch where more memory can be accessed. Before switching to batch, verify with your system programmer that you have access to the maximum possible memory (both in batch and in UNIX System Services). See "Steps for diagnosing errors that occur at IPA Link time" on page 599 for more information on setting the MEMLIMIT and the REGION system parameters. You could also reduce the level of IPA processing via the IPA LEVEL suboption.
- Q - I am receiving a "partition too large" warning. How do I fix it?  
A - Use the IPA Control file to specify a different partition size.
- Q - My IPA Compile time is too long. Are there any options?  
A - Using a lower IPA compilation level (0 or 1 instead of 2) will reduce the compile time. To minimize the compile time, ensure you are using the IPA(NOOBJECT) option for your IPA compiles. A smaller partition size, specified in the control file, may minimize the amount of time spent in the code generator. Limiting inlining, may improve your compile time, but it will decrease your performance gain significantly and should only be done selectively using the IPA control file. Use the IPA control file to specify little used functions as low frequency so that IPA does not spend too much time trying to optimize them.
- Q - Can I tune the IPA automatic inlining like I can for the regular inliner?  
A - Yes. Use the INLINE option for the IPA Link step.
- Q - I am using IPA(PDF1) and my program will not bind. What do I do?  
A - Under UNIX System Services, specify **-WI,PDF1** when linking with c89 or C++. Under MVS batch, use the CCNPD1B, CCNXP1B, or CCNQPD1B PROCs. For further information on these PROCs, see Chapter 12, "Cataloged procedures and REXX EXECs," on page 419.

---

## Chapter 9. Binding z/OS XL C/C++ programs

This chapter describes how to bind your programs using the program management binder in the z/OS batch, z/OS UNIX System Services, and TSO environments.

---

### When you can use the binder

The output of the binder is a program object. You can store program objects in a PDSE member or in a z/OS UNIX System Services file. Depending on the environment you use, you can produce binder program objects as follows:

- For c89:
  - If the targets of your executables are z/OS UNIX files, you can use the binder. If the targets of your executables are PDSs, you must use the prelinker, followed by the binder. If the targets of your executables are PDSEs, you can use the binder alone.
- For z/OS batch or TSO:
  - If you can use PDSEs, you can use the binder. If you want to use PDSs, you must use the prelinker for the following:
    - C++ code
    - C code compiled with the LONGNAME, RENT, or DLL options
- For GOFF and XPLINK:
  - If you have compiled your program with the GOFF, XPLINK, or LP64 compiler options, you must use the binder.

For more information on the prelinker, see Appendix A, “Prelinking and linking z/OS XL C/C++ programs,” on page 549.

---

### When you cannot use the binder

The following restrictions apply when you are using the binder to produce a program object.

#### Your output is a PDS, not a PDSE

If you are using z/OS batch or TSO, and your output must target a PDS instead of a PDSE, you cannot use the binder.

#### CICS

Prior to CICS Transaction Server for z/OS V3R1, PDSEs are not supported. From CICS Transaction Server for z/OS V3R1 onwards, there is support in CICS for PDSEs. Please refer to *CICS Transaction Server for z/OS Release Guide*, where there are several references to PDSEs, and a list of prerequisite APAR fixes.

#### MTF

MTF does not support PDSEs. If you have to target MTF, you cannot use the binder.

#### IPA

Object files that are generated by the IPA Compile step using the IPA(NOLINK,OBJECT) compiler option may be given as input to the binder. Such an object file is a combination of an IPA object module, and a regular compiler

object module. The binder processes the regular compiler object module, ignores the IPA object module, and no IPA optimization is done.

Object files that are generated by the IPA Compile step using the IPA(NOLINK,NOOBJECT) compiler option should not be given as input to the binder. These are IPA-only object files, and do not contain a regular compiler object module.

The IPA Link step will not accept a program object as input. IPA Link can process load module (PDS) input files, but not program object (PDSE) input files.

---

## Using different methods to bind

This section shows you how to use the following different methods to bind your application:

### **Single final bind**

Compile all your code and then perform a single final bind of all the object modules.

### **Bind each compile unit**

Compile and bind each compilation unit, then perform a final bind of all the partially bound program objects.

### **Build and use a DLL**

Build DLLs and programs that use those DLLs.

### **Rebind a changed compile unit**

Recompile only changed compile units, and rebind them into a program object without needing other unchanged compile units.

## Single final bind

You can use the method that is shown in Figure 30 on page 357 to build your application executable for the first time. With this method, you compile each source code unit separately, then bind all of the resultant object modules together to produce an executable program object.



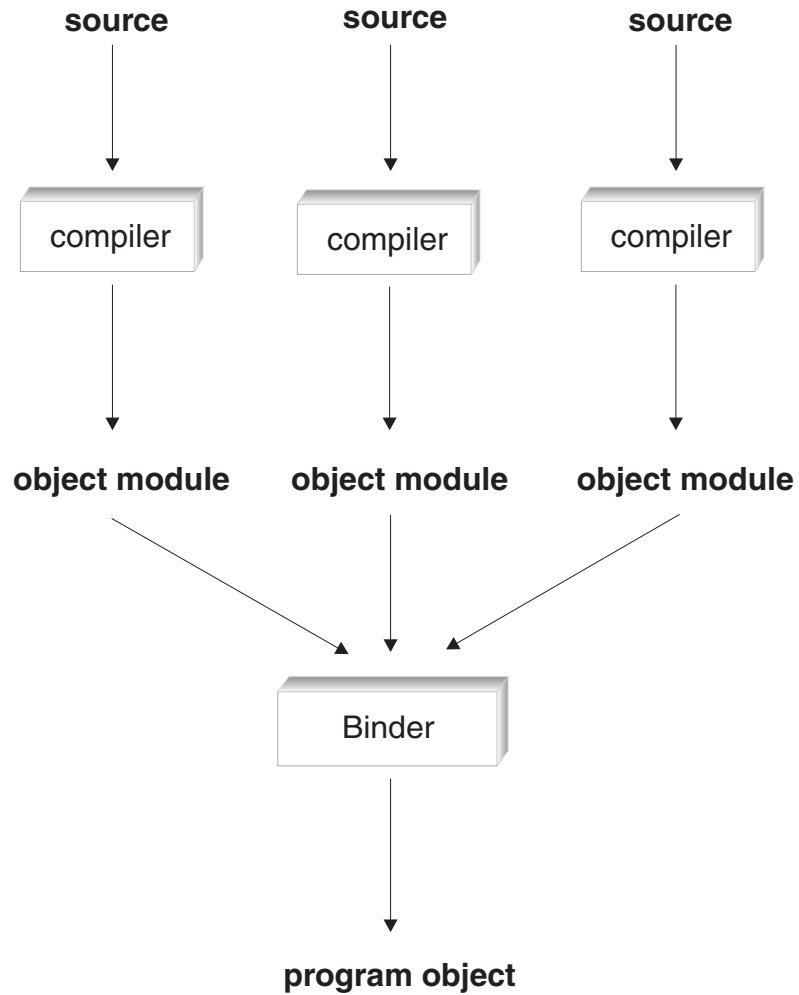

Figure 30. Single final bind

## Bind each compile unit

If you have changed the source in a compile unit, you can use the method that is shown in Figure 31 on page 358. With this method, you compile and bind your changed compile unit into an intermediate program object, which may have unresolved references. Then you bind all your program objects together to produce a single executable program object.

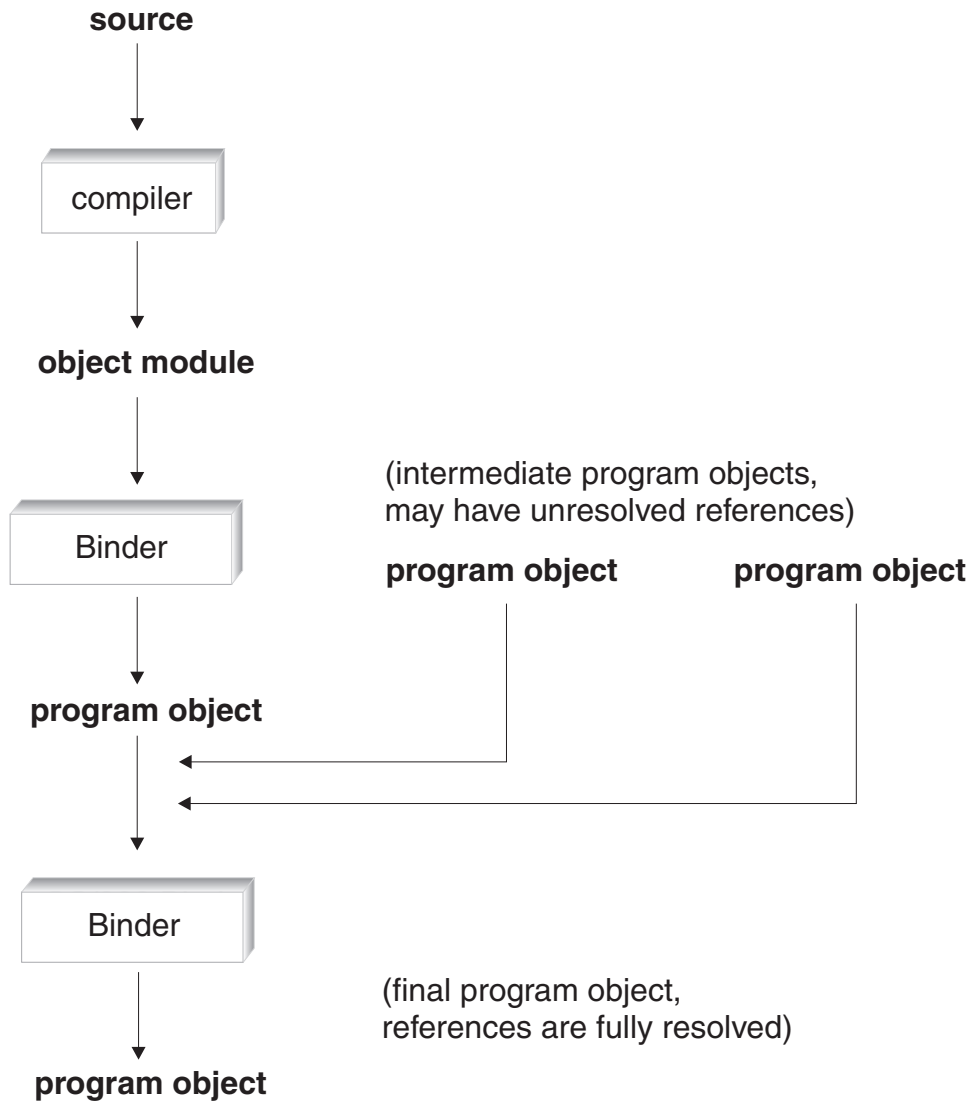

Figure 31. Bind each compile unit

## Build and use a DLL

You can use the method that is shown in Figure 32 on page 359 to build a DLL. To build a DLL, the code that you compile must contain symbols which indicate that they are exported. You can use the compiler option `EXPORTALL` or the `#pragma export` directive to indicate symbols in your C or C++ code that are to be exported. For C++, you can also use the `_Export` keyword.

When you build the DLL, the bind step generates a DLL and a file of `IMPORT` control statements which lists the exported symbols. This file is known as a definition side-deck. The binder writes one `IMPORT` control statement for each exported symbol. The file that contains `IMPORT` control statements indicates symbol names which may be imported and the name of the DLL from which they are imported.

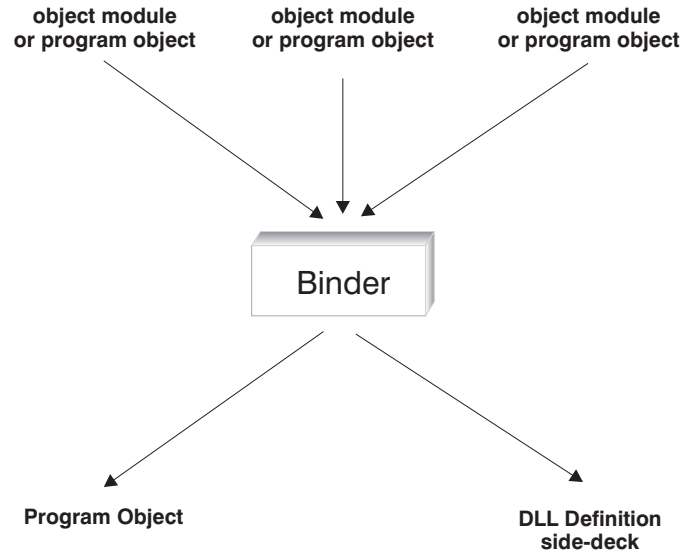

Figure 32. Build a DLL

You can use the method that is shown in Figure 33 to build an application that uses a DLL. To build a program which dynamically links symbols from a DLL during application run time, you must have C++ code, or C code that is compiled with the DLL option. This allows you to import symbols from a DLL. You must have an IMPORT control statement for each symbol that is to be imported from a DLL. The IMPORT control statement controls which DLL will be used to resolve an imported function or variable reference during execution. The bind step of the program that imports symbols from the DLL must include the definition side-deck of IMPORT control statements that the DLLs build generated.

The binder does not take an incremental approach to the resolution of DLL-linkage symbols. When binding or rebinding a program that uses a DLL, you must always specify the DYNAM(DLL) option, and must provide all IMPORT control statements. The binder does not retain these control statements for subsequent binds.

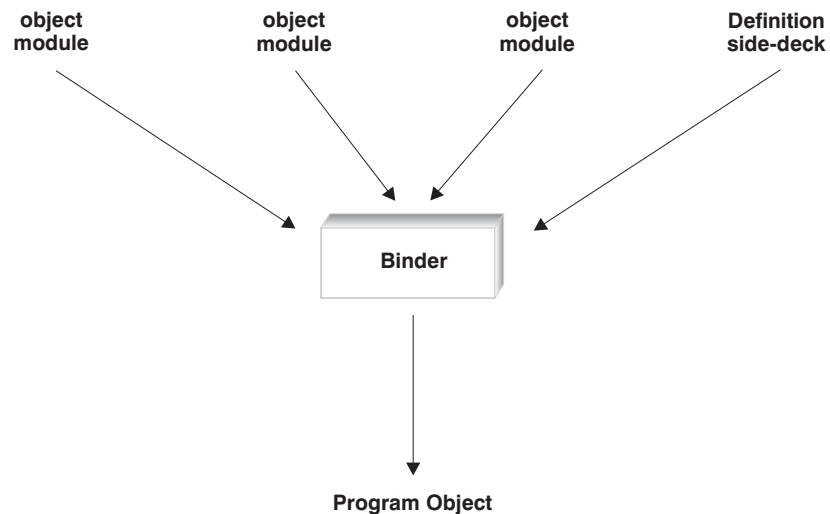

Figure 33. Build an application that uses a DLL

## Rebind a changed compile unit

You can use the method shown in Figure 34 to rebind an application after making changes to a single compile unit. Compile your changed source file and then rebind the resultant object module with the complete program object of your application. This will replace the binder sections that are associated with the changed compile unit in the program.

You can use this method to maintain your application. For example, you can change a source file and produce a corresponding object module. You can then ship the object module to your customer, who can bind the new object module with the complete program object for the application. If you use this method, you have fewer files to maintain: just the program object for the application and your source code.

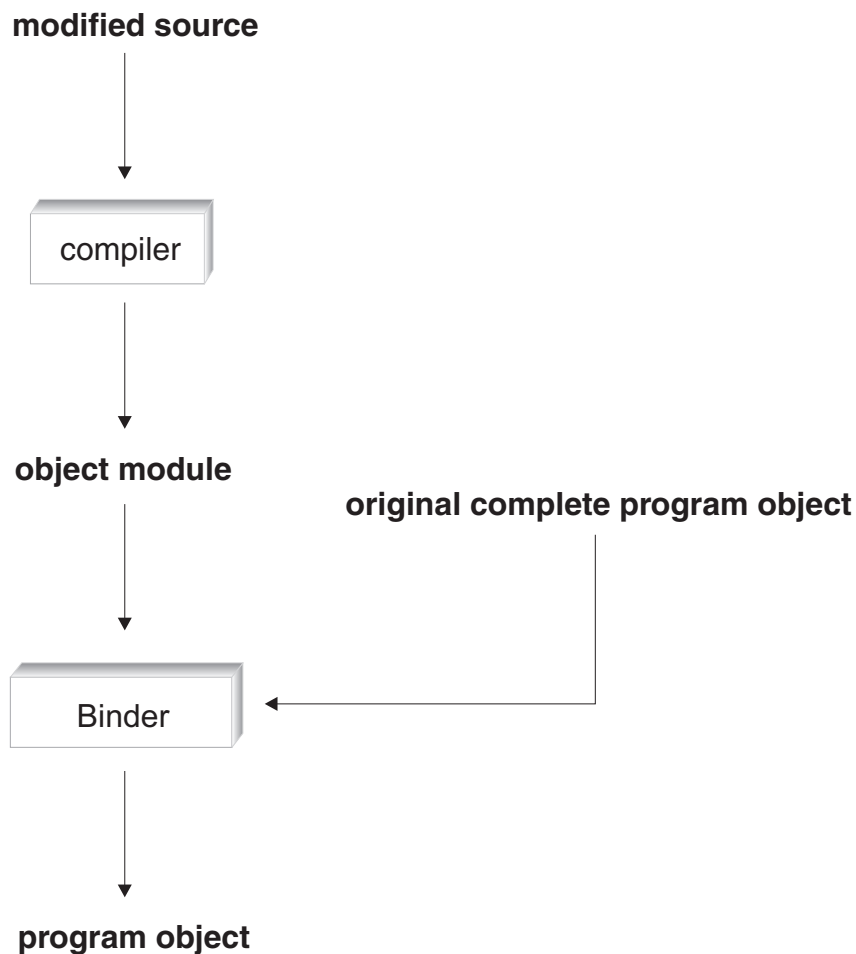

Figure 34. Rebinding a changed compile unit

---

## Binding under z/OS UNIX System Services

The `c89` and `xlC` utilities are the interface to the compiler and the binder for z/OS UNIX System Services C/C++ applications. You can use all supported command names, for example, `c89`, `c++`, and `xlC`, to compile, to compile and bind a program in one step, or to bind application object modules after compilation.

The default, for the above utilities, is to invoke the binder alone, without first invoking the prelinker. That is, since the OS/390 V2R4 level of OS/390 Language

Environment and DFSMS 1.4, if the output file (-o executable) is not a PDS member, then the binder will be invoked. To modify your environment to run the prelinker, refer to the description of the *prefix\_STEPS* environment variable in “Environment variables” on page 504.

Typically, you invoke the c89 and c++ utilities from the z/OS shell. For more information on these utilities, see Chapter 20, “c89 — Compiler invocation using host environment variables,” on page 489 or the *z/OS UNIX System Services Command Reference*.

To bind your XPLINK module, specify **-WI,xplink** on the c89/c++ command.

## z/OS UNIX System Services example

The example source files `unit0.c`, `unit1.c`, and `unit2.c` that are shown in Figure 35, are used to illustrate all of the z/OS UNIX System Services examples that follow.

```
/* file: unit0.c */
#include <stdio.h>
extern int f1(void);
extern int f4(void);
int main(void) {
    int rc1;
    int rc4;
    rc1 = f1();
    rc4 = f4();
    if (rc1 != 1) printf("fail rc1 is %d\n",rc1);
    if (rc4 != 40) printf("fail rc4 is %d\n",rc4);
    return 0;
}

/* file: unit1.c */
int f1(void) { return 1; }

/* file: unit2.c */
int f2(void) { return 20;}
int f3(void) { return 30;}
int f4(void) { return f2()*2; /* 40 */ }
```

Figure 35. Example source files

## Steps for single final bind using c89

**Before you begin:** Compile each source file and then perform a single final bind.

Perform the following steps to perform a single final bind using **c89**:

1. Compile each source file to generate the object modules `unit0.o`, `unit1.o`, and `unit2.o` as follows:

```
c89 -c -W c,"CSECT(myprog)" unit0.c
c89 -c -W c,"CSECT(myprog)" unit1.c
c89 -c -W c,"CSECT(myprog)" unit2.c
```

2. Perform a final single bind to produce the executable program `myprog`. Use the `c89` utility as follows:

```
c89 -o myprog unit0.o unit1.o unit2.o
```

The **-o** option of the **c89** command specifies the name of the output executable. The **c89** utility recognizes from the file extension **.o** that **unit0.o**, **unit1.o** and **unit2.o** are not to be compiled but are to be included in the bind step.

---

**Example:** The following is an example of a makefile to perform a similar build:

```
PGM = myprog
SRCS = unit0.c unit1.c unit2.c
OBSJ = $(SRCS:b:+".o")
COPTS = -W c,"CSECT(myprog)"
$(PGM) : $(OBSJ)
        c89 -o $(PGM) $(OBSJ)
%.o : %.c
        c89 -c -o $@ $(COPTS) $<
```

For more information on makefiles, see *z/OS UNIX System Services Programming Tools*.

### Advantage

This method is simple, and is consistent with existing methods of building applications, such as makefiles.

## Steps for binding each compile unit using **c89**

**Before you begin:** Compile each source file and also bind it.

Perform the following steps to complete a final bind of all the partially bound units:

1. Compile each source file to its object module (**.tmp**). Bind each object module into a partially bound program object (**.o**), which may have unresolved references. In this example, references to **f1()** and **f4()** in **unit0.o** are unresolved. When the partially bound programs are created, remove the object modules as they are no longer needed. Use **c89** to compile each source file, as follows:

```
c89 -c -W c,"CSECT(myprog)" -o unit0.tmp unit0.c
c89 -r -o unit0.o unit0.tmp
rm unit0.tmp
```

```
c89 -c -W c,"CSECT(myprog)" -o unit1.tmp unit1.c
c89 -r -o unit1.o unit1.tmp
rm unit1.tmp
```

```
c89 -c -W c,"CSECT(myprog)" -o unit2.tmp unit2.c
c89 -r -o unit2.o unit2.tmp
rm unit2.tmp
```

The **-r** option supports rebindability by disabling autocall processing.

---

2. Perform the final single bind to produce the executable program **myprog** by using **c89**:

```
c89 -o myprog unit0.o unit1.o unit2.o
```

---

**Example:** The following is an example of a makefile for performing a similar build:

```

_C89_EXTRA_ARGS=1
_EXPORT : _C89_EXTRA_ARGS      1
PGM = myprog                    2
SRCS = unit0.c unit1.c unit2.c  3
OBJS = $(SRCS:b:+".o")         4
COPTS = -W c,"CSECT(myprog)"
$(PGM) : $(OBJS)               5
    c89 -o $(PGM) $(OBJS)
%.tmp : %.c                    6
    c89 -c -o $$ $(COPTS) $<
%.o : %.tmp                    7
    c89 -r -o $$ $<

```

- 1 Export the environment variable `_C89_EXTRA_ARGS` so `c89` will process files with non-standard extensions. Otherwise `c89` will not recognize `unit0.tmp`, and the makefile will fail
- 2 name of executable
- 3 list of source files
- 4 list of partly bound parts
- 5 executable depends on parts
- 6 make `.tmp` file from `.c`
- 7 make `.o` from `.tmp`

In this example, **make** automatically removes the intermediate `.tmp` files after the makefile completes, since they are not marked as `PRECIOUS`. For more information on makefiles, see *z/OS UNIX System Services Programming Tools*.

### Advantage

Binding a set of partially bound program objects into a fully bound program object is faster than binding object modules into a fully bound program object for `NOGOFF` objects. For example, a central build group can create the partially bound program objects. Developers can then use these program objects and their changed object modules to create a development program object.

## Steps for building and using a DLL using `c89`

**Before you begin:** Build `unit1.c` and `unit2.c` into DLL `onetwo`, which exports functions `f1()`, `f2()`, `f3()`, and `f4()`. Then build `unit0.c` into a program which dynamically links to functions `f1()` and `f4()` defined in the DLL.

Perform the following steps to build and use a DLL using **c89**:

1. Compile `unit1.c` and `unit2.c` to generate the object modules `unit1.o` and `unit2.o` which have functions to be exported. Use the `c89` utility as follows:

```

c89 -c -W c,"EXPORTALL,CSECT(myprog)" unit1.c
c89 -c -W c,"EXPORTALL,CSECT(myprog)" unit2.c

```

2. Bind `unit1.o` and `unit2.o` to generate the DLL `onetwo`:

```

c89 -Wl,dll -o onetwo unit1.o unit2.o

```

When you bind code with exported symbols, you should specify the DLL binder option (**-W l,dll**).

In addition to the DLL `onetwo` being generated, the binder writes a list of `IMPORT` control statements to `onetwo.x`. This list is known as the definition side-deck. One `IMPORT` control statement is written for each exported symbol.

These generated control statements will be included later as input to the bind step of an application that uses this DLL, so that it can import the symbols.

3. Compile `unit0.c` with the DLL option `-W c,DLL`, so that it can import unresolved symbols. Bind the object module, with the definition side-deck `onetwo.x` from the DLL build:

```
c89 -c -W c,DLL unit0.c
c89 -o dll12usr unit0.o onetwo.x
```

### Advantage

The bind-time advantage of using DLLs is that you only need to rebuild the DLL with the changed code in it. You do not need to rebuild all applications that use the DLL in order to use the changed code.

## Steps for rebinding a changed compile unit using `c89`

**Before you begin:** Rebuild an application after making a change to a single source file.

Perform the following steps to rebind a changed compile unit using `c89`:

1. Recompile the single changed source file. Use the compile time option `CSECT` to ensure that each section is named for purposes of rebinding. For example, assume that you have made a change to `unit1.c`. Recompile `unit1.c` by using `c89` as follows:

```
c89 -o unit1.o -W c,"CSECT(myprog)" unit1.c
```

2. Rebind only the changed compile unit into the executable program, which replaces its corresponding binder sections in the program object:

```
cp -m myprog myprog.old
c89 -o myprog unit1.o myprog
```

The `cp` command is optional. It saves a copy of the old executable in case the bind fails in such a way as to damage the executable. `myprog` is overwritten with the result of the bind of `unit1.o`. Like-named sections in `unit1.o` replace those in the `myprog` executable.

The following is an example of a makefile that performs a similar build:

```
_C89_EXTRA_ARGS=1
_EXPORT : _C89_EXTRA_ARGS 1
SRCS = unit0.c unit1.c unit2.c 2
myprog.PRECIOUS : $(SRCS) 3
@if [ -e $@ ]; then OLD=$@; else OLD=; fi;\
CMD="$(CC) -Wc,csect $(CFLAGS) $(LDFLAGS) -o $@ $? $$OLD";\ 4

echo $$CMD; $$CMD;
-@rm -f $(?:b+"$@")
```

- 1** allow filenames with non-standard suffixes
- 2** list of source files
- 3** do not delete `myprog` if the make fails
- 4** compile source files newer than the executable, and bind



The attribute `.PRECIOUS` ensures that such parts are not deleted if make fails.  `$?`  are the dependencies which are newer than the target.

**Note:**

- You need the `.PRECIOUS` attribute to avoid removing the current executable, since you depend on it as subsequent input.
- If more than one source part changes, and any compiles fail, then on subsequent makes, all compiles are redone.

For a complete description of all **c89** options see Chapter 20, “c89 — Compiler invocation using host environment variables,” on page 489. For a description of **make**, see *z/OS UNIX System Services Command Reference* and for a **make** tutorial, see *z/OS UNIX System Services Programming Tools*.

**Advantage**

Rebinds are fast because most of the program is already bound. Also, none of the intermediate object modules need to be retained because they are available from the program itself.

## Using the non-XPLINK version of the Standard C++ Library and c89

A non-XPLINK Standard C++ Library DLL is available that provides Standard C++ Library support for CICS and IMS. The CICS and IMS subsystems do not support XPLINK linkage, rendering the XPLINK Standard C++ Library DLL supplied with the compiler inoperable under both subsystems. The non-XPLINK Standard C++ Library DLL allows support for the Standard C++ Library in the CICS and IMS subsystems, as of z/OS V1R2. Since CICS and IMS do not support XPLINK linkage, a non-XPLINK DLL enables the Standard C++ Library under these subsystems.

To use the non-XPLINK Standard C++ Library DLL, you must first link your object modules with the non-XPLINK system definition side-deck. Use the `_CXX_PSYSIX` environment variable to pass the non-XPLINK side deck information to `c++/cxx`. The `_CXX_PSYSIX` environment variable specifies the system definition side-deck list to be used to resolve symbols during the non-XPLINK link-editing phase. The following concatenation should be used:

```
export _CXX_PSYSIX=\
"_CXX_PLIB_PREFIX.SCEELIB(C128N)":\
"_CXX_CLIB_PREFIX.SCLBSID(IOSTREAM,COMPLEX)"
```

where `_CXX_PLIB_PREFIX` and `_CXX_CLIB_PREFIX` are set to a default (for example, CEE and CBC, respectively) during custom installation, or using user overrides.

It is only necessary to specify `_CXX_PSYSIX` in order to use the non-XPLINK side deck with IPA. Corresponding non-XPLINK IPA link step environment variables default to the value of `_CXX_PSYSIX`. To run a program with the non-XPLINK DLL, ensure that the SCEERUN data set containing the non-XPLINK DLL is in the MVS search path; that is, either specified in your STEPLIB or already loaded into LPA.

**Performance**

Due to performance differences between XPLINK and non-XPLINK linkages, it is expected that an XPLINK program using the XPLINK Standard C++ Library DLL will outperform a non-XPLINK program using the non-XPLINK Standard C++ Library DLL.

It is possible to use the non-XPLINK DLL with an XPLINK application, although this is not preferred. A call to a function of different linkage than the callee will result in a performance degradation due to the overhead cost required to swap from one stack type to the other.

## Using the non-XPLINK version of the Standard C++ Library and xlc

To use the non-XPLINK Standard C++ Library DLL with **xlc**, the `exportlist` attribute in the configuration file must include the `c128n` (instead of `c128`) member of the CEE.SCEELIB data set.

### Performance

Due to performance differences between XPLINK and non-XPLINK linkages, it is expected that an XPLINK program using the XPLINK Standard C++ Library DLL will outperform a non-XPLINK program using the non-XPLINK Standard C++ Library DLL.

It is possible to use the non-XPLINK DLL with an XPLINK application, although this is not preferred. A call to a function of different linkage than the callee will result in a performance degradation due to the overhead cost required to swap from one stack type to the other.

---

## Binding under z/OS batch

You can use the following procedures, which the z/OS XL C/C++ compiler supplies, to invoke the binder:

| Procedure name | Description  |
|----------------|--|
| CEEXL          | C bind an XPLINK 32-bit program  |
| CEEXLR         | C bind and run an XPLINK 32-bit program                                    |
| EDCCB          | C compile and bind a non-XPLINK 32-bit program                             |
| EDCCBG         | C compile, bind, and run a non-XPLINK 32-bit program                       |
| EDCXCB         | C compile and bind an XPLINK 32-bit program                                |
| EDCXCBG        | C compile, bind, and run an XPLINK 32-bit program                          |
| EDCXLDEF       | Create C Source from a locale, compile, and bind the XPLINK 32-bit program |
| CBCB           | C++ bind a non-XPLINK 32-bit program                                       |
| CBCBG          | C++ bind and run a non-XPLINK 32-bit program                               |
| CBCCB          | C++ compile and bind a non-XPLINK 32-bit program                           |
| CBCCBG         | C++ compile, bind, and run a non-XPLINK 32-bit program                     |
| CBCXB          | C++ bind an XPLINK 32-bit program  |
| CBCXBG         | C++ bind and run an XPLINK 32-bit program                                  |
| CBCXCB         | C++ compile and bind an XPLINK 32-bit program                              |
| CBCXCBG        | C++ compile, bind, and run an XPLINK 32-bit program                        |
| CCNPD1B        | C or C++ bind an object compiled using the IPA(PDF1) and NOXPLINK options  |
| CCNXPD1B       | C or C++ bind an object compiled using the IPA(PDF1) and XPLINK options    |
| EDCQB          | C bind a 64-bit program  |
| EDCQBG         | C bind and run a 64-bit program  |
| EDCQCB         | C compile and bind a 64-bit program  |
| EDCQCBG        | C compile, bind, and run a 64-bit program                                  |
| CBCQB          | C++ bind a 64-bit program  |
| CBCQBG         | C++ bind and run a 64-bit program  |
| CBCQCB         | C++ compile and bind a 64-bit program                                      |
| CBCQCBG        | C++ compile, bind, and run a 64-bit program                                |

| Procedure name | Description   |
|----------------|---|
| CCNQPD1B       | C or C++ bind a 64-bit object compiled using the IPA(PDF1) and LP64 options |
| CBCLG          | Prelink, link, and run a 31-bit non-XPLINK program                          |

If you want to generate DLL code, you must use the binder DYNAM(DLL) option. All the z/OS XL C/C++ supplied cataloged procedures that invoke the binder use the DYNAM(DLL) option. For C++, these cataloged procedures use the DLL versions of the IBM-supplied class libraries by default; the IBM-supplied definition side-deck data set for class libraries, SCLBSID, is included in the SYSLIN concatenation.

## z/OS batch example

Figure 36 shows the example source files USERID.PLAN9.C(UNIT0), USERID.PLAN9.C(UNIT1), and USERID.PLAN9.C(UNIT2), which are used to illustrate all of the z/OS batch examples that follow.

```

/* file: USERID.PLAN9.C(UNIT0) */
#include <stdio.h>
extern int f1(void);
extern int f4(void);
int main(void) {
int rc1;
int rc4;
rc1 = f1();
rc4 = f4();
if (rc1 != 1) printf("fail rc1 is %d\n",rc1);
if (rc4 != 40) printf("fail rc4 is %d\n",rc4);
return 0;
}

/* file: USERID.PLAN9.C(UNIT1) */
int f1(void) { return 1; }

/* file: USERID.PLAN9.C(UNIT2) */
int f2(void) { return 20;}
int f3(void) { return 30;}
int f4(void) { return f2()*2; /* 40 */ }

```

Figure 36. Example source files

## Steps for single final bind under z/OS batch

**Before you begin:** Compile each source file.

Perform the following steps to complete a final single bind of everything:

1. Compile each source file to generate the object modules USERID.PLAN9.OBJ(UNIT0), USERID.PLAN9.OBJ(UNIT1), and USERID.PLAN9.OBJ(UNIT2). Use the EDCC procedure as follows:

```

//COMP0 EXEC EDCC,
//      INFILE='USERID.PLAN9.C(UNIT0)',
//      OUTFILE='USERID.PLAN9.OBJ,DISP=SHR',
//      CPARAM='LONG,RENT'
//COMP1 EXEC EDCC,
//      INFILE='USERID.PLAN9.C(UNIT1)',
//      OUTFILE='USERID.PLAN9.OBJ,DISP=SHR',
//      CPARAM='LONG,RENT'
//COMP2 EXEC EDCC,
//      INFILE='USERID.PLAN9.C(UNIT2)',
//      OUTFILE='USERID.PLAN9.OBJ,DISP=SHR',
//      CPARAM='LONG,RENT'

```

- 
2. Perform a final single bind to produce the executable program USERID.PLAN9.LOADE(MYPROG). Use the CBCB procedure as follows:

```

//BIND EXEC CBCB,OUTFILE='USERID.PLAN9.LOADE,DISP=SHR'
//OBJECT DD DSN=USERID.PLAN9.OBJ,DISP=SHR
//SYSIN DD *
INCLUDE OBJECT(UNIT0)
INCLUDE OBJECT(UNIT1)
INCLUDE OBJECT(UNIT2)
NAME MYPROG(R)
/*

```

The OUTFILE parameter along with the NAME control statement specify the name of the output executable to be created.

---

### Advantage

This method is simple, and is consistent with existing methods of building applications, such as makefiles.

## Steps for binding each compile unit under z/OS batch

**Before you begin:** Compile each source file and also bind it.

Perform the following steps to complete a final bind of all the partially bound units:

1. Compile and bind each source file to generate the partially bound program objects USERID.PLAN9.LOADE(UNIT0), USERID.PLAN9.LOADE(UNIT1), and USERID.PLAN9.LOADE(UNIT2), which may have unresolved references. In this example, references to f1() and f4() in USERID.PLAN9.LOADE(UNIT0) are unresolved. Compile and bind each unit by using the EDCCB procedure as follows:

```

//COMP0 EXEC EDCCB,
//      CPARAM='CSECT(MYPROG) ',
//      BPARAM='LET,CALL(NO),ALIASES(ALL) ',
//      INFILE='USERID.PLAN9.C(UNIT0) ',
//      OUTFILE='USERID.PLAN9.LOADE(UNIT0),DISP=SHR'
//COMP1 EXEC EDCCB,
//      CPARAM='CSECT(MYPROG) ',
//      BPARAM='LET,CALL(NO),ALIASES(ALL) ',
//      INFILE='USERID.PLAN9.C(UNIT1) ',
//      OUTFILE='USERID.PLAN9.LOADE(UNIT1),DISP=SHR'
//COMP2 EXEC EDCCB,
//      CPARAM='CSECT(MYPROG) ',
//      BPARAM='LET,CALL(NO),ALIASES(ALL) ',
//      INFILE='USERID.PLAN9.C(UNIT2) ',
//      OUTFILE='USERID.PLAN9.LOADE(UNIT2),DISP=SHR'

```

The CALL(NO) option prevents autocall processing.

---

## 2. Perform the final single bind to produce the executable program MYPROG by using the CBCB procedure:

You have two methods for building the program.

- a. Explicit include: In this method, when you invoke the CBCB procedure, you use include cards to explicitly specify all the program objects that make up this executable. Automatic library call is done only for the non-XPLINK data sets CEE.SCEELKED, CEE.SCEELKEX, and CEE.SCEECPP because those are the only libraries pointed to by ddname SYSLIB. Using CBCXB for XPLINK, automatic library is done only for CEE.SCEEBND2. For example:

```

//BIND EXEC CBCB,
//      OUTFILE='USERID.PLAN9.LOADE,DISP=SHR'
//INPGM DD DSN=USERID.PLAN9.LOADE,DISP=SHR
//SYSIN DD *
INCLUDE INPGM(UNIT0)
INCLUDE INPGM(UNIT1)
INCLUDE INPGM(UNIT2)
NAME MYPROG(R)
/*

```

- b. Library search: In this method, you specify the compile unit that contains your main() function, and allocate your object library to ddname SYSLIB. The binder performs a library search and includes additional members from your object library, and generates the output program object. You invoke the binder as follows:

```

//BIND EXEC CBCB,
//      OUTFILE='USERID.PLAN9.LOADE,DISP=SHR'
//INPGM DD DSN=USERID.PLAN9.LOADE,DISP=SHR
//SYSLIB DD
//      DD
//      DD
//      DD DSN=USERID.PLAN9.LOADE,DISP=SHR
//SYSIN DD *
INCLUDE INPGM(UNIT0)
NAME MYPROG(R)
/*

```

## Advantage

Binding a set of partially bound program objects into a fully bound program object is faster than binding object modules into a fully bound program object. For example, a central build group can create the partially bound program objects. You can then use these program objects and their changed object modules to create a development program object.

## Steps for building and using a DLL under z/OS batch

Perform the following steps to build USERID.PLAN9.C(UNIT1) and USERID.PLAN9.C(UNIT2) into DLL USERID.PLAN.LOADE(ONETWO), which exports functions f1(), f2(), f3() and f4(). Build USERID.PLAN9.C(UNIT0) into a program which dynamically links to functions f1() and f4() defined in the DLL build and use a DLL under z/OS batch.

1. Compile USERID.PLAN9.C(UNIT1) and USERID.PLAN9.C(UNIT2) to generate the object modules USERID.PLAN9.OBJ(UNIT1) and USERID.PLAN9.OBJ(UNIT2), which define the functions to be exported. Use the EDCC procedure as follows:

```
/* Compile UNIT1
//CC1 EXEC EDCC,
//      CPARM='OPTF(DD:OPTIONS)',
//      INFILE='USERID.PLAN9.C(UNIT1)',
//      OUTFILE='USERID.PLAN9.OBJ(UNIT1),DISP=SHR'
//COMPILE.OPTIONS DD *
//      LIST RENT LONGNAME EXPORTALL
*/
/* Compile UNIT2
//CC2 EXEC EDCC,
//      CPARM='OPTF(DD:OPTIONS)',
//      INFILE='USERID.PLAN9.C(UNIT2)',
//      OUTFILE='USERID.PLAN9.OBJ(UNIT2),DISP=SHR'
//COMPILE.OPTIONS DD *
//      LIST RENT LONGNAME EXPORTALL
*/
```

2. Bind USERID.PLAN9.OBJ(UNIT1) and USERID.PLAN9.OBJ(UNIT2) to generate the DLL ONETWO:

```
/* Bind the DLL
//BIND1 EXEC CBCB,
//      BPARM='CALL,DYNAM(DLL)',
//      OUTFILE='USERID.PLAN9.LOADE(ONETWO),DISP=SHR'
//INOBJ DD DISP=SHR,DSN=USERID.PLAN9.OBJ
//SYSDEFSD DD DISP=SHR,DSN=USERID.PLAN9.IMP(ONETWO)
//SYSLIN DD *
//      INCLUDE INOBJ(UNIT1)
//      INCLUDE INOBJ(UNIT2)
//      NAME ONETWO(R)
/*
```

When you bind code with exported symbols, you must specify the binder option DYNAM(DLL). You must also allocate the definition side-deck DD SYSDEFSD to define the definition side-deck where the IMPORT control statements are to be written.

In addition to the DLL being generated, a list of IMPORT control statements is written to DD SYSDEFSD. One IMPORT control statement is written for each

exported symbol. These generated control statements will be included later as input to the bind step of an application that uses this DLL, so that it can import the symbols.

3. Compile USERID.PLAN9.C(UNIT0) so that it may import unresolved symbols, and bind with the file of IMPORT control statements from the DLLs build:

```
/* Compile the DLL user
//CC1 EXEC EDCC,
//      CPARM='OPTF(DD:OPTIONS)',
//      INFILE='USERID.PLAN9.C(UNIT0)',
//      OUTFILE='USERID.PLAN9.OBJ(UNIT0),DISP=SHR'
//COMPILE.OPTIONS DD *
      LIST RENT LONGNAME DLL
/*
/* Bind the DLL user with input IMPORT statements from the DLL build
//BIND1 EXEC CBCB,
//      BPARM='CALL,DYNAM(DLL)',
//      OUTFILE='USERID.PLAN9.LOADE,DISP=SHR'
//INOBJ DD DISP=SHR,DSN=USERID.PLAN9.OBJ
//IMP DD DISP=SHR,DSN=USERID.PLAN9.IMP
//SYSLIN DD *
      INCLUDE INOBJ(UNIT0)
      INCLUDE IMP(ONETWO)
      ENTRY CEESTART
      NAME DLL12USR(R)
/*
```

---

### Advantage

The bind time advantage of using DLLs is that you only need to rebuild the DLL with the changed code in it. You do not need to rebuild all applications that use the DLL in order to use the changed code.

## Build and use a 64-bit application under z/OS batch

Creating a 64-bit application under z/OS batch is similar to creating a 31-bit application. There are, however, some subtle differences, which the following C++ example demonstrates.

As of z/OS C/C++ V1R6, new PROCs are available for binding and running with 64-bit applications. There are no new PROCs for a 64-bit compile (without binding or running) but you can use the previously existing C and C++ PROCs, along with the LP64 compiler option, to create 64-bit object files that can then be used with the new 64-bit enabled PROCs. Then, rather than using the regular binding PROCs (such as CBCB and EDCCBG), you need to use the new 64-bit PROCs for binding; for example, CBCQB and EDCQCBG.

**Example:** The following example will now show you how to implement the above instructions. In this example, we use the CBCC PROC and the LP64 compiler option for our first 64-bit compile, and the CBCQCBG PROC to compile another source file in 64-bit mode, bind it (along with the first object file we produced), and finally run the resulting load module.

```
#include <iostream>
void lp64_function() {
#ifdef _LP64
    std::cout << "Hello World, z/OS has 64-bit programs now!" << std::endl;
```

```

#else
    std::cout << "Uh oh, someone didn't compile this file with LP64" << std::endl;
#endif
}

HELLO2.C
void lp64_function();
int main() {
    lp64_function();
}

//USERID   JOB (641A,2317),'Programmer Name',REGION=128M,
//         CLASS=B,MSGCLASS=S,NOTIFY=&SYSUID;,MSGLEVEL=(1,1)
//ORDER JCLLIB ORDER=(CBC.SCCNPRC)
//*-----
//* C++ Compile using LP64 compiler option
//*-----
//COMPILE EXEC CBCC,
//         INFILE='USERID.LP64.SOURCE(HELLO1)',
//         OUTFILE='USERID.LP64.OBJECT(HELLO1),DISP=SHR',
//         CPARM='OPTFILE(DD:OPTIONS)'
//OPTIONS DD DATA,DLM='>'
//         LP64
/>
//*-----
//* C++ 64-bit Compile, Bind, and Go Step
//*-----
//COBINDGO EXEC CBCQCBG,
//         INFILE='USERID.LP64.SOURCE(HELLO2)',
//         OUTFILE='USERID.LP64.LOAD(HELLO),DISP=SHR'
//BIND.SYSIN DD DATA,DLM='>'
//         INCLUDE OBJECT(HELLO1)
/>
//OBJECT   DD DSN=USERID.LP64.OBJECT,DISP=SHR

```

## Build and use a 64-bit application with IPA under z/OS batch

**Example:** This example shows you how to IPA Compile both a C source file and a C++ source file in 64-bit mode, then IPA Link them, bind them (in 64-bit mode), and run the resulting load module.

This example also shows that when you want to create an IPA optimized program that makes use of calls to standard library functions, you need to explicitly let IPA know where to find the libraries that it will link with. The location of the standard library functions is not included by default in the IPA Link PROCs because if you do not actually ever call a standard library function, IPA will spend time analyzing the unused libraries before realizing your program does not need them, thereby unnecessarily slowing down your compilation time. If you are building a C++ program and do not tell IPA where to find the libraries it needs at IPA Link time, the IPA Linker will complain about the unresolved symbols it cannot find. You can tell IPA where the standard libraries are by adding the following lines to the CBCXI or EDCXI job steps in your JCL:

```

//SYSIN   DD DATA,DLM='>'
//         INCLUDE OBJECT(HELLO)
//         INCLUDE SYSLIB(C64,IOSX64)
//         INCLUDE SYSLIB(CELQSCPP,CELQS003)
/>
//SYSLIB  DD DSN=CEE.SCEEEND2,DISP=SHR
//         DD DSN=CEE.SCEELIB,DISP=SHR
//         DD DSN=CBC.SCLBSID,DISP=SHR
//OBJECT  DD DSN=USER.TEST.OBJECT,DISP=SHR

```

**Note:** The USER.TEST.OBJECT data set and the HELLO PDS member are meant to represent the object file(s) for your application, which you should have



created using a previous IPA Compile step.

**Example:** The following example will now show you how to implement the above instructions.

```
//USERID JOB (641A,2317),'Programmer Name',REGION=128M,
//          CLASS=B,MSGCLASS=S,NOTIFY=&SYSUID;,MSGLEVEL=(1,1)
//ORDER JCLLIB ORDER=(CBC.SCCNPRC)
/*-----
/* 64-bit C IPA Compile
/*-----
//IPACOMP1 EXEC EDCC,
//          OUTFILE='USERID.IPA.LP64.OBJECT(OBJECT1),DISP=SHR',
//          CPARM='OPTFILE(DD:OPTIONS)'
//SYSIN DD DATA,DLM='>'

#include <time.h>
#include <string.h>
int get_time_of_day(char* output) {

    time_t    time_val;
    struct tm* time_struct;
    char*     time_string;

    if ( -1 != time(&time_val;) ) {

        time_struct = localtime(&time_val;);

        if ( NULL != time_struct ) {

            time_string = asctime(time_struct);

            if ( NULL != time_string ) {

                strcpy(output, time_string);
                output[strlen(output) - 1] = 0;

                return 0;
            }
        }
    }

    return 1;
}
/>
//OPTIONS DD DATA,DLM='>'
IPA(NOOBJECT,NOLINK) LP64 LONGNAME OPT
/>
/*-----
/* 64-bit C++ IPA Compile with very high optimization
/*-----
//IPACOMP2 EXEC CBCC,
//          OUTFILE='USERID.IPA.LP64.OBJECT(OBJECT2),DISP=SHR',
//          CPARM='OPTFILE(DD:OPTIONS)'
//SYSIN DD DATA,DLM='>'

#include <iostream>
#include <string>

using std::cout;
using std::endl;
using std::string;

extern "C" int get_time_of_day(char*);

int main() {
```

```

char* tod;

tod = new char[100];

if ( 0 == get_time_of_day(tod) ) {

    cout << "The current time is: " << tod << endl;

} else {

    cout << "Error: Could not determine the time" << endl;

}

delete tod;

return 0;
}
/>
//OPTIONS DD DATA,DLM='/>'
IPA(NOOBJECT,NOLINK) LP64 OPT(3)
/>
/*-----
/* 64-bit C++ IPA Link
/*-----
//IPALINK EXEC CBCXI,
//      OUTFILE='USERID.IPALINK.LP64.OBJECT(IPAOBJ),DISP=SHR',
//      IPARM='IPA(LEVEL(2),MAP) LONGNAME'
//SYSIN DD DATA,DLM='/>'
INCLUDE OBJECT(OBJECT1)
INCLUDE OBJECT(OBJECT2)
INCLUDE SYSLIB(C64,IOSX64)
INCLUDE SYSLIB(CELQSCPP,CELQS003)
/>
//SYSLIB DD DSN=CEE.SCEEEND2,DISP=SHR
//      DD DSN=CEE.SCEELIB,DISP=SHR
//      DD DSN=CBC.SCLBSID,DISP=SHR
//OBJECT DD DSN=USERID.IPA.LP64.OBJECT,DISP=SHR
/*-----
/* C++ 64-bit Bind and Go Step
/*-----
//BINDGO EXEC CBCQBG,
//      INFILE='USERID.IPALINK.LP64.OBJECT(IPAOBJ)',
//      OUTFILE='USERID.LP64.LOAD(FINALEXE),DISP=SHR'
//SYSIN DD DATA,DLM='/>'
INCLUDE OBJECT(IPAOBJ)
/>
//OBJECT DD DSN=USERID.IPA.LP64.OBJECT,DISP=SHR

```

## Using the non-XPLINK version of the Standard C++ Library and z/OS batch

A non-XPLINK Standard C++ Library DLL is available that provides Standard C++ Library support for CICS and IMS. The CICS and IMS subsystems do not support XPLINK linkage, rendering the XPLINK Standard C++ Library DLL supplied with the compiler inoperable under both subsystems. The non-XPLINK Standard C++ Library DLL allows support for the Standard C++ Library in the CICS and IMS subsystems, as of z/OS V1R2. Since CICS and IMS do not support XPLINK linkage, a non-XPLINK DLL enables the Standard C++ Library under these subsystems.

All non-XPLINK C++ PROCs containing bind and pre-link steps need to be invoked with the STDLIBSD PROC variable set to c128n, or overridden in order to use the non-XPLINK Standard C++ Library DLL. These PROCs are: CBCB, CBCBG, CBCCB, CBCCBG, CBCCL, CBCCLG, CBCL, CBCLG and CCNPD1B.

The appropriate DD statements in these PROCs must be overridden:

- For a bind step, the non-XPLINK side deck must override the XPLINK side-deck or the SYSLIN concatenation.
- For a pre-link step, the non-XPLINK side deck must override the XPLINK side deck or the SYSIN concatenation.

The following concatenations added to the calling JCL will override the appropriate DD statement of the corresponding CBC PROC:

#### **CBCB, CBCBG**

```
//SYSLIN DD
// DD DSN=&LIBPRFX..SCEELIB(C128N),DISP=SHR
```

#### **CBCCB, CBCCBG**

```
//BIND.SYSLIN DD
// DD DSN=&LIBPRFX..SCEELIB(C128N),DISP=SHR
```

#### **CBCL, CBCLG**

```
//SYSLIN DD
// DD DSN=&LIBPRFX..SCEELIB(C128N),DISP=SHR
```

#### **CBCCL, CBCCLG**

```
//PLKED.SYSLIN DD
// DD DSN=&LIBPRFX..SCEELIB(C128N),DISP=SHR
```

The following concatenation added to the calling JCL will override the appropriate DD statement of the corresponding CCN PROC. Note that CICS does not support PDF.

#### **CCNPD1B**

```
//SYSLIN DD
// DD DSN=&LIBPRFX..SCEELIB(C128N),DISP=SHR
```

### **Restrictions concerning use of non-XPLINK Standard C++ Library DLL**

The following is a list of restrictions:

- No enhanced ASCII functionality support:  
The non-XPLINK Standard C++ Library DLL does not provide enhanced ASCII functionality support as ASCII run-time functions require XPLINK linkage. Classes and functions sensitive to character encoding are provided in EBCDIC alone in the non-XPLINK DLL.
- No PDF PROC support for CICS:  
CICS does not support Profile Directed Feedback (PDF). The non-XPLINK PDF PROC, CCNPD1B, cannot be used with CICS. The XPLINK PDF CCNXP1B PROC and the 64-bit PDF CCNQPD1B PROC cannot be used with CICS as well.

## **Steps for rebinding a changed compile unit under z/OS batch**

**Before you begin:** Make a change to a single source file and rebuild the application.

Perform the following steps to recompile the single changed source file and make a replacement of its binder sections in the program:

1. Recompile the single changed source file. Use the CSECT compiler option to ensure that each section is named for purposes of rebinding. For example,

assume that you have made a change to USERID.PLAN9.C(UNIT1). Recompile the source file using the EDCC procedure as follows:

```
/* Compile UNIT1 user
//CC EXEC EDCC,
//          CPARM='OPTF(DD:OPTIONS)',
//          INFILE='USERID.PLAN9.C(UNIT1)',
//          OUTFILE='USERID.PLAN9.OBJ(UNIT1),DISP=SHR'
//COMPILE.OPTIONS DD *
LIST RENT LONGNAME DLL CSECT(MYPROG)
/*
```

---

2. Rebind only the changed compile unit into the executable program, which replaces its corresponding binder sections in the program object:

```
//BIND EXEC CBCB,
//          OUTFILE='USERID.PLAN9.LOADE,DISP=SHR'
//OLDPGM DD DSN=USERID.PLAN9.LOADE,DISP=SHR
//NEWOBJ DD DSN=USERID.PLAN9.OBJ,DISP=SHR
//SYSIN DD *
INCLUDE NEWOBJ(UNIT1)
INCLUDE OLDPGM(MYPROG)
NAME NEWPGM(R)
/*
```

---

### Advantage

Rebinds are fast because most of the program is already bound, and none of the intermediate object modules are retained.

## Writing JCL for the binder

You can use cataloged procedures rather than supply all the JCL required for a job step. However, you can use JCL statements to override the statements of the cataloged procedure.

Use the EXEC statement in your JCL to invoke the binder. The EXEC statement to invoke the binder is:

```
//BIND EXEC PGM=IEWL
```

Use PARM parameter for the EXEC statement to select one or more of the optional facilities that the binder provides.

**Example:** You can specify the OPTIONS option on the PARM parameter to read binder options from the ddname OPTS, as follows:

```

//BIND1 EXEC PGM=IEWL,PARM='OPTIONS=OPTS'
//OPTS DD *
        AMODE=31,MAP
        RENT,DYNAM=DLL
        CASE=MIXED,COMPAT=CURR
/*
//SYSLIB DD DISP=SHR,DSN=CEE.SCEELKEX
// DD DISP=SHR,DSN=CEE.SCEELKED
// DD DISP=SHR,DSN=CEE.SCEECPP
//SYSLIN DD DISP=SHR,DSN=USERID.PLAN9.OBJ(P1)
// DD DISP=SHR,DSN=CBC.SCLBSID(IOSTREAM)
//SYSLMOD DD DISP=SHR,DSN=USERID.PLAN9.LOADE(PROG1)
//SYSPRINT DD SYSOUT=*

```

In the example above, object module P1, which was compiled NOXPLINK, is bound using the IOSTREAM DLL definition side-deck. The Language Environment non-XPLINK run-time libraries SCEELKED, SCEELKEX, and SCEECPP are statically bound to produce the program object PROG1.

**Example:** If the object module P1 was compiled XPLINK, then the JCL would be:

```

|
| //BIND1 EXEC PGM=IEWL,PARM='OPTIONS=OPTS'
| //OPTS DD *
| AMODE=31,MAP
| RENT,DYNAM=DLL
| CASE=MIXED,COMPAT=CURR
| LIST=NOIMP
| /*
| //SYSLIB DD DSN=CEE.SCEEBND2,DISP=SHR
| //SYSLIN DD DSN=USERID.PLAN9.OBJ(P1),DISP=SHR
| // DD DSN=CEE.SCEELIB(CELHSCPP),DISP=SHR
| // DD DSN=CEE.SCEELIB(CELHS003),DISP=SHR
| // DD DSN=CEE.SCEELIB(CELHS001),DISP=SHR
| // DD DISP=SHR,DSN=CBC.SCLBSID(IOSTREAM)
| //SYSLMOD DD DISP=SHR,DSN=USERID.PLAN9.LOADE(PROG1)
| //SYSPRINT DD SYSOUT=*
|

```

**Example:** If the object module P1 was compiled LP64, then the JCL would be:

```

|
| //BIND1 EXEC PGM=IEWL,PARM='OPTIONS=OPTS'
| //OPTS DD *
| AMODE=64,MAP
| RENT,DYNAM=DLL
| CASE=MIXED,COMPAT=CURR
| LIST=NOIMP
| /*
| //SYSLIB DD DSN=CEE.SCEEBND2,DISP=SHR
| //SYSLIN DD DSN=USRID.PLAN9.OBJ(P1),DISP=SHR
| // DD DSN=CEE.SCEELIB(CELQHSCPP),DISP=SHR
| // DD DSN=CEE.SCEELIB(CELQHS003),DISP=SHR
| // DD DSN=CBC.SCLBSID(IOSX64),DISP=SHR
| // DD DISP=SHR,DSN=CBC.SCLBSID(IOSTREAM)
| //SYSLMOD DD DISP=SHR,DSN=USERID.PLAN9.LOADE(PROG1)
| //SYSPRINT DD SYSOUT=*
|

```

For more information on the files given, please refer to “LP64 libraries” on page 387.

The binder always requires three standard data sets. You must define these data sets on DD statements with the ddnames SYSLIN, SYSLMOD, and SYSPRINT.

**Example:** A typical sequence of job control statements for binding an object module into a program object is shown below. In the following non-XPLINK example, the

binder control statement `NAME` puts the program object into the PDSE `USER.LOADE` with the member name `PROGRAM1`.

```
//BIND EXEC PGM=IEWL,PARM='MAP'
//SYSPRINT DD * << out: binder listing
//SYSDEFSD DD DUMMY << out: generated IMPORTs
//SYSLMOD DD DISP=SHR,DSN=USERID.PLAN9.LOADE << out: PDSE of executables
//SYSLIB DD DISP=SHR,DSN=CEE.SCEELKED << in: autocall libraries to search
// DD DISP=SHR,DSN=CEE.SCEELKEX
// DD DISP=SHR,DSN=CEE.SCEECPP
//INOBJ DD DISP=SHR,DSN=USERID.PLAN.OBJ << in: compiler object code
//SYSLIN DD*
INCLUDE INOBJ(UNIT0)
INCLUDE INOBJ(UNIT1)
INCLUDE INOBJ(UNIT2)
ENTRY CEESTART
NAME PROGRAM1(R)
/*
```

You can explicitly include members from a data set like `USERID.PLAN.OBJ`, as is done above. If you want to be more flexible and less explicit, include only one member, typically the one that contains the entry point (e.g. `main()`). Then you can add `USERID.PLAN.OBJ` to the `SYSLIB` concatenation so that a library search brings in the remaining members.

---

## Binding under TSO using CXXBIND

This section describes how to bind your z/OS XL C++ or z/OS XL C program in TSO by invoking the `CXXBIND REXX EXEC`. This `REXX EXEC` invokes the binder and creates an executable program object.

**Note:** This `REXX EXEC` does not support 64-bit binding. You must use the `PROCs` or `c89`, `cc`, `c++`, or `cxx` commands under UNIX System Services to perform 64-bit binding.

If you specify a data set name in an option, and the high-level qualifier of the data set is not the same as your user prefix, you must use the fully qualified name of the data set and place single quotation marks around the entire name.

If you specify a z/OS UNIX file name in an option, it must be an absolute file name; it must begin with a slash (`/`). You can include commas and special characters in file names, but you must enclose file names that contain special characters or commas in single quotes. If a single quote is part of the file name, you must specify the quote twice.

The syntax for the `CXXBIND EXEC` is:

```

CXXBIND OBJ ( ( 'input-object' ) )

```

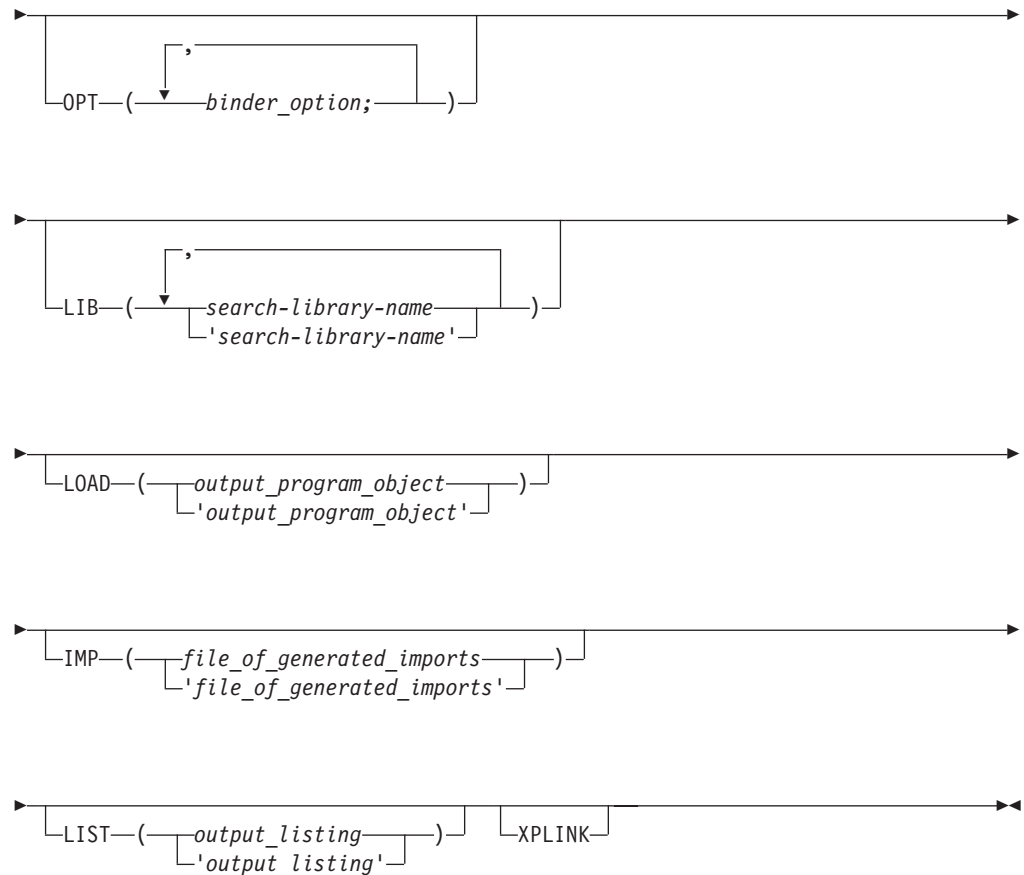

**OBJ** You must always specify the input file names by using the OBJ keyword parameter. Each input file must be one of the following:

- An object module that can be a PDS member, a sequential data set, or a z/OS UNIX file
- A load module that is a PDS member
- A program object that can be a PDSE member or a z/OS UNIX file
- A text file that contains binder statements. The file can be a PDS member, a sequential data set, or a z/OS UNIX file

**OPT** Use the OPT keyword parameter to specify binder options. For example, if you want the binder to use the MAP option, specify the following:

```
CXXBIND OBJ(PLAN9.OBJ(PROG3)) OPT('MAP')...
```

**LIB** Use the LIB keyword parameter to specify the PDS and PDSE libraries that the binder should search to resolve unresolved external references during a library search of the DD SYSLIB.

The default libraries that are used when the XPLINK option is not specified are the CEE.SCEELKED, CEE.SCEELKEX, and CEE.SCEECPP C/C++ libraries and the CBC.SCLBSID C++ class library. The default libraries that are used when the XPLINK option is specified are the CEE.SCEEBND2 and CEE.SCEELIB C/C++ libraries and the CBC.SCLBSID C++ class library . The default

library names are added to the ddname SYSLIB concatenation if library names are specified with the LIB keyword parameter.

|        |  |
|--------|--|
| LOAD   | Use the LOAD keyword parameter to specify where the resultant executable program object (which must be a PDSE member, or a z/OS UNIX file) should be stored.                       |
| IMP    | Use the IMP keyword parameter to specify where the generated IMPORT control statements should be written.  |
| LIST   | Use the LIST keyword parameter to specify where the binder listing should be written. If you specify *, the binder directs the listing to your console.                            |
| XPLINK | Use the XPLINK keyword parameter when you are building an XPLINK executable program object. Specifying XPLINK will change the default libraries as described under the LIB option. |

## TSO example

Figure 37 shows the example source files PLAN9.C(UNIT0), PLAN9.C(UNIT1), and PLAN9.C(UNIT2), that are used to illustrate all of the TSO examples that follow.

```
/* file: USERID.PLAN9.C(UNIT0) */
#include <stdio.h>
extern int f1(void);
extern int f4(void);
int main(void) {
int rc1;
int rc4;
rc1 = f1();
rc4 = f4();
if (rc1 != 1) printf("fail rc1 is %d\n",rc1);
if (rc4 != 40) printf("fail rc4 is %d\n",rc4);
return 0;
}

/* file: USERID.PLAN9.C(UNIT1) */
int f1(void) { return 1; }

/* file: USERID.PLAN9.C(UNIT2) */
int f2(void) { return 20;}
int f3(void) { return 30;}
int f4(void) { return f2()*2; /* 40 */ }
```

Figure 37. Example Source Files

## Steps for single final bind under TSO

**Before you begin:** Compile each source file.

Perform the following steps to complete a single final bind of everything:

1. Compile each unit to generate the object modules PLAN9.OBJ(UNIT0), PLAN9.OBJ(UNIT1), and PLAN9.OBJ(UNIT2). Use the CC REXX exec as follows:

```
CC PLAN9.C(UNIT0) OBJECT(PLAN9.OBJ) CSECT(MYPROG)
CC PLAN9.C(UNIT1) OBJECT(PLAN9.OBJ) CSECT(MYPROG)
CC PLAN9.C(UNIT2) OBJECT(PLAN9.OBJ) CSECT(MYPROG)
```
2. Perform a final single bind to produce the executable program PLAN9.LOADE(MYPROG). Use the CXXBIND REXX exec as follows:



```
CXXBIND OBJ(PPLAN9.OBJ(UNIT0),PLAN9.OBJ(UNIT1),PLAN9.OBJ(UNIT2))
LOAD(PPLAN9.LOADE(MYPROG))
```

---

### Advantage

This method is simple, and is consistent with existing methods of building applications, such as makefiles.

## Steps for binding each compile unit under TSO

**Before you begin:** Compile and bind each source file.

Perform the following steps to complete a final bind of all the partially bound units:

1. Compile and bind each source file to generate the partially bound program objects PLAN9.LOADE(UNIT0), PLAN9.LOADE(UNIT1), and PLAN9.LOADE(UNIT2), which may have unresolved references. In this example, references to f1() and f4() in PLAN9.LOADE(UNIT0) are unresolved. Compile and bind each unit by using the CC and CXXBIND REXX execs as follows:

```
CC PLAN9.C(UNIT0) OBJECT(PPLAN9.OBJ) CSECT(MYPROG)
CXXBIND OBJ(PPLAN9.OBJ(UNIT0)) OPT('LET,CALL(NO)')
LOAD(PPLAN9.LOADE(UNIT0))
```

```
CC PLAN9.C(UNIT1) OBJECT(PPLAN9.OBJ) CSECT(MYPROG)
CXXBIND OBJ(PPLAN9.OBJ(UNIT1)) OPT('LET,CALL(NO)')
LOAD(PPLAN9.LOADE(UNIT1))
```

```
CC PLAN9.C(UNIT2) OBJECT(PPLAN9.OBJ) CSECT(MYPROG)
CXXBIND OBJ(PPLAN9.OBJ(UNIT2)) OPT('LET,CALL(NO)')
LOAD(PPLAN9.LOADE(UNIT1))
```

The CALL(NO) option prevents autocall processing.

---

2. Perform the final single bind to produce the executable program MYPROG by using the CXXBIND REXX exec:

```
CXXBIND OBJ(PPLAN9.LOADE(UNIT0), PLAN9.LOADE(UNIT1), PLAN9.LOADE(UNIT2))
LOAD(PPLAN9.LOADE(MYPROG))
```

---

### Advantage

Binding a set of partially bound program objects into a fully bound program object is faster than binding object modules into a fully bound program object. For example, a central build group can create the partially bound program objects. You can then use these program objects and their changed object modules to create a development program object.

## Steps for building and using a DLL under TSO

Perform the following steps to build PLAN9.C(UNIT1) and PLAN9.C(UNIT2) into DLL PLAN9.LOADE(ONETWO) which exports functions f1(), f2(), f3() and f4(). Then build PLAN9.C(UNIT0) into a program which dynamically links to functions f1() and f4() defined in the DLL.

1. Compile PLAN9.C(UNIT1) and PLAN9.C(UNIT2) to generate the object modules PLAN9.OBJ(UNIT1) and PLAN9.OBJ(UNIT2) which have functions to be exported. Use the CC REXX exec as follows:

```
CC PLAN9.C(UNIT1) OBJECT(PPLAN9.OBJ) EXPORTALL, LONGNAME, DLL, CSECT(MYPROG)
CC PLAN9.C(UNIT2) OBJECT(PPLAN9.OBJ) EXPORTALL, LONGNAME, DLL, CSECT(MYPROG)
```

---

2. Bind PLAN9.OBJ(UNIT1) and PLAN9.OBJ(UNIT2) to generate the DLL PLAN9.LOADE(ONETWO):  

```
CXXBIND OBJ(PPLAN9.LOADE(UNIT0), PLAN9.LOADE(UNIT1)) IMP (PLAN9.IMP(ONETWO))  
LOAD(PLAN9.LOADE(ONETWO))
```

When you bind code with exported symbols, you must specify the binder option DYNAM(DLL). You must also use the CXXBIND IMP option to define the definition side-deck where the IMPORT control statements are to be written.

- 
3. Compile PLAN9.C(UNIT0) so that it may import unresolved symbols, and bind with PLAN9.IMP(ONETWO), which is the definition side-deck containing IMPORT control statements from the DLL build:

```
CC PLAN9.C(UNIT0) OBJECT(PPLAN9.OBJ) CSECT(MYPROG),DLL  
CXXBIND OBJ(PPLAN9.LOADE(UNIT0), PLAN9.IMP(ONETWO)) LOAD(PLAN9.LOADE(DLL12USR))
```

---

### Advantage

The bind time advantage of using DLLs is that you only need to rebuild the DLL with the changed code in it. You do not need to rebuild all applications that use the DLL in order to use the changed code.

## Steps for rebinding a changed compile unit under TSO

**Before you begin:** Make a change to a single source file and rebuild the application.

Perform the following steps to recompile the single changed source file and make a replacement of its binder sections in the program:

1. Recompile the single changed source file. Use the CSECT compiler option to ensure that each section is named for purposes of rebinding. For example, assume that you have made a change to PLAN9.C(UNIT1). Recompile PLAN9.C(UNIT1) by using the CC REXX exec as follows:

```
CC PLAN9.C(UNIT1) OBJECT(PPLAN9.OBJ) CSECT(MYPROG)
```

---

2. Rebind only the changed source file into the executable program, which replaces its corresponding binder sections in the program object:

```
CXXBIND OBJ(PPLAN9.OBJ(UNIT1), PLAN9.LOADE(MYPROG))  
LOAD(PLAN9.LOADE(NEWPROG))
```

---

### Advantage

Rebinds are fast because most of the program is already bound, and none of the intermediate object modules are retained.

---

## Chapter 10. Binder processing

You can bind any z/OS XL C/C++ object module or program object.

Object files with long name symbols, reentrant writable static symbols, and DLL-style function calls require additional processing to build global data for the application. You can always rebind if you don't require this additional processing. You can also re-bind if you used the binder for this additional processing and produced a program object (in other words, you didn't use the prelinker). If you used the prelinker and performed this additional processing, you cannot later rebind. If you have done additional processing and output it to a PDS, you cannot rebind it. For further information, refer to "About prelinking, linking, and binding" on page 11.

Various limits have been increased from the linkage-editor; for example, the z/OS V1R6 binder supports variable and function names up to 32767 characters long.

For the Writable Static Area (WSA), the binder assigns relative offsets to objects in the Writable Static Area and manages initialization information for objects in the Writable Static Area. The Writable Static Area is not loaded with the code. Language Environment run time requests it.

For C++, the binder collects constructor calls and destructor calls for static C++ objects across multiple compile units. C++ linkage names appear with the full signature in the binder listing. A cross reference of mangled versus demangled names is also provided.

For DLLs, the binder collects static DLL initialization information across multiple compile units. It then generates a function descriptor in the Writable Static Area for each DLL-referenced function, and generates a variable descriptor for each DLL-referenced variable. It accepts IMPORT control statements in its input to resolve dynamically linked symbols, and generates an IMPORT control statement for each exported function and variable.

The C++ compiler may generate internal symbols that are marked as exported. These symbols are for use by the run-time environment only and are not required by any user code. When these symbols are generated, if the binder option is DYNAM=DLL and the definition side-deck is not defined for the binder, the binder issues a message indicating the condition. If you are not building a DLL, you can use DYNAM=NO or you can ignore the message; or you can define a dummy side deck for the binder and then ignore the generated side deck.

| **Note:** When binding a DLL in z/OS UNIX System Services, specify **-WI,DLL** on the  
| command line.

| The z/OS UNIX file system support allows a library search of archive libraries that  
| were created with the ar utility. UNIX files can be specified on binder control  
| statements or specified directly on the compiler invocation command line.

C/C++ code is rebindable, provided all the sections are named. You can use the CSECT compiler option or the **#pragma csect** directive to name a section. If the GOFF option is active, then your CSECTs will automatically be named. See "CSECT | NOCSECT" on page 86.

**Note:** If you do not name all the sections and you try to rebind, the binder cannot replace private or unnamed sections. The result is a permanent accumulation of dead code and of duplicate functions.

The RENAME control statement may rename specified unresolved function references to a definition of a different name. This is especially helpful when matching function names that should be case insensitive. The RENAME statement does not apply to rebinds. If you rebind updated code with the original name, you will need another RENAME control statement to make references match their definitions.

The binder starts its processing by reading object code from primary input (DD SYSLIN). It accepts the following inputs:

- Object modules (compiler output from C/C++ and other languages)
- Load modules (previously link-edited by the Linkage-Editor)
- Program Objects (previously bound by the binder)
- Binder control statements
- Generalized Object File Format (GOFF) files

During the processing of primary input, control statements can control the binder processing. For example, the INCLUDE control statement will cause the binder to read and include other code.

Among other processing, the binder records whether or not symbols (external functions and variables) are currently defined. During the processing of primary input, the AUTOCALL control statement causes a library to be immediately searched for members that contain a definition for an unresolved symbol. If such a member is found, the binder reads it as autocall input before it processes more primary or secondary input.

After the binder processes primary input, it searches the libraries that are included in DD SYSLIB for definitions of unresolved symbols, unless you specified the options NOCALL or NORES. This is final autocall processing. The binder may read library members that contain the sought definition as autocall input.

Final autocall processing drives DD SYSLIB autocall resolution one or two times. After the first DD SYSLIB autocall resolution is complete, symbols that are still unresolved are subject to renaming. If renaming is done, DD SYSLIB autocall is driven a second time to resolve the renamed symbols.

After the binder completes final autocall (if autocall takes place), it processes the IMPORT control statements that were read in to match unresolved DLL type references. It then marks those symbols as being resolved from DLLs.

Finally, the binder generates an output program object. It stores the program object in a z/OS UNIX file, or as a member of the program library (PDSE) specified on the DD SYSLMOD statement. The Program Management Loader can load this program object into virtual storage to be run. The binder can generate a listing. It can also generate a file of IMPORT control statements for symbols exported from the program that are to be used to build other applications that use this DLL.

---

## Linkage considerations

The binder will check that a statically bound symbol reference and symbol definition have compatible attributes. If a mismatch is detected, the binder will issue a diagnostic message. This attribute information is contained within the binder input files, such as object files, program objects, and load modules.

For C and C++, the default attribute is based on the XPLINK, NOXPLINK, LP64 and ILP32 options.

The attributes can also be set for assembly language. Refer to the *HLASM Language Reference*, SC26-4940 for further information.

---

## Primary input processing

The binder obtains its primary input from the contents of the data sets that are defined by the DD SYSLIN.

Primary input to the binder can be a sequential data set, a member of a partitioned data set, or an instream data set. The primary input must consist of one or more separately compiled program objects, object modules, load modules or binder control statements.

## C or C++ object module as input

The binder accepts object modules generated by the XL C or XL C++ compiler (as well as other compilers or assemblers) as input. All initialization information and relocation information for both code and the Writable Static Area is retained, which makes each compile unit fully rebindable.

---

## Secondary input processing

Secondary input to the binder consists of files that are not part of primary input but are included as input due to the INCLUDE control statement.

The binder obtains its secondary input by reading the members from libraries of object modules (which may contain control statements), load modules, or program objects.

## Load module as input

The binder accepts a load module that was generated by the Linkage-Editor input, and converts it into program object format on output.

**Note:** Object modules that define or refer to writable static objects that were processed by the prelinker and link-edited into a load module do not contain relocation information. You cannot rebind these compile units, or use them as input to the IPA Link step. See “Code that has been prelinked” on page 407 for more information on prelinked code and the binder.

## Program object as input

The binder accepts previously bound program objects as input. This means that you can recompile only a changed compile unit, and rebind it into a program without needing other unchanged compile units. See “Rebind a changed compile unit” on page 360 and “Rebindability” on page 401.

You can compile and bind each compile unit to a program object, possibly with unresolved references. To build the full application, you can then bind all the separate program objects into a single executable program object.

---

## Autocall input processing (library search)

The library search process is also known as *automatic library call*, or *autocall*. Unresolved symbols, including unresolved DLL-type references, may have their definitions within a library member that is searched during library search processing.

The library member that is expected to contain the definition is read. This may resolve the expected symbol, and also other symbols which that library member may define. Reading in the library member may also introduce new unresolved symbols.

## Incremental autocall processing (AUTOCALL control statement)

Traditionally, autocall has been considered part of the final bind process. However, through the use of the AUTOCALL control statement, you can invoke autocall at any time during the include process.

The binder searches the libraries that occur on AUTOCALL control statements immediately for unresolved symbols and DLL references, before it processes more primary or secondary input. See *z/OS MVS Program Management: User's Guide and Reference* for further information on the AUTOCALL control statement. After processing the AUTOCALL statement, if new unresolved symbols are found that cannot be resolved from within the library being processed, the library will not be searched again. To search the library again, another AUTOCALL statement or SYSLIB must indicate the same library.

## Final autocall processing (SYSLIB)

The binder performs final autocall processing of DD SYSLIB in addition to incremental autocall. It performs this processing after it completes the processing of DD SYSLIN.

DD SYSLIB defines the libraries of object modules, load modules, or program objects that the binder will search after it processes primary and secondary input.

The binder searches each library (PDS or PDSE) in the DD SYSLIB concatenation in order. The rules for searching for a symbol definition in a PDS or PDSE are as follows:

- If the library contains a C370LIB directory (@@DC370\$ or @@DC390\$) that was created using the C/C++ Object Library Utility, and the directory points to a member containing the definition for the symbol, that member is read.
- If the library has a member or alias with the same name as the symbol that is being searched, that member of the library is read.

You can use the LIBRARY control statement to suppress the search of SYSLIB for certain symbols, or to search an alternate library.

### Non-XPLINK libraries

The libraries described here are to be used only for binding non-XPLINK program modules.

For C and C++, you should include CEE.SCEELKEX and CEE.SCEELKED in your DD SYSLIB concatenation when binding your program. Those libraries contain the

Language Environment resident routines, which include those for callable services, initialization, and termination. CEE.SCEELKED has the uppercase (NOLONGNAME), 8-byte-or-less versions of the standard C library routines, for example PRINTF and @@PT@C. CEE.SCEELKEX has the equivalent case-sensitive long-named routines; for example, printf, pthread\_create.

For C++, you should also include the C++ base library in data set CEE.SCEECPP in your DD SYSLIB concatenation when binding your program. It contains the C++ base routines such as global operator new. The C++ class libraries are contained in the C128N member of the CEE.SCEELIB data set.

### **XPLINK libraries**

The libraries described here are to be used only for binding XPLINK program modules.

For C and C++, you must include CEE.SCEEBND2 in your DD SYSLIB concatenation when binding your program. This library contains the Language Environment resident routines, which include those for initialization and termination.

XPLINK C run-time and C++ base libraries are packaged as DLLs. Therefore, the bindings for those routines resolve dynamically. This is accomplished by providing definition side-decks (object modules containing IMPORT control statements). This is done using INCLUDE control statements in the binder primary or secondary input. Language Environment side decks reside in the CEE.SCEELIB data set.

The Language Environment routine definitions for callable services are contained in the CELHS001 member of the data set CEE.SCEELIB. For example, CEEGTST is contained here.

The C run-time library routine definitions for 32-bit programs are contained in the CELHS003 member of the data set CEE.SCEELIB, which contains NOLONGNAME and case-sensitive long-named routines (for example, printf, PRINTF, and pthread\_create are contained here). It also contains the C run-time library global variables; for example, environ.

For 32-bit C++ programs, you should also include the C++ base library side deck (member CELHSCPP in data set CEE.SCEELIB). It contains the C++ base routines such as global operator new.

The C++ class libraries are contained in the C128 member of the CEE.SCEELIB data set.

### **LP64 libraries**

The libraries described below are to be used only for binding LP64 program modules. LP64 is built upon the XPLINK linkage so the basic elements mentioned above still apply:

- As described above, in the simple XPLINK case, you must include CEE.SCEEBND2 in your DD SYSLIB concatenation when binding your programs.
- The 64-bit C++ libraries are packaged as DLLs, so INCLUDE statements must be used to resolve C and C++ run-time references.
- The 64-bit side decks are in the CEE.SCEELIB dataset.
- For 64-bit modules, the C run-time library definitions are contained in the CELQS003 member of the CEE.SCEELIB data set.



- The C++ base library side deck member for 64-bit is the CELQSCPP member of the CEE.SCEELIB data set.
- The C++ class libraries are contained in the C64 member of the CEE.SCEELIB data set.
- There is no 64-bit equivalent for the CELHS001 member.

## Rename processing

Rename processing is performed at the end of the first pass of final autocall processing of DD SYSLIB, when all possible references have been resolved with the names as they were on input. The binder renaming logic permits the conversion of unresolved non-DLL external function references and drives the final autocall process again.

The binder maps names according to the following hierarchy:

1. If the name has ever been mapped due to a pragma map in C++ code, the name is not renamed.
2. If the name has ever been mapped due to a pragma map in C code that was compiled with the LONGNAME option, the name is not renamed.
3. If a valid RENAME control statement was read for an unresolved function name, new-name specified on the applied RENAME statement is chosen, provided that old-name did not already appear on an applied RENAME statement as either a new or old name. Syntactically correct RENAME control statements that are not applied are ignored. See *z/OS MVS Program Management: User's Guide and Reference* for more information on RENAME control statements.
4. If the name corresponds to a Language Environment function, the binder may map the name according to C/C++ run-time library rules.
5. If the UPCASE(YES) option is in effect and the name is 8 bytes or less, and not otherwise renamed by any of the previous rules, the name chosen is the same name but with all alphabetic characters mapped to uppercase, and '\_' mapped to '@'. The binder maps names with the initial characters IBM, CEE, or PLI to initial characters of IB\$, CE\$, and PL\$, respectively. All names that are different only in case will map to the same name.

If renamed, the original name is replaced. The original name and the generated new name appear in the rename table of the binder listing. See "Renamed Symbol Cross Reference" on page 393.

## Generating aliases for automatic library call (library search)

For library search purposes, a member of a library (PDS, PDSE, or archive) can be an object module, a load module, or a program object. It has one member name, but may define multiple symbols (variables or functions) within it. To make library search successful, you must expose these defined symbols as aliases to the binder. When the binder searches for an unresolved reference, it can find, through the member name or an alias, the member which contains the definition. It then reads that member.

You can create aliases in the following ways:

- ALIAS binder control statement
- ALIASES(ALL) binder option
- ar utility for object module archives
- EDCALIAS utility for object module PDS and PDSEs

**Note:** Aliases that the EDCALIAS utility generates are supported only for migration purposes. Use the EDCALIAS utility only if you need to provide



autocall libraries to both prelinker and binder users. Otherwise, you should use the ALIASES(ALL) option, and bind separate compile units.

---

## Dynamic Link Library (DLL) processing

The binder supports the code that is generated by C++, and by C with the DLL compiler option, as well as code that is generated by C and C++ with the XPLINK option. Code generated with the XPLINK compiler option, like code generated by C++ and code generated by C with the DLL option, is always DLL-enabled (that is, references can be satisfied by IMPORT control statements). The binder option DYNAM(DLL) controls DLL processing. You must specify DYNAM(DLL) if the program object is to be a DLL, or if it contains DLL-type references. This section assumes that you specified the DYNAM(DLL) option. See *z/OS MVS Program Management: User's Guide and Reference* for more information on the DYNAM(DLL) binder option. You must also specify CASE(MIXED) in order to preserve the case sensitivity of symbols on IMPORT control statements.

If you are building an application that imports symbol definitions from a DLL, you must include an IMPORT control statement for each symbol to which your application expects to dynamically link. Typically, the input to your bind step for your application should include the definition side-deck of IMPORT control statements that the binder generated when the DLL was built. For compatibility, the binder accepts definition side-decks of IMPORT control statements that the Language Environment Prelinker generated. To use the definition side-decks that are distributed with IBM Class libraries, you must specify the binder option CASE(MIXED).

After final autocall processing of DD SYSLIB is complete, all DLL-type references that are not statically resolved are compared to IMPORT control statements. Symbols on IMPORT control statements are treated as definitions, and cause a matching unresolved symbol to be considered dynamically rather than statically resolved. A dynamically resolved symbol causes an entry in the binder class B\_IMPEXP to be created. If the symbol is unresolved at the end of DLL processing, it is not accessible at run time.

Addresses of statically bound symbols are known at application load time, but addresses of dynamically bound symbols are not. Instead, the run-time library that loads the DLL that exports those symbols finds their addresses at application run time. The run-time library also fixes up the linkage blocks (descriptors) for the importer in C\_WSA during program execution.

The binder builds tables of imported and exported symbols in the class B\_IMPEXP, section IEWBCIE. This element contains the necessary information about imported and exported symbols to support run-time library dynamic linking and loading.

## Statically bound functions

For each DLL-referenced function, the binder will generate a function linkage block (descriptor) of the same name as a part in the class C\_WSA.

Some of the linkage descriptors for XPLINK code are generated by the compiler rather than the binder. Compiler-generated descriptors are not visible as named entities at bind time. For XPLINK:

- Functions, which are referenced exclusively in the compilation unit, have descriptors which are generated by the compiler and have no visible names.

- Functions, which are possibly referenced outside of the compilation unit (either by function pointer, or because they are exported), have descriptors which are generated by Language Environment when the DLL is loaded. They are not part of C\_WSA. There will be a pointer to the function descriptor in C\_WSA.
- For all other DLL-referenced functions, function descriptors are generated by the binder as a part with the same name in the class C\_WSA (with the exception that for NORENT compiles, the descriptor will be in B\_DESCR rather than C\_WSA).

All C++ code and XPLINK code generate DLL references. C code generates DLL references if you used the DLL compiler option. If a DLL reference to an external function is resolved at the end of final autocall processing, the binder generates a function linkage block of the same name in the Writable Static Area, and initializes it to point to the resolved function. If the DLL reference is to a static function, the binder generates a function linkage block with a private name, which is initialized to point to the resolved static function.

## Imported variables

For each DLL-referenced external variable in C\_WSA that is unresolved at the end of final autocall processing (DD SYSLIB), if a matching IMPORT control statement was read in, the variable is considered to be resolved via dynamic linking from the DLL named on the IMPORT control statement. The binder will generate a variable linkage block (descriptor) of the same name, as a part in the class C\_WSA.

## Imported functions

For each DLL-referenced external function that is unresolved at the end of final autocall processing, if a matching IMPORT control statement was read in, the function is considered to be resolved via dynamic linking from the DLL named on the IMPORT control statement. The binder will generate a function linkage block (descriptor) of the same name, as a part in the class C\_WSA.

---

## Output program object

The DD SYSLMOD defines where the binder stores its output program object. You can store the output program object in one of the following:

- A PDSE member, where the binder stores a single program object
- A PDSE where the binder stores its output program objects (one program object for each NAME control statement)
- A z/OS UNIX System Services file or directory

The PDSE must have the attribute RECFM=U.

---

## Output IMPORT statements

The DD SYSDEFSD defines the output sequential data set where the binder writes out IMPORT control statements. The binder writes one control statement for each exported external symbol (function or variable), if you specify the option DYNAM(DLL). The data set must have the attributes RECFM=F or RECFM=FB, and LRECL=80.

You can mark symbols for export by using the **#pragma export** directive or the EXPORTALL compiler option, or the C++ `_Export` keyword.

---

## Output listing

This section contains an overview of the binder output listing. The binder creates the listing when you use the LIST binder option. It writes the listing to the data set that you defined by the DD SYSPRINT.

The listing consist of a number of categories. Some categories always appear in the listing, and others may appear depending on the options that you selected, or that were in effect.

Names that the binder generated appear as \$PRIVxxxxxx rather than \$PRIVATE. Private names that appear in the binder listing do not actually have that name in the program object. Their purpose in the listing is to permit association between various occurrences of the same private name within the listing. For purposes of rebindability, it is crucial that no sections have private names.

C++ names that appear in messages and listings are mangled names.

For the example listings in this section, the files USERID.PLAN9.OBJ(CU1) and /u/userid/plan9/cu2.o were bound together using the JCL shown in Figure 39 on page 392. Figure 38 shows the corresponding source files:

```
/* file: USERID.PLAN9.C(CU1) */
/* compile with: LONGNAME RENT EXPORTALL CSECT("cu1")*/
#include <stdio.h>
int Ax=10; /* exported */
int ALongNamedThingVVWhichIsExported=11; /* exported */
static int Az=12;
static int A1(void) {
    return Ax;
}
int ALongNamedThingFFWhichIsExported(void) { /* exported */
    return Ax;
}
int A3(void) { /* exported */
    return Ax + Az;
}
extern int b1(void); /* statically bound, defined in plan9/cu2.C */
main() {
    int i;
    i = b1() + call_a3() + call_b1_in_cu2();
    printf("now returning\n"); /* printf statically bound from SCEELKEX */
    return i;
}

/* file: cu2.C (C++ file) */
/* compile with: CSECT(PROJ9) */
extern b2(void);
extern "C" c2(void); /* imported from DLLC */
extern c3(void); /* imported from DLLC */
extern "C" int b1(void) { /* called from cu1.c */
    return b2();
}
int b2(void) {
    return c2() + c3();
}
```

Figure 38. Source files for listing example

```

//BIND1 EXEC CBCB,
//      BPARM='LIST(ALL),MAP,XREF',
//      OUTFILE='USERID.PLAN9.LOAE(HELLO1),DISP=SHR'
//INOBJ DD DISP=SHR,DSN=USERID.PLAN9.OBJ
//SYSDEFSD DD DISP=SHR,DSN=USERID.PLAN9.IMP
//SYSPRINT DD DISP=SHR,DSN=USERID.PLAN9.LISTINGS(CU1CU2R)
//SYSLIN DD *
INCLUDE INOBJ(CU1)
INCLUDE '/u/userid/plan9/cu2.o'
IMPORT CODE,DLLC,c1
IMPORT CODE,DLLC,c2
IMPORT CODE,DLLC,c3_Fv
RENAME 'call_a3' 'A3'
RENAME 'call_b1_in_cu2' 'b1'
ENTRY CEESTART
NAME CU1CU2(R)
/*

```

Figure 39. Listing example JCL

## Header

The heading always appears at the top of each page. It contains the product number, the binder version and release number, the date and the time the bind step began, and the entry point name. The heading also appears at the top of each section.

## Input Event Log

This section is a chronological log of events that took place during the input phase of binding. The binder LIST option controls its presence. See *z/OS MVS Program Management: User's Guide and Reference* for more information on the LIST option.

```

IEW2278I B352 INVOCATION PARAMETERS - AMODE=31,MAP,RENT,DYNAM=DLL,CASE=MIXED,
COMPAT=CURR,ALIASES=ALL,LIST(ALL),MAP,XREF
IEW2322I 1220 1 INCLUDE INOBJ(CU1)
IEW2308I 1112 SECTION CEESTART HAS BEEN MERGED.
IEW2308I 1112 SECTION PROJ9#CU1#C HAS BEEN MERGED.
IEW2308I 1112 SECTION ALongNamedThingVVWhichIsExported HAS BEEN MERGED.
IEW2308I 1112 SECTION Ax HAS BEEN MERGED.
IEW2308I 1112 SECTION PROJ9#CU1#S HAS BEEN MERGED.
IEW2308I 1112 SECTION CEEMAIN HAS BEEN MERGED.
IEW2308I 1112 SECTION PROJ9#CU1#T HAS BEEN MERGED.
IEW2322I 1220 2 INCLUDE '/u/userid/plan9/cu2.o'
IEW2308I 1112 SECTION PROJ9#cu2.C#C HAS BEEN MERGED.
IEW2308I 1112 SECTION PROJ9#cu2.C#S HAS BEEN MERGED.
IEW2308I 1112 SECTION PROJ9#cu2.C#T HAS BEEN MERGED.
IEW2322I 1220 3 IMPORT CODE 'DLLC' 'c1'
IEW2322I 1220 4 IMPORT CODE 'DLLC' 'c2'
IEW2322I 1220 5 IMPORT CODE 'DLLC' 'c3_Fv'
IEW2322I 1220 6 RENAME 'call_a3' 'A3'
IEW2322I 1220 7 RENAME 'call_b1_in_cu2' 'b1'
IEW2322I 1220 8 ENTRY CEESTART
IEW2322I 1220 9 NAME CU1CU2(R)
:
:

```

## Module Map

The Module Map is printed only if you specify the binder MAP option. It displays the attributes of each loadable binder class, along with the storage layout of the parts in that class.

For C/C++ programmers who use constructed reentrancy, two classes are of special interest: C\_CODE and C\_WSA. For LP64, the class names are C\_CODE64 and C\_WSA64. The C\_CODE class exists if C++ code is encountered or if C code is compiled with LONGNAME or RENT. The C\_WSA class exists if any defined writable static objects are encountered.

\*\*\* M O D U L E M A P \*\*\*

```
-----
CLASS C_CODE          LENGTH =      5E4  ATTRIBUTES = CAT,   LOAD, RMODE=ANY
-----
```

| SECTION<br>OFFSET | CLASS<br>OFFSET | NAME             | TYPE  | LENGTH | DDNAME | SOURCE<br>SEQ | MEMBER |
|-------------------|-----------------|------------------|-------|--------|--------|---------------|--------|
|                   | 0               | PROJ9#CU1#C      | CSECT | 330    | INOBJ  | 01            | CU1    |
| 0                 | 0               | PROJ9#CU1#C      | LABEL |        |        |               |        |
| D0                | D0              | ALongName-ported | LABEL |        |        |               |        |
| 190               | 190             | A3               | LABEL |        |        |               |        |
| 248               | 248             | main             | LABEL |        |        |               |        |

```
-----
CLASS C_WSA          LENGTH =      68  ATTRIBUTES = MRG, DEFER , RMODE=ANY
-----
```

| CLASS<br>OFFSET | NAME             | TYPE       | LENGTH |
|-----------------|------------------|------------|--------|
| 0               | c3()             | DESCRIPTOR | 20     |
| 20              | c2               | DESCRIPTOR | 20     |
| 40              | ALongName#000001 | PART       | 4      |
| 44              | Ax               | PART       | 4      |
| 48              | \$PRIV000011     | PART       | 18     |
| 60              | \$PRIV000014     | PART       | 8      |

### Data Set Summary

The Module Map ends with a Data Set Summary table, which associates input files with a corresponding ddname name and concatenation number.

The binder creates a dummy ddname for each unique z/OS UNIX System Services file when it processes path names from control statements. For example, on an INCLUDE control statement. The dummy ddname has the format "/nnnnnnn", where nnnnnnn is an integer assigned by binder, and appears in messages and listings in place of the z/OS UNIX file name.

\*\*\* DATA SET SUMMARY \*\*\*

| DDNAME   | CONCAT | FILE IDENTIFICATION   |
|----------|--------|-----------------------|
| /0000001 | 01     | /u/userid/plan9/cu2.o |
| INOBJ    | 01     | USERID.PLAN9.OBJ      |
| SYSLIB   | 01     | CEE.SCEELKEX          |
| SYSLIB   | 02     | CEE.SCEELKED          |
| SYSLIB   | 03     | CEE.SCEECPP           |

### Renamed Symbol Cross Reference

The Renamed Symbol Cross Reference is printed only if a name was renamed for library search purposes, and you specified the MAP binder option.

The binder normally processes symbols exactly as received. However, it may remove certain symbolic references if they are not resolved by the original name during autocall. See "Rename processing" on page 388. During renaming, the original reference is replaced. Such replacements, whether resolved or not, appear in the Rename Table.

The rename table is a listing of each generated new name and its original old name.

```

*** RENAMED SYMBOL CROSS REFERENCE ***
-----
RENAMED SYMBOL
SOURCE SYMBOL
-----

A3
    call_a3

b1
    call_b1_in_cu2

*** END OF RENAMED SYMBOL CROSS REFERENCE ***

*** E N D   O F   M O D U L E   M A P ***

```

## Cross Reference Table

The listing contains a Cross-Reference Table of the program object if you specify the XREF binder option. Each line in the table contains one address constant in the program object. The left half of the table shows the location (OFFSET) and reference type (TYPE) within a defined part (SECT/PART) where a reference occurs. The right half of the table describes the symbol being referenced.

CROSS - REFERENCE TABLE

---

TEXT CLASS = C\_CODE

| R E F E R E N C E |                   |                   |       | T A R G E T    |                   |                   |            |
|-------------------|-------------------|-------------------|-------|----------------|-------------------|-------------------|------------|
| CLASS             | SECT/PART(ABBREV) | ELEMENT<br>OFFSET | TYPE  | SYMBOL(ABBREV) | SECTION (ABBREV)  | ELEMENT<br>OFFSET | CLASS NAME |
| 68                | PROJ9#CU1#C       | 68                | Q-CON | Ax             | \$NON-RELOCATABLE | 44                | C_WSA      |
| 70                | PROJ9#CU1#C       | 70                | A-CON | CEESTART       | CEESTART          | 0                 | B_TEXT     |
| 138               | PROJ9#CU1#C       | 138               | Q-CON | Ax             | \$NON-RELOCATABLE | 44                | C_WSA      |
| 204               | PROJ9#CU1#C       | 204               | Q-CON | \$PRIV000011   | \$NON-RELOCATABLE | 48                | C_WSA      |
| 208               | PROJ9#CU1#C       | 208               | Q-CON | Ax             | \$NON-RELOCATABLE | 44                | C_WSA      |
| 2E4               | PROJ9#CU1#C       | 2E4               | Q-CON | \$PRIV000011   | \$NON-RELOCATABLE | 48                | C_WSA      |
| 2E8               | PROJ9#CU1#C       | 2E8               | V-CON | b1             | PROJ9#cu2.C#C     | 0                 | C_CODE     |
| 2EC               | PROJ9#CU1#C       | 2EC               | V-CON | A3             | PROJ9#CU1#C       | 190               | C_CODE     |
| 2F0               | PROJ9#CU1#C       | 2F0               | V-CON | b1             | PROJ9#cu2.C#C     | 0                 | C_CODE     |
| 2F4               | PROJ9#CU1#C       | 2F4               | V-CON | printf         | printf            | 0                 | B_TEXT     |
| 33C               | CEEMAIN           | 4                 | A-CON | main           | PROJ9#CU1#C       | 248               | C_CODE     |
| 340               | CEEMAIN           | 8                 | A-CON | EDCINPL        | EDCINPL           | 0                 | B_TEXT     |
| 3C8               | PROJ9#cu2.C#C     | 78                | V-CON | b2()           | PROJ9#cu2.C#C     | E0                | C_CODE     |
| 3D0               | PROJ9#cu2.C#C     | 80                | A-CON | CEESTART       | CEESTART          | 0                 | B_TEXT     |
| 4CA               | PROJ9#cu2.C#C     | 17A               | Q-CON | \$PRIV000014   | \$NON-RELOCATABLE | 60                | C_WSA      |
| 588               | PROJ9#cu2.C#C     | 238               | Q-CON | \$PRIV000014   | \$NON-RELOCATABLE | 60                | C_WSA      |
| 58C               | PROJ9#cu2.C#C     | 23C               | Q-CON | c2             | \$NON-RELOCATABLE | 20                | C_WSA      |
| 590               | PROJ9#cu2.C#C     | 240               | Q-CON | c3()           | \$NON-RELOCATABLE | 0                 | C_WSA      |

## Imported and Exported Symbols Listing

The Imported and Exported Symbols Listing is part of the Module Summary Report, and is printed before other module summary information. This section will not appear if you do not specify the DYNAM(DLL) option, or if you are not importing or exporting any symbols.

This section follows the cross-reference table in the binder map. The listing shows the imported or exported symbols, and whether they name code or data. It also shows the DLL member name for imported symbols.

Descriptors are identified as such in the listing. One of the following generates an object module that exports symbols:

- Code that is compiled with the C, C++, or COBOL EXPORTALL compiler option
- C/C++ code that contains the **#pragma export** directive
- C++ code that contains the `_Export` keyword

The listing format is shown below. All imported symbols appear first, followed by all exported symbols. Within each group, symbol names appear in alphabetical order. There are some differences between the two groups:

- The member name or z/OS UNIX System Services file name for IMPORT is derived from the IMPORT control statement.
- The member name for exports is always the same as the DLL member name and does not appear in the listing.
- Symbol and member names that are longer than 16 bytes are abbreviated in the listing, using a hyphen. If there are duplicates, they are abbreviated using a number sign and a number. The abbreviation table shows the mapping from the abbreviated names to the actual names. See “Long Symbol Abbreviation Table” on page 398.

In the example below, you can see that c2 and c3 are to be dynamically linked from a DLL named DLLC. Also, this program exports variables Ax and ALongNamedThingVVWhichIsExported, and functions A3 and ALongNamedThingFFWhichIsExported.

```

*** I M P O R T E D   A N D   E X P O R T E D   S Y M B O L S   ***

IMPORT/EXPORT      TYPE      NAME                MEMBER
-----
IMPORT             CODE      c2                  DLLC
IMPORT             CODE      c3()                DLLC

EXPORT             DATA     Ax
EXPORT             CODE      ALongName-ported
EXPORT             DATA     ALongName#000001
EXPORT             CODE      A3

*** END OF IMPORT/EXPORT ***

```

## Mangled to Demangled Symbol Cross Reference

The Mangled to Demangled Symbol Cross Reference table is similar to the rename table. It cross-references demangled C++ names in object modules with their corresponding mangled names.

**Note:** Mangling is name encoding for C++, which provides type safe linkage. Demangling is decoding of a mangled name into a human readable format.

```

*** SHORT MANGLED NAMES ***
-----
MANGLED NAME
  DE-MANGLED NAME
-----

b2__Fv
  b2()

c3__Fv
  c3()

*** END OF MANGLED TO DEMANGLED CROSS REFERENCE ***

```

The following example is for long mangled names.

```

** A B B R E V I A T I O N / D E M A N G L E D   N A M E S **

ABBR/MANGLE NAME    LONG SYMBOL

__javC1s1-ension           :=
__javC1s18_java/awt/Dimension
__$DEMANGLED$$           ==   java.awt.Dimension

__javC1s1-nuItem          :=
__javC1s17_java/awt/MenuItem
__$DEMANGLED$$           ==   java.awt.MenuItem

__jav15_j-ame()V          :=
__jav15_java/awt/Button9_buildName()V
__$DEMANGLED$$           ==   void java.awt.Button.buildName()

```

## Processing Options

The Processing Options section of the module summary lists values of the binder options that were in effect during the bind process.

```

PROCESSING OPTIONS:

ALIASSES                ALL
ALIGN2                   NO
AMODE                    31
CALL                     YES
CASE                     MIXED
COMPAT                   PM3
DCBS                     NO
DYNAM                    DLL
:
:
***END OF OPTIONS***

```

## Save Operation Summary

The Save Operation Summary for a save to a program object lists the blocks size of the target PDSE. If you specified DYNAM(DLL), and are exporting symbols, the Save Operation Summary shows the data set name or the z/OS UNIX System Services path name of the side file. For example:



SAVE OPERATION SUMMARY:

|               |                          |
|---------------|--------------------------|
| MEMBER NAME   | CU1CU2                   |
| LOAD LIBRARY  | USERID.PLAN9.LOAE        |
| PROGRAM TYPE  | PROGRAM OBJECT(FORMAT 3) |
| VOLUME SERIAL | M06001                   |
| DISPOSITION   | REPLACED                 |
| TIME OF SAVE  | 11.13.40 JUN 3, 1997     |
| SIDEFIELD     | USERID.PLAN9.IMP(CU1CU2) |

## Save Module Attributes

The Save Module Attributes section displays the attributes of the program object. These attributes are saved in the PDSE directory along with the program name, or saved in the z/OS UNIX System Services file.

SAVE MODULE ATTRIBUTES:

|                   |          |
|-------------------|----------|
| AC                | 000      |
| AMODE             | 31       |
| DC                | NO       |
| EDITABLE          | YES      |
| EXCEEDS 16MB      | NO       |
| EXECUTABLE        | YES      |
| MIGRATABLE        | NO       |
| OL                | NO       |
| OVLY              | NO       |
| PACK,PRIME        | NO,NO    |
| PAGE ALIGN        | NO       |
| REFR              | NO       |
| RENT              | YES      |
| REUS              | YES      |
| RMODE             | ANY      |
| SCTR              | NO       |
| SSI               |          |
| SYM GENERATED     | NO       |
| TEST              | NO       |
| XPLINK            | NO       |
| MODULE SIZE (HEX) | 00001360 |

## Entry Point and Alias Summary

The Entry Point and Alias Summary will show an entry type of "HIDDEN" for hidden aliases. Hidden aliases may not be visible to some system utilities, and are marked as "not executable", to prevent an unintentional load and execution. They are for autocall purposes only. If you specify the option ALIASES(ALL), the binder generates hidden aliases.

#### ENTRY POINT AND ALIAS SUMMARY:

| NAME:            | ENTRY TYPE | AMODE | C_OFFSET | CLASS NAME | STATUS     |
|------------------|------------|-------|----------|------------|------------|
| CEESTART         | MAIN_EP    | 31    | 00000000 | B_TEXT     |            |
| b1               | HIDDEN     |       | 00000350 | C_CODE     | REASSIGNED |
| b2()             | HIDDEN     |       | 00000430 | C_CODE     | REASSIGNED |
| main             | HIDDEN     |       | 00000248 | C_CODE     | REASSIGNED |
| Ax               | HIDDEN     |       | 00000044 | C_WSA      | REASSIGNED |
| ALongName-ported | HIDDEN     |       | 000000D0 | C_CODE     | REASSIGNED |
| ALongName#000001 | HIDDEN     |       | 00000040 | C_WSA      | REASSIGNED |
| A3               | HIDDEN     |       | 00000190 | C_CODE     | REASSIGNED |
| CEEMAIN          | HIDDEN     |       | 00000338 | C_CODE     | REASSIGNED |
| PROJ9#cu2.C#C    | HIDDEN     |       | 00000350 | C_CODE     | REASSIGNED |
| PROJ9#cu2.C#S    | HIDDEN     |       | 000005D8 | C_CODE     | REASSIGNED |
| PROJ9#cu2.C#T    | HIDDEN     |       | 000005E0 | C_CODE     | REASSIGNED |
| PROJ9#CU1#C      | HIDDEN     |       | 00000000 | C_CODE     | REASSIGNED |
| PROJ9#CU1#S      | HIDDEN     |       | 00000330 | C_CODE     | REASSIGNED |
| PROJ9#CU1#T      | HIDDEN     |       | 00000348 | C_CODE     | REASSIGNED |

\*\*\*\*\* END OF REPORT \*\*\*\*\*

## Long Symbol Abbreviation Table

The Long Symbol Abbreviation Table lists symbol names that do not fit in the space that is allocated to them in the listing. This is a cross reference of abbreviations to the actual name. The abbreviation table is printed for symbols greater than 16 bytes in length, if you specify the MAP(YES) and XREF(YES) binder options.

\*\*\* LONG SYMBOL ABBREVIATION TABLE \*\*\*

| ABBREVIATION | LONG SYMBOL |
|--------------|-------------|
|--------------|-------------|

|                  |                                     |
|------------------|-------------------------------------|
| ALongName-ported | := ALongNamedThingFFWhichIsExported |
| ALongName#000001 | := ALongNamedThingVVWhichIsExported |

\*\*\* END OF LONG SYMBOL ABBREV. TABLE \*\*\*

## DDname vs Pathname Cross Reference Table

This section appears only if you specified path names on control statements.

I The binder creates a dummy ddname for each unique z/OS UNIX System Services  
I file when it processes z/OS UNIX file system path names from control statements.  
For example, on an INCLUDE control statement. The dummy ddname has the  
format "/nnnnnnn", where nnnnnnn is an integer assigned by the binder. The  
I integer nnnnnnn appears in messages and listings in place of the z/OS UNIX file  
name.

I The DDname vs Pathname Cross Reference Table shows the correspondence  
between the dummy ddname and its corresponding z/OS UNIX file name. The table  
appears only if there is a generated ddname. Pathnames that you specified on JCL  
have user-assigned ddnames, and do not appear in this table. The following is the  
format of the DDname vs Pathname Cross Reference Table.

```

+++++
| D D N A M E   V S   P A T H N A M E   C R O S S   R E F E R E N C E   |
+++++

DDNAME   PATHNAME
-----
/0000001 /u/userid/plan9/cu2.o

*** END OF DDNAME VS PATHNAME ***

```

## Message Summary Report

The binder generates a Message Summary Report at the conclusion of each bind operation. The summary contains information on the types and severity of the messages that were issued during the bind process. You can search other parts of the listing to find where the messages were issued.

```

-----
MESSAGE SUMMARY REPORT
-----
SEVERE MESSAGES      (SEVERITY = 12)
NONE

ERROR MESSAGES      (SEVERITY = 08)
NONE

WARNING MESSAGES    (SEVERITY = 04)
NONE

INFORMATIONAL MESSAGES (SEVERITY = 00)
2008 2278 2308 2322

**** END OF MESSAGE SUMMARY REPORT ****

```

---

## Binder processing of C/C++ object to program object

The binder recognizes C/C++ object modules and performs special processing for them.

C/C++ categorizes reentrant programs as natural or constructed. The binder supports both natural reentrancy and C/C++ constructed reentrancy. However, programs that contain constructed reentrancy need additional run-time library for support while executing.

C code is naturally reentrant if it contains no data in the Writable Static Area. Modifiable data can be one of the following:

- External variables
- Static variables
- Writable strings
- DLL linkage blocks (descriptors) for variables
- DLL linkage blocks (descriptors) for functions

C++ code always has DLL type references for all function references that require a function descriptor in C\_WSA. This means that all C++ programs are made reentrant via constructed reentrancy.

Programs with constructed reentrancy have two areas:

- A modifiable area that contains modifiable objects, seen in the binder class C\_WSA
- A constant or reentrant area that contains executable code and constant data, seen in the binder classes B\_TEXT or C\_CODE.

Each user running the program receives a private copy of the C\_WSA demand load class, which is mapped by the binder and is loaded by the run-time library. Multiple spaces or sessions can share the second part only if it is installed in the link pack area (LPA) or extended link pack area (ELPA). You must install PDSEs dynamically in the LPA.

To generate reentrant C/C++ code, follow these steps:

1. Compile your source files to generate code with constructed reentrancy as follows:
  - Compile your C source files with the RENT compiler option to generate code with constructed reentrancy.
  - Compile your C++ source files with whatever options you require. The compiler will generate C++ code with constructed reentrancy.
2. Use the binder to combine all input object modules into a single output program object.

Each compile unit maps to a number of sections, which belong to the C\_CODE, C\_WSA, or B\_TEXT binder classes. Named binder sections may be replaced and make the code potentially rebindable. You can name your C/C++ sections with either the CSECT compiler option, or with the use of the **#pragma csect** directive. The name of a section should not be the same as one of your functions or variables, as this will cause duplicate symbols.

Each section owns one or more parts. The names of the parts are the names that resolve references. The names of functions appear as labels, which also resolve references. Some parts that are owned by a section may be unnamed. Each part belongs to a binder class.

Each externally named object in the Writable Static Area appears as a part that is owned by a section of the same name in the program object. Such parts belong to the C\_WSA binder class. The binder section that owns an object also owns the initialization information for the object in the Writable Static Area. A rebind replaces this initialization information.

The code parts belong to the binder class of C\_CODE or B\_TEXT. The code parts consist of assembly instructions, constants and literals, and potentially read only variables that are not in the Writable Static Area. The following example will produce two sections, `i` and `CODE1`:

```
#pragma code(csect,"CODE1")
int i=10;
int foo(void) { return i; }
```

- The section named `i` is in class C\_WSA, and has associated with it the initialization information to initialize `i` to 10.
- The section named `CODE1` is in class C\_CODE, and has associated with it the entry point for function `foo()` and the machine instructions for the function.

When rebound, both sections `i` and `CODE1` are replaced along with any information that is associated with them.

The names in the C\_WSA class and in the C\_CODE class are in the same namespace. A variable and a function cannot have the same name.

C++ constructor calls and destructor calls that need to be collected across compile units are collected in the class C\_@@STINIT.

DLL initialization information, which needs to be collected across compile units, is collected in the class C\_@@DLLI.

**Note:** The information in this section is applicable to GOFF object modules and is not applicable to XOBJ.

## Rebindability

If the binder processes duplicate sections, it keeps *only the first one*. This feature is particularly important when rebinding. You must include the changed parts first and the old program object second. This is how you replace the changed sections.

The binder can process each object module separately so that you only need to recompile and rebind the modules that you have modified. You do not need to recompile or include the object module for any unchanged modules.

When the binder replaces a named section, it also replaces all of its parts (named or unnamed). If a section does not have the name you desire, you can change it with the **#pragma csect** directive or with the CSECT compiler option. Unnamed parts typically come from the following:

- Unnamed modifiable static parts in C\_WSA (static variables, strings)
- Unnamed static parts in C\_CODE that may not be modifiable (static variables, strings)
- Unnamed code, static, or test part in C\_CODE

You should name all sections if you want to rebind. If a section is unnamed (has a private name) and you attempt to replace it on a rebind, the unnamed section is not replaced by the updated but corresponding unnamed section. Instead, the binder keeps both the old and new unnamed sections, causing the program module to grow in size. All references to functions that are defined by both the old section and the new section are resolved first to functions in the new section. The program may run correctly, but you will get warnings about duplicate function definitions at bind time. These duplicates will never go away on future rebinds because you cannot replace or delete unnamed sections. You will also accumulate dead code in the duplicate functions which can never be accessed. This is why it is important to name all sections if you want to rebind your code.

**Example:** Suppose that our DLL consists of two compile units, cu3.c and cu4.c, that are bound using the JCL in Figure 40 on page 402:

```
/* file: cu3.c */
/* compile with: LONGNAME RENT EXPORTALL*/
#pragma csect(code,"CODE3")
func3(void) { return 4; }
int int3 = 3;
```

```
/* file: cu4.c */
/* compile with: LONGNAME RENT EXPORTALL */
#pragma csect(code,"CODE4")
func4(void) { return 4; }
int int4 = 4;
```

```

//BIND1 EXEC CBCB,
//      BPARM='CALL,MAP,DYNAM(DLL)',
//      OUTFILE='USERID.PLAN9.LOADE,DISP=SHR'
//INOBJ DD DISP=SHR,DSN=USERID.PLAN9.OBJ
//SYSLIN DD *
INCLUDE INOBJ(CU3)
INCLUDE INOBJ(CU4)
ENTRY CEESTART
NAME BADEXE(R)
/*

```

Figure 40. JCL to bind cu3.c and cu4.c

Later, you discover that func3 is in error and should return 3. Change the source code in cu3.c and recompile. Rebind as follows:

```

//BIND1 EXEC CBCB,
//      BPARM='LIST(ALL),CALL,XREF,LET,MAP,DYNAM(DLL)',
//      OUTFILE='USERID.PLAN9.LOADE,DISP=SHR'
//INOBJ DD DISP=SHR,DSN=USERID.PLAN9.OBJ
//INPOBJ DD DISP=SHR,DSN=USERID.PLAN9.LOADE
//SYSLIN DD *
INCLUDE INOBJ(CU3)
INCLUDE SYSLMOD(BADEXE)
ENTRY CEESTART
NAME GOODEXE(R)
/*

```

The input event log in the binder listing shows:

```

IEW2322I 1220 1 INCLUDE INOBJ(CU3)
IEW2308I 1112 SECTION CODE3 HAS BEEN MERGED.
IEW2308I 1112 SECTION int3 HAS BEEN MERGED.
IEW2322I 1220 2 INCLUDE INPOBJ(BADEXE)
IEW2308I 1112 SECTION CODE4 HAS BEEN MERGED.
IEW2308I 1112 SECTION int4 HAS BEEN MERGED.
IEW2308I 1112 SECTION CEESTART HAS BEEN MERGED.
IEW2308I 1112 SECTION CEESG003 HAS BEEN MERGED.
IEW2308I 1112 SECTION CEEBETBL HAS BEEN MERGED.
IEW2308I 1112 SECTION CEEBPUBT HAS BEEN MERGED.
IEW2308I 1112 SECTION CEEBTRM HAS BEEN MERGED.
IEW2308I 1112 SECTION CEEBLLST HAS BEEN MERGED.
IEW2308I 1112 SECTION CEEBINT HAS BEEN MERGED.
IEW2308I 1112 SECTION CEETGTFN HAS BEEN MERGED.
IEW2308I 1112 SECTION CEETLOC HAS BEEN MERGED.
IEW2322I 1220 3 ENTRY CEESTART
IEW2322I 1220 4 NAME GOODEXE(R)

```

BADEXE defines sections int3, CODE3, int4, and CODE4. If the binder sees duplicate sections, it uses the first one that it reads. Since CU3 defines sections CODE3 and int3, and is included before BADEXE, both sections are replaced by the newer ones in CU3 when program object GOODEXE is created.

## DLL considerations

Any IMPORT control statements used in the original bind must also be input to the re-bind, unless the dynamic resolution information is available via an INCLUDE statement.

---

## Error recovery

This section describes common errors in binding.

## Unresolved symbols

### Inconsistent reference vs. definition types

A common error is to compile one part of the code with RENT and another with NORENT. A RENT type reference (Q-CON in the binder listing) must be resolved by a Writable Static Area definition of a PART or a DESCRIPTOR in class C\_WSA. A NORENT reference (V-CON or A-CON in the binder listing) must be resolved by CSECT or a LABEL typically in class C\_CODE or B\_TEXT.

Check the binder map to ensure that objects appear as parts in the expected classes (C\_CODE, B\_TEXT, C\_WSA ...).

### Inconsistent name usage

Another problem is the case sensitivity of the symbol names. Objects in the Writable Static Area cannot be renamed, but unresolved function references may be renamed to find a definition of a different name. See “Rename processing” on page 388. Such inconsistencies arise from inconsistent usage of the LONGNAME and NOLONGNAME compiler options, and from multi-language programs that make symbol names uppercase.

**Example:** Compile the file `main.c` with the options `LONG`, `NORENT`, and `other.c` with the options `NOLONG`, `RENT`:

```
/* file: main.c */
/* compile with LONG, NORENT */
extern int I2;
extern int func2(void);
main() {
    int i;
    i = i2 + func2();
    return i;
}
/* file: other.c */
/* compile with NOLONG,RENT */
int I2 = 2;
int func2(void) { return 2; }
```

When you bind the object modules together, the following errors will occur:

- An inconsistent use of the RENT | NORENT C compiler option causes symbol `I2` to be unresolved. The definition of `I2` from `other.c` is a writable static object because of the RENT option. But a writable static object cannot resolve the reference to `I2` from `main.c` because it is a NORENT reference. The binder messages show:

```
IEW2308I 1112 SECTION I2 HAS BEEN MERGED.
```

```
IEW2456E 9207 SYMBOL I2 UNRESOLVED.
```

- An inconsistent use of the LONG | NOLONG C compiler option causes the symbol `func2` to be unresolved. The function definition in `other.c` is in uppercase because of the NOLONG option. But the reference to `func2` from `main.c` is in lowercase because of the LONG option. The binder listing shows that `FUNC2` is a LABEL, that is a defined entry point; yet the binder messages show:

```
IEW2456E 9207 SYMBOL func2 UNRESOLVED.
```

## Significance of library search order

The order in which the libraries in SYSLIB are concatenated is significant.

**Example:** Suppose that functions `f1()` and `f4()` are resolved from SYSLIB:

```

/* file: unit0.c */
extern int f1(void); /* from member UNIT1 of library LIB1 */
extern int f4(void); /* from member UNIT2 of library LIB2 */
int main() {
    int rc1, rc4;
    rc1 = f1();
    rc4 = f4();
    if (rc1 != 1) printf("fail rc1 is %d-n", rc1);
    if (rc4 != 40) printf("fail rc1 is %d-n", rc4);
    return 0;
}

```

SYSLIB defines the libraries USERID.LIB1 with members UNIT1 and UNIT2, and USERID.LIB2 with members of the same name but different contents.

The library members are compiled from the following:

```

/* member UNIT1 of library LIB1 */
int f1(void) { return 1; }

/* member UNIT2 of library LIB1 */
int f2(void) { return 2; }

/* member UNIT1 of library LIB2 */
int f1(void) { return 10; }

/* member UNIT2 of library LIB2 */
int f2(void) { return 20; }
int f3(void) { return 30; }
int f4(void) { return f2()*2; /* 40 */ }

```

When bound with ALIASES(ALL), or when the EDCALIAS utility is used, all defined symbols are seen in a library directory as aliases that indicate the library member that contains their definition.

There are two definitions of f1(), but library search of SYSLIB for f1 searches library LIB1 first, and finds alias f1 of member UNIT1. It reads in that member, and the call to f1() returns 1. Library search of SYSLIB for f4 searches LIB1 first, and does not find a definition. It then searches LIB2, and finds alias f4 of member UNIT2 of library LIB2. So UNIT2 of library LIB2 is read in resolving not only f4, but also f2 and f3, and the call to f4() returns 40. UNIT2 of library LIB1 is not read by mistake because an alias indicates not only the member name, but also the library in which that member resides.

If the order of LIB1 and LIB2 is reversed, LIB2 is searched first, and f1() is obtained from LIB2 instead.

If changing the library search order cannot work for you, use the LIBRARY control statement. See *z/OS MVS Program Management: User's Guide and Reference* for further information on the LIBRARY control statement.

## Duplicates

If the binder processes duplicate sections, it keeps the first one and ignores subsequent ones, without giving a warning. This feature is used to replace named sections when rebinding by replacing only changed sections.

If the binder processes functions that have duplicate names, it keeps all definitions, but all references resolve to the first one. An exception is in the case of C++



template instantiation. The binder takes the first user-defined function (if any) of the same signature rather than the first compiler-generated definition via template instantiation.

**Example:** Compile the following source files `doit1.c` and `doit2.c`:

```
#include <stdio.h>
/* file: doit1.c */
int int1 = 1;
#pragma csect(code,"D01")
int func2(void) { return 2; }
int func3(void) { return 3; }
extern int func4(void);
int main() {
    int i1,i2,i3,i4;
    i1 = int1;
    i2 = func2();
    i3 = func3();
    i4 = func4();
    printf("%d %d %d %d\n",i1,i2,i3,i4);
    return 0;
}

/* file: doit2.c */
int int1 = 11;
#pragma csect(code,"D02")
int func3(void) { return 33; }
int func4(void) { return 44; }
```

Use the `LONGNAME` compiler option, and bind. The binder sections are `int1, D01` and `int1, D02`. The binder keeps one of the duplicate sections, `int1`, and does not issue a warning. But uniquely named sections contain the functions. Section `D01` contains the functions `func2` and `func3`. Section `D02` contains the functions `func3` and `func4`. The binder retains both sections `D01` and `D02`, but because both sections contain function `func3`, it issues a warning message as follows:

```
IEW2480W A711 EXTERNAL SYMBOL func3 OF TYPE LD WAS ALREADY DEFINED AS A
SYMBOL OF TYPE LD IN SECTION D01.
```

It is easier to find the object code with the duplicate if you use multiple `INCLUDE` statements rather than `DD` concatenation.

**Example:** If you use:

```
//INOBJ DD DISP=SHR,DSN=USERID.PLAN9.OBJ
//SYSLIN DD *
INCLUDE INOBJ(DOIT1)
INCLUDE INOBJ(DOIT2)
ENTRY CEESTART
/*
```

The members in the binder listing are separated logically. The messages in the binder listing are:

```

:
:
IEW2322I 1220 1 INCLUDE INOBJ(DOIT1)
IEW2308I 1112 SECTION CEESTART HAS BEEN MERGED.
IEW2308I 1112 SECTION D01 HAS BEEN MERGED.
IEW2308I 1112 SECTION int1 HAS BEEN MERGED.
IEW2308I 1112 SECTION CEEMAIN HAS BEEN MERGED.
IEW2322I 1220 2 INCLUDE INOBJ(DOIT2)
IEW2480W A711 EXTERNAL SYMBOL func3 OF TYPE LD WAS ALREADY DEFINED AS A
SYMBOL OF TYPE LD IN SECTION D01.
IEW2308I 1112 SECTION D02 HAS BEEN MERGED.

```

From the informational messages, it is clear that section D01 is from INOBJ(DOIT1), and that D02 is from INOBJ(DOIT2).

**Example:** But if you use DD concatenation as follows:

```

//INOBJ DD DISP=SHR,DSN=USERID.PLAN9.OBJ
//SYSLIN DD DISP=SHR,DSN=USERID.PLAN9.OBJ(DOIT1)
//      DD DISP=SHR,DSN=USERID.PLAN9.OBJ(DOIT2)
//      DD *
//      ENTRY CEESTART
/*
:
:

```

Now the messages are:

```

IEW2308I 1112 SECTION CEESTART HAS BEEN MERGED.
IEW2308I 1112 SECTION D01 HAS BEEN MERGED.
IEW2308I 1112 SECTION int1 HAS BEEN MERGED.
IEW2308I 1112 SECTION CEEMAIN HAS BEEN MERGED.
IEW2480W A711 EXTERNAL SYMBOL func3 OF TYPE LD WAS ALREADY DEFINED AS A
SYMBOL OF TYPE LD IN SECTION D01.
IEW2308I 1112 SECTION D02 HAS BEEN MERGED.

```

It is no longer clear which input file defines which section, and this makes tracking down duplicates to the originating compile unit more difficult.

## Duplicate functions from autocall

If a library member that is expected to contain the definition of a symbol is read, it may resolve the expected symbol. It may also resolve other symbols because the library member may define multiple functions. These unexpected definitions that are pulled in through library search may cause duplicates. Since you cannot always be sure which one of the duplicate symbols you will resolve with, you should remedy the situation that is causing the duplicate symbols.

## Hunting down references to unresolved symbols

Unresolved requests generate error or warning messages in the binder listing. If a function or variable is unresolved at the end of binder processing, it can be resolved at a later rebind.

**Example:** If you did not expect a symbol to remain unresolved, you can look at the binder listing to see which parts reference the symbol. If your DD SYSLIN has a large concatenation, the input is logically concatenated before the binder processes it. Since the compile units are not logically separated, it is hard to tell which compile unit defines the part that has the reference; for example:

```

//SYSLIN DD DISP=SHR,DSN=USERID.PLAN9.OBJ(MEM1)
//      DD DISP=SHR,DSN=USERID.PLAN9.OBJ(MEM2)
//      DD DISP=SHR,DSN=USERID.PLAN9.OBJ(MEM3)

```

**Example:** You should consider using multiple INCLUDE control statements, which will logically separate the compile units for the binder informational messages in the listing. You can then find the compile unit with the unresolved reference (similar to finding duplicate function definitions); for example:

```
//INOBJ DD DISP=SHR,DSN=USERID.PLAN9.OBJ
//SYSLIN DD *
INCLUDE INOBJ(DOIT1)
INCLUDE INOBJ(DOIT2)
ENTRY CEESTART
/*
```

## Incompatible linkage attributes

The binder will check that a statically bound symbol reference and symbol definition have compatible attributes. If a mismatch is detected, the binder will issue a diagnostic message. This attribute information is contained within the binder input files, such as object files, program objects, and load modules.

For C and C++, the default attribute is based on the XPLINK and NOXPLINK options. Individual symbols can have a different attribute than the default by using the #pragma OS\_UPSTACK, #pragma OS\_DOWNSTACK, and #pragma OS\_NOSTACK.

The attributes can also be set for assembly language. Refer to the *HLASM Language Reference*, SC26-4940 for further information.

## Non-reentrant DLL problems

If you bind a DLL with the REUS(NONE) option, each load of the DLL causes a separate load of the code area and the data area (C\_WSA). If you split a statically bound program into mutually dependent DLLs, you will probably not get the desired result. Function pointers that used to compare the same may not be the same anymore, because the multiple loads of a DLL have more than one copy of the function in memory.

The same is true for data. A separate copy of C\_WSA is loaded. So, data objects that are exported from a DLL and modified are not seen as modified by the new program that uses the DLL. You should bind all DLLs with REUS(RENT), or REUS(SERIAL) so that a new C\_WSA is loaded only once per enclave.

## Code that has been prelinked

You cannot bind code that refers to objects in the Writable Static Area and has been prelinked, and code which refers to objects in the Writable Static Area and has not been prelinked, in the same program object. This is because the z/OS prelinker and the binder use different methods to manage the Writable Static Area. The z/OS prelinker removes relocation information about objects in the Writable Static Area, making them invisible to the binder. The binder keeps relocation information and manages the Writable Static Area in the binder class C\_WSA.



---

## Chapter 11. Running a C or C++ application

This chapter gives an overview of how to run z/OS XL C/C++ programs under z/OS batch, TSO, and z/OS UNIX System Services.

z/OS Language Environment provides a common run-time environment for C, C++, COBOL, PL/I, and FORTRAN. For detailed instructions on running existing and new z/OS XL C/C++ programs under z/OS Language Environment, refer to *z/OS Language Environment Programming Guide*. *z/OS XL C/C++ Programming Guide* also describes how to run z/OS XL C/C++ programs in a CICS environment.

---

### Setting the region size for z/OS XL C/C++ applications

Prior to running your applications, ensure that you have the required region size to run the compiler and to run your application.

**Note:** The current compiler default region size is 48M, but depending on your program and the degree of optimization you are using (for example, OPT(2) and IPA), you may require significantly more space.

If your installation does not change the IBM-supplied default limits in the IEALIMIT or IEFUSI exit routine modules, different values for the region size have the following results:

| Region Size Value                   | Result  |
|-------------------------------------|---|
| 0K or 0M                            | Provides the job step with all the storage that is available below and above 16 MB. The resulting size of the region below and above 16 MB is unpredictable.  |
| $< 0M \leq \text{REGION} < 16M$     | Establishes the size of the private area below 16 MB. If the region size specified is not available below 16 MB, the job step terminates abnormally. The extended region size is the default value of 32 MB.  |
| $< 16M \leq \text{REGION} \leq 32M$ | Provides the job step all the storage available below 16 MB. The resulting size of the region below 16 MB is unpredictable. The extended region size is the default value of 32 MB.   |
| $< 32M \leq \text{REGION} < 2047M$  | Provides the job step all the storage available below 16 MB. The resulting size of the region below 16 MB is unpredictable. The extended region size is the specified value. If the region size specified is not available above 16 MB, the job step abnormally terminates. |

Assuming that you do not use your own IEFUSI exit to override this, a specification of REGION=4M provides 4 MB below 16 MB, and a default of 32 MB above 16 MB for a total of 36 MB of available virtual memory and not just 4 MB.

Specifying REGION=40M provides all available private virtual memory below 16 MB, most likely around 8 MB to 10 MB, and 40 MB above 16 MB for a total of around 48 MB. This means that a JCL change from REGION=4M to REGION=40M does not change the virtual storage available to the compiler from 4 MB to 40 MB, but rather from 36 MB to 48 MB. If the only storage use increase is above 16 MB, then the actual increase is 8 MB.

For information about using the IEFUSI installation exit to set process limits, see *z/OS UNIX System Services Planning*.

---

## Running an application under z/OS batch

You must have the Language Environment Library SCEERUN available before you try to run your application under z/OS batch.

If your application was compiled using the XPLINK compiler option you must have the Language Environment Library SCEERUN2 available before you try to run your application under z/OS batch.

If your application was bound with the DLL Class Libraries, you must supply SCLBDLL2 at run time. As of z/OS V1R2, the version of the DLL library is in CBC.SCLBDLL2. The DLL data set(s) can be in the system libraries, your JOBLIB statement, or your CBC.SCLBDLL2 statement.

The search sequence for library files is in the following order: STEPLIB, JOBLIB, LINKPACK, and LINKLIST.

## Specifying run-time options under z/OS batch

When you run a C or C++ application, you can override the default values for a set of z/OS XL C/C++ run-time options. These options affect the execution of your application, including its performance, its error-handling characteristics, and its production of debugging and tuning information.

For your application to recognize run-time options, either the EXECOPS compiler option, or the **#pragma runopts(execops)** directive must be in effect. The default compiler option is EXECOPS.

You can specify run-time options under z/OS batch as follows:

- In your JCL, in the PARM parameter of the EXEC statement. For more information, refer to “Specifying run-time options in the EXEC statement” on page 411.
- On the GPARM parameter of the cataloged procedures that are supplied by IBM. Refer to “Using cataloged procedures” on page 411.
- The **#pragma runopts** statement in your source code.
- The CEEUOPT facility that is provided by z/OS Language Environment.
- In the assembler user exit. For more information on the assembler user exit, refer to the *z/OS XL C/C++ Programming Guide*.

If EXECOPS is in effect, use a slash '/' to separate run-time options from arguments passed to the application. For example:

```
GPARM= 'STORAGE(FE,FE,FE)/PARM1,PARM2,PARM3'
```

Language Environment interprets the character string that precedes the slash as run-time options. The character string following the slash is passed to the main() function of your application as arguments. If a slash does not separate the arguments, Language Environment interprets the entire string as an argument.

If the NOEXECOPS option is in effect, none of the preceding run-time options will take effect. In fact, any arguments and options that you specify in the parameter

string (including the slash, if present) are passed as arguments to the `main()` function. For a description of run-time options see “Specifying run-time options” on page 287.

You should establish the required settings of the options for all z/OS XL C/C++ programs that you execute on a production basis. Each time the program is run, the default run-time options that were selected during z/OS XL C/C++ installation apply, unless you override them by using one of the following:

- Coding a **#pragma runopts** directive in your source
- Creating a CEEUOPT csect with the CEEXOPT macro and linking this csect into the program module.
- Specifying run-time options in the EXEC or GPARM statements

**Example:** The following example shows you how to run your program under z/OS batch. Partitioned data set member `MEDICAL.ILLNESS.LOAD(SYMP TOMS)` contains your z/OS XL C/C++ executable program. The program was compiled with the EXECOPS compiler option in effect. If you want to use the run-time option `RPTOPTS(ON)`, and to pass `TESTFUNCT` as an argument to the function, use the JCL stream as follows:

```
//JOBname JOB...
//STEP1 EXEC PGM=SYMP TOMS,PARM='RPTOPTS(ON)/TESTFUNCT'
:
:
//STEPLIB DD DSN=MEDICAL.ILLNESS.LOAD,DISP=SHR
// DD DSN=CEE.SCEERUN,DISP=SHR
```

Figure 41. Running your program under z/OS batch

## Specifying run-time options in the EXEC statement

**Example:** You can specify run-time options in the PARM parameter of the EXEC statement as follows:

```
//[stepname] EXEC PGM=program_name,
// PARM='[run-time options/][program parameters]'
```

**Example:** If you want to generate a storage report and run-time options report for the application `PROGRAM1`, specify the run-time option `RPTOPTS(ON)` as follows:

```
//G01 EXEC PGM=PROGRAM1,PARM='RPTOPTS(ON) / '
```

Note that the run-time options that are passed to the main routine are followed by a slash (/) to separate them from program parameters.

## Using cataloged procedures

You can use one of the following cataloged procedures that are supplied with the z/OS XL C/C++ compiler to run your program. Each procedure listed below includes an execution step:

For z/OS XL C programs:

|                |  |
|----------------|--|
| <b>EDCCBG</b>  | Compile, bind, and run a C program             |
| <b>EDCCLG</b>  | Compile, link, and run a C program             |
| <b>EDCCLG</b>  | Compile, pre-link, link, and run a C program   |
| <b>EDCQBG</b>  | Bind and run a 64-bit C program                |
| <b>EDCQCBG</b> | Compile, bind, and run a 64-bit C program      |
| <b>EDXCGBG</b> | Compile, bind, and execute an XPLINK C Program |

For z/OS XL C++ programs:

|              |                            |
|--------------|----------------------------|
| <b>CBCBG</b> | Bind and run a C++ program |
|--------------|----------------------------|

|                |   |
|----------------|---|
| <b>CBCCB</b>   | Compile, bind, and run a C++ program          |
| <b>CBCCLG</b>  | Compile, prelink, link, and run a C++ program |
| <b>CBCG</b>    | Run a C++ program                             |
| <b>CBCLG</b>   | Prelink, link, and run a C++ program          |
| <b>CBCQBG</b>  | Bind and run a 64-bit C++ program             |
| <b>CBCQCBG</b> | Compile, bind, and run a 64-bit C++ program   |
| <b>CBCXBG</b>  | Bind and run an XPLINK C++ program            |
| <b>CBCXCBG</b> | Compile, bind, and run an XPLINK C++ program  |
| <b>CBCXG</b>   | Run an XPLINK C++ program                     |

For more information on these cataloged procedures, see Chapter 12, “Cataloged procedures and REXX EXECs,” on page 419.

**Example:** If you are using an IBM-supplied cataloged procedure, you must specify the run-time options on the GPARM parameter of the EXEC statement. Ensure that the EXECOPS run-time option is in effect.

```
//STEP EXEC EDCCBG,INFILE='...',
//      GPARM='STACK(10K)'
```

**Example:** You can also use the GPARM parameter to pass arguments to the z/OS XL C/C++ main() function. Place the argument, preceded by a slash, after the run-time options; for example:

```
//GO EXEC EDCCBG,INFILE=...,
//      GPARM='STACK(10K)/ARGUMENT'
```

**Example:** If you want to pass an argument without specifying run-time options and EXECOPS is in effect (this is the default), precede it with a slash; for example:

```
//GO EXEC EDCCBG,...GPARM='/ARGUMENT'
//GO EXEC ,...GPARM='/z/OS UNIX System Services file:/u/mike/cloudy.C'
```

**Example:** If you want to pass parameters which contain slashes, and you are not providing run-time options, you must precede the parameters with a slash, as follows:

```
//GO EXEC EDCCBG,...GPARM='/z/OS UNIX System Services file:/u/mike/cloudy.C'
```

See also “Specifying run-time options” on page 287.

---

## Running an application under TSO

Before you run your program under TSO, you must have access to the run-time library CEE.SCEERUN. To ensure that you have access to the run-time library, do one of the following:

- If you are running under ISPF in the foreground, concatenate the libraries to ISPLLIB.
- Have your system programmer add the libraries to the LPALST or LPA.
- Have your system programmer add the libraries to the LNKLIST.
- Have your system programmer change the LOGON PROC so the libraries are added to the STEPLIB for the TSO session.
- If your application was compiled using the XPLINK compiler option, you must have the Language Environment Library SCEERUN2 available before you try to run your application under TSO.



The TSO CALL command runs a load module under TSO. If *data-set-name* is the partitioned data set member that holds the load module, the command to load and run a specified load module is:

```
CALL 'data-set-name' ['parameter-string'];
```

For example, if the load module is stored in partitioned data set member SAMPLE.CPGM.LOAD(TRICKS), and the default run-time options are in effect, run your program as follows:

```
CALL 'SAMPLE.CPGM.LOAD(TRICKS)'
```

If you specify the unqualified name of the data set, the system assumes the descriptive qualifier LOAD. If you do not specify a member name, the system assumes the name TEMPNAME.

You do not need to use the CALL command if the STEPLIB ddname includes the data set that contains your program. For example, you could call a program PROG1 with two required parameters PARM1 and PARM2 from the command line:

```
PROG1 PARM1 PARM2
```

See the appropriate manual listed in *z/OS Information Roadmap* for more information on STEPLIB.

## Specifying run-time options under TSO

You can specify run-time options in a **#pragma runopts** directive or in the *parameter-string* of the TSO CALL command. The *parameter-string* contains two fields that are separated by a slash(/), and takes the form:

```
'[run-time options/][arguments to main]'
```

The first field is passed to the program initialization routine as a run-time option list; the second field is passed to the `main()` function.

To allow your application to recognize run-time options, EXECOPS must be in effect. You can specify your additional run-time options on the command line as follows: specify the options followed by a slash (/), followed by the parameters you want to pass to the `main()` function.

For example, to run a load module that is stored in the partitioned data set member GINGER.HOURLY.LOAD(CHECK), with the run-time option RPTOPTS(ON), use the following command:

```
CALL 'GINGER.HOURLY.LOAD(CHECK)' 'RPTOPTS(ON)/'
```

If the NOEXECOPS compiler or run-time option is in effect, what you specify on the command line (including the slash, if present) is passed as arguments to the `main()` function. For a description of run-time options see “Specifying run-time options” on page 287.

If you want to pass your parameters as mixed case, you must use the ASIS run-time option. See “Passing arguments to the z/OS XL C/C++ application” for more information on passing mixed case parameters.

## Passing arguments to the z/OS XL C/C++ application

The arguments passed to `main()` are `argc` and `argv`. `argc` is an integer whose value is the number of arguments that are given when the program is run. `argv` is an array of pointers to null terminated character strings, which contain the arguments

for the program. The first argument is the name of the program being run on the TSO command line. For more information on `argc`, `argv`, and `main()` see “ARGPARSE | NOARGPARSE” on page 74 or the description in *z/OS XL C/C++ Language Reference*.

The case of the characters in `argv` depends on you invoked how your z/OS XL C/C++ program, as shown in the following table.

*Table 38. Case sensitivity of arguments under TSO*

| How the z/OS XL C/C++ program is invoked    | Example                | Case of argument   |
|---|------------------------|--|
| As TSO command                              | program args           | Mixed case (However, if you pass the arguments entirely in upper case, the argument will be changed to lower case.)    |
| By CALL command (with or without ASIS)      | CALL program args      | Lower case   |
| By CALL command with control arguments ASIS | CALL program Args ASIS | Mixed case (However, if you pass the arguments entirely in upper case, the argument will be changed to as lower case.) |
| By CALL command with control ASIS           | CALL program ARGS ASIS | The arguments will be changed to lower case following ISO C standards.   |

## Running an application under z/OS UNIX System Services

This section discusses how to run your z/OS UNIX System Services XL C/C++ application.

You must have the Language Environment Library SCEERUN available before you try to run your application under z/OS UNIX System Services. If your application was compiled using the XPLINK compiler option you must have the Language Environment Library SCEERUN2 available before you try to run your application under z/OS UNIX System Services. If your application was bound with the DLL Class Libraries, you must supply SCLBDLL2 at run time. As of z/OS V1R2, the version of the DLL library is in CBC.SCLBDLL2.

### z/OS UNIX System Services application environments

You can run your z/OS UNIX System Services XL C/C++ application programs from the following environments:

- z/OS shell
- z/OS ISPF Shell (ISHELL)
- TSO/E

To call an application program that resides in a z/OS UNIX file from the TSO/E READY prompt, you must use the BPXBATCH utility.

- z/OS batch

To run an application program that resides in a z/OS UNIX file, you must use the BPXBATCH utility with the JCL EXEC statement.

- z/OS shell through z/OS batch or TSO

By using the IBM-supplied BPXBATCH program, you can run an application program that resides in a z/OS UNIX file. You supply the name of the program as an argument to the BPXBATCH program, which invokes the shell environment. The BPXBATCH runs under the z/OS batch environment or under TSO.

## Specifying run-time options under z/OS UNIX System Services

When invoking a program from the z/OS shell, slash-separated run-time options arguments syntax is not used. All the arguments always go to the `main()` routine. Specify run-time options by using the exported environment variable `_CEE_RUNOPTS`. The run-time will only use `_CEE_RUNOPTS` if the EXECOPS option is in effect.

## Restriction on using 24-bit AMODE programs

You cannot run a 24-bit AMODE z/OS XL C/C++ application program that resides in a z/OS UNIX System Services file. Any programs you intend to run from the file system must be 31-bit or 64-bit AMODE, problem program state, PSW key 8 programs. If you plan to run a 24-bit AMODE z/OS XL C/C++ program from within an application, ensure that the executable resides in a PDS or PDSE member.

Any new z/OS UNIX XL C/C++ applications you develop should be 31-bit or 64-bit AMODE.

## Copying applications between a PDS and z/OS UNIX System Services

If you have a XL C/C++ application as a PDS member and want to place it in the z/OS UNIX file system, you can use the z/OS UNIX System Services TSO/E command `OPUTX` to copy the member into a z/OS UNIX file.

If you have a XL C/C++ application as a z/OS UNIX file and want to place it in a PDS, you can use the z/OS UNIX TSO/E command `OGETX` to copy the z/OS UNIX file into a PDS.

You can also bind directly into a data set member with the `c89` or `c++` utility by specifying a data set member name on the `-o` option, as in:

```
c89 -o"//loadlib(foo)"
```

For a description of these commands, see Chapter 20, “c89 — Compiler invocation using host environment variables,” on page 489. For examples of using these commands to copy data sets to z/OS UNIX files, see *z/OS UNIX System Services User's Guide*.

## Running a data set member from the z/OS shell

If your z/OS UNIX System Services XL C/C++ program resides in data sets and you must run the executable member from within the shell, you can pass a call to the program to TSO/E. Type the TSO/E `CALL` command with the name of the executable data set member on the shell command line and press the TSO/E function key to pass the command to TSO/E. Alternatively, you can use the `tso` command from the shell. Just precede the `CALL` with `tso` on the command line and press the ENTER key.

When the program completes, the shell session is restored.

## Running z/OS UNIX System Services applications under z/OS batch

### Using the BPXBATCH utility

Use the IBM-supplied BPXBATCH program to run a XL C/C++ application under z/OS batch from a z/OS UNIX System Services file. You can invoke the BPXBATCH utility from TSO/E, or by using JCL. The BPXBATCH utility submits a batch job and performs an initial user login to run a specified program from the shell environment.

Before you invoke BPXBATCH, you must have the appropriate authority to read from and write to z/OS UNIX files. For writing program output such as error messages, you should allocate z/OS UNIX files to stdout and stderr. Allocate the standard files using the PATH options on the TSO/E ALLOCATE command or the JCL DD statement.

For more information on the BPXBATCH program, refer to Chapter 18, “BPXBATCH utility,” on page 481.

### Invoking BPXBATCH from TSO/E

From TSO/E, you can invoke BPXBATCH several ways:

- From the TSO/E READY prompt
- From a CALL command
- From a REXX EXEC

Figure 42 shows a REXX EXEC that does the following:

1. Runs the application program /myap/base\_comp from your user ID
2. Directs output to the file /myap/std/my.out
3. Writes error messages to the file /myap/std/my.err
4. Copies the output and error data to data sets

```
/* base_comp REXX exec */
"Allocate File(STDOUT) Path('/u/myu/myap/std/my.out')
  Pathopts(OWRONLY,OCREAT,OTRUNC) Pathmode(SIRWXU) Pathdisp(DELETE,DELETE)"
"Allocate File(STDERR) Path('/u/myu/myap/std/my.err')
  Pathopts(OWRONLY,OCREAT,OTRUNC) Pathmode(SIRWXU) Pathdisp(DELETE,DELETE)"

"BPXBATCH PGM /u/myu/myap/base_comp"

"Allocate File(output1) Dataset
('MYAPPS.STD(BASEOUT)')"
"Ocopy Indd(STDOUT) Outdd(output1) Text Pathopts(OVERRIDE)"

"Allocate File(output2) Dataset('MYAPPS.STD(BASEERR)')"
"Ocopy Indd(STDERR) Outdd(output2) Text Pathopts(OVERRIDE)"
```

Figure 42. REXX EXEC to Run a Program

To invoke BPXBATCH, enter the name of the REXX EXEC from the TSO/E READY prompt. When the REXX EXEC completes, the files allocated to stdout and stderr are deleted.

### Invoking BPXBATCH using JCL

To invoke BPXBATCH using JCL, submit a job that executes an application program and allocates the standard files using DD statements. For example, to run the application program /myap/base\_comp from your user ID, direct its output to the file /myap/std/my.out, write error messages to the file /myap/std/my.err, and code the JCL statements as follows:

```
//jobname JOB ...
//stepname EXEC PGM=BPXBATCH,PARM='PGM /u/myu/myap/base_comp'
//STDOUT DD PATH='/u/myu/myap/std/my.out',
// PATHOPTS=(OWRONLY,OCREAT,OTRUNC),PATHMODE=SIRWXU
//STDERR DD PATH='/u/myu/myap/std/my.err',
// PATHOPTS=(OWRONLY,OCREAT,OTRUNC),PATHMODE=SIRWXU
```

### Submitting a non-z/OS UNIX System Services executable to run under batch

If your program requires z/OS UNIX System Services, but has been link-edited into a load module (PDS member) or bound into a non-z/OS UNIX program object (PDSE member), it can be executed in the z/OS batch environment. Use the JCL EXEC statement to submit the executable to run under the batch environment. You must have the run-time option POSIX in effect, either as **#pragma runopts(POSIX(ON))**, or as **PARM='POSIX(ON)'**.



## Chapter 12. Cataloged procedures and REXX EXECs

This appendix describes the REXX EXECs (TSO) and cataloged procedures that the z/OS XL C/C++ compiler provides in conjunction with z/OS Language Environment, to call the various z/OS XL C/C++ utilities.

When you specify a data set name without enclosing it in single quotation marks ('), your user prefix will be added to the beginning of the data set name. If you enclose the data set name in quotation marks, it is treated as a fully qualified name.

For more information on the REXX EXECs and EXECs that z/OS Language Environment provides, and on the cataloged procedures that do not contain a compile step, see *z/OS Language Environment Programming Guide*.

For a description of CXXBIND see Chapter 9, "Binding z/OS XL C/C++ programs," on page 355. For a description of CXXMOD see "Prelinking and linking under TSO" on page 574. For a list of the old syntax REXX EXECs, see "Other z/OS XL C utilities" on page 431.

| Name   | Task Description  |
|--|---|
| REXX EXECs for z/OS 31-bit C and C++               |   |
| C370LIB  | Maintain an object library under TSO  |
| CXXBIND  | Generate an executable module under TSO using the binder                        |
| CXXMOD   | Generate an executable module under TSO using the pre-link and link             |
| Cataloged procedures for z/OS XL C and z/OS XL C++ |   |
| EDCLIB   | Maintain an object library  |
| CCNPD1B  | Bind C or C++ object compiled using the IPA(PDF1) and NOXPLINK options          |
| CCNQPD1B   | Bind C or C++ object compiled using the IPA(PDF1) and LP64 options              |
| CCNXP1B  | Bind C or C++ object compiled using the IPA(PDF1) and XPLINK options            |
| REXX EXECs for z/OS XL C                           |   |
| CC   | Compile (new syntax - recommended approach)<br>Note: It applies to 31-bit only. |
| CDSECT   | Run DSECT utility   |
| CPLINK   | Interactively prelink and link a C program (31-bit only)                        |
| GENXLT   | Generate a translate table  |
| ICONV  | Run the character conversion utility  |
| LOCALEDEF  | Produce a locale object   |
| Cataloged procedures for z/OS XL C                 |   |
| EDCC   | Compile a 31-bit program  |
| EDCCB  | Compile and bind a 31-bit program   |
| EDCCBG   | Compile, bind, and run a 31-bit program   |
| EDCCL  | Compile and link-edit a 31-bit program  |

| <b>Name</b>                          | <b>Task Description</b>  |
|--------------------------------------|--|
| EDCCLG                               | Compile, link-edit, and run a 31-bit program   |
| EDCCLIB                              | Compile and maintain an object library   |
| EDCI                                 | Run IPA Link step for a 31-bit program   |
| EDCPL                                | Prelink and link-edit a 31-bit program   |
| EDCCPLG                              | Compile, prelink, link-edit, and run a 31-bit program  |
| EDCDSECT                             | Run the DSECT Conversion Utility   |
| EDCGNXL                              | Generate a translate table   |
| EDCICONV                             | Run the character conversion utility   |
| EDCLDEF                              | Produce a locale object  |
| EDCQB                                | Bind a 64-bit program  |
| EDCQBG                               | Bind and run a 64-bit program  |
| EDCQCB                               | Compile and bind a 64-bit program  |
| EDCQCBG                              | Compile, bind, and run a 64-bit program  |
| EDCXCB                               | Compile, and bind an XPLINK 31-bit program   |
| EDCXCBG                              | Compile, bind, and run an XPLINK 31-bit program  |
| EDCXI                                | Run IPA Link step for an XPLINK 31-bit or 64-bit program   |
| EDCXLDEF                             | Create z/OS XL C source from a locale, compile, and bind the XPLINK program to produce an XPLINK locale object |
| REXX EXECs for z/OS XL C++           |  |
| CXX                                  | Compile under TSO  |
| Cataloged procedures for z/OS XL C++ |  |
| CBCC                                 | Compile a 31-bit program   |
| CBCCB                                | Compile and bind a 31-bit program  |
| CBCCBG                               | Compile, bind and run a 31-bit program   |
| CBCB                                 | Bind a 31-bit program  |
| CBCBG                                | Bind and run a 31-bit program  |
| CBCCL                                | Compile, prelink and link a 31-bit program   |
| CBCCLG                               | Compile, prelink, link and run a 31-bit program  |
| CBCG                                 | Run a 31-bit program   |
| CBCI                                 | Run IPA Link step for a 31-bit program   |
| CBCL                                 | Prelink and link a 31-bit program  |
| CBCLG                                | Prelink, link and run a 31-bit program   |
| CBCQB                                | Bind a 64-bit program  |
| CBCQBG                               | Bind and run a 64-bit program  |
| CBCQCB                               | Compile and bind a 64-bit program  |
| CBCQCBG                              | Compile, bind, and run a 64-bit program  |
| CBCXB                                | Bind an XPLINK program   |
| CBCXBG                               | Bind and run an XPLINK program   |



| Name    | Task Description   |
|---------|--|
| CBCXCB  | Compile and bind an XPLINK program                       |
| CBCXCBG | Compile, bind, and run an XPLINK program                 |
| CBCXG   | Run a 31-bit or 64-bit program                           |
| CBCXI   | Run IPA Link step for an XPLINK 31-bit or 64-bit program |

---

## Tailoring cataloged procedures, REXX EXECs, and EXECs

A system programmer must modify the cataloged procedures, and REXX EXECs before they are used.

The following data sets contain the cataloged procedures and REXX EXECs that are to be modified:

- CBC.SCCNPRC
- CBC.SCCNUTL
- CEE.SCEEPROC
- CEE.SCEECLST

Most customization for REXX EXECs is in CBC.SCCNUTL(CCNCCUST) and CEE.SCEECLST(CEL4CUST).

The system programmer can make the following changes to REXX EXEC CCNCCUST by editing member CCNCCUST, which resides in data set CBC.SCCNUTL:

- Change or add more binder options by modifying BINDOPTS parameter.
- Change the prefix for Language Environment LIBPRFX from the IBM-supplied default to the high-level qualifier that you chose.
- Change the prefix for XL C/C++ Base Compiler LNGPRFX from the IBM supplied default to the high-level qualifier that you chose.
- Change the prefix for Run-Time Library Extensions CLBPRFX from the IBM-supplied default to the high-level qualifier that you chose.
- To use Japanese prelinker messages, change PLANG from EDCPMSGE to EDCPMSGK.
- Change the unit parameter TUNIT if the default SYSDA does not suit your system.
- If you need to use the old syntax of CC, change CCSYNTAX to OLD or BOTH. We also have kept the support for the old syntax for compatibility with IBM C/C++ for MVS/ESA V3R1M0. It is highly recommended to choose the new syntax, especially for customers who do not have IBM C/C++ for MVS/ESA V3R1M0 installed or who do not have any dependency on the old syntax. The new syntax allows more flexibility. Refer to the *z/OS XL C/C++ Compiler and Run-Time Migration Guide for the Application Programmer* for more information.
- (Optional) You can supply your run-time options for the compiler by modifying variable CBCRTOPT. To use Japanese compiler messages, change NATLANG(ENU) to NATLANG(JPN).
- (Optional) Specify C compiler options in the CBCCCOPT parameter.
- (Optional) Specify C++ compiler options in the CBCCXOPT parameter.

The members in the following table reside in the CBC.SCCNPRC data set.

Table 39. Customization modifications

| MEMBER   | LNGPRFX | LIBPRFX | CLBPRFX | PLANG |
|----------|---------|---------|---------|-------|
| CBCB     |         | ✓       | ✓       |       |
| CBCBG    |         | ✓       | ✓       |       |
| CBCC     | ✓       | ✓       | ✓       |       |
| CBCCB    | ✓       | ✓       | ✓       |       |
| CBCCBG   | ✓       | ✓       | ✓       |       |
| CBCCL    | ✓       | ✓       | ✓       | ✓     |
| CBCCLG   | ✓       | ✓       | ✓       | ✓     |
| CBCG     |         | ✓       | ✓       |       |
| CBCI     | ✓       | ✓       | ✓       |       |
| CBCL     |         | ✓       | ✓       | ✓     |
| CBCLG    |         | ✓       | ✓       | ✓     |
| CBCQB    |         | ✓       | ✓       |       |
| CBCQBG   |         | ✓       | ✓       |       |
| CBCQCB   | ✓       | ✓       | ✓       |       |
| CBCQCBG  | ✓       | ✓       | ✓       |       |
| CBCXB    |         | ✓       | ✓       |       |
| CBCXBG   |         | ✓       | ✓       |       |
| CBCXCB   | ✓       | ✓       | ✓       |       |
| CBCXCBG  | ✓       | ✓       | ✓       |       |
| CBCXG    |         | ✓       | ✓       |       |
| CBCXI    | ✓       | ✓       | ✓       |       |
| CCNPD1B  | ✓       | ✓       | ✓       |       |
| CCNQPD1B | ✓       | ✓       | ✓       |       |
| CCNXP1B  | ✓       | ✓       | ✓       |       |
| CXXFILT  | ✓       | ✓       |         |       |
| EDCC     | ✓       | ✓       |         |       |
| EDCCB    | ✓       | ✓       |         |       |
| EDCCBG   | ✓       | ✓       |         |       |
| EDCCL    | ✓       | ✓       |         |       |
| EDCCLG   | ✓       | ✓       |         |       |
| EDCCLIB  | ✓       | ✓       |         | ✓     |
| EDCCPLG  | ✓       | ✓       |         | ✓     |
| EDCDSECT | ✓       | ✓       |         |       |
| EDCI     | ✓       | ✓       |         |       |
| EDCQB    |         | ✓       |         |       |
| EDCQBG   |         | ✓       |         |       |
| EDCQCB   | ✓       | ✓       |         |       |
| EDCQCBG  | ✓       | ✓       |         |       |
| EDCXCB   | ✓       | ✓       |         |       |
| EDCXCBG  | ✓       | ✓       |         |       |

Table 39. Customization modifications (continued)

| MEMBER | LNGPRFX | LIBPRFX | CLBPRFX | PLANG |
|--------|---------|---------|---------|-------|
| EDCXI  | ↙       | ↙       |         |       |

The IBM-supplied cataloged procedures provide many parameters to allow each site to customize them easily. The table below describes the commonly used parameters. Use only those parameters that apply to the cataloged procedure you are using. For example, if you are only compiling (EDCC), do not specify any binder parameters.

| Parameter | Description   |
|-----------|---|
| INFILE    | For compile procedures, the input z/OS XL C/C++ source file name, PDS name of source files, or directory name of source files. For IPA Link procedures (for example, EDCL, and CBCL), the input IPA object. For prelink, link and bind procedures, the input object.<br><br>If you do not specify the input data set name, you must use JCL statements to override the appropriate SYSIN DD statement in the cataloged procedure. |
| OUTFILE   | Output module name and file characteristics. For the cataloged procedures ending in a link-edit, bind or go step, specify the name of the file where the load module is to be stored. For most other cataloged procedures, specify the name of the file where the object module is to be stored.<br><br>If you do not specify an OUTFILE name, a temporary data set will be generated.  |
| CPARM     | Compiler options: If two contradictory options are specified, the last is accepted and the first ignored.   |
| STDLIBSD  | Enables procedures that contain a bind or prelink/link step to use C128N (NOXPLINK version of the C++ Standard Library).  |
| BPARM     | Bind utility options: If two contradictory options are specified, the last is accepted and the first ignored. The set of default binder options passed on the binder invocation does not include COMPAT=CURRENT. The COMPAT option is omitted so the binder default, which is COMPAT=MIN, is used unless it is explicitly overridden by specifying it with the BPARM proc option.   |
| IPARM     | IPA Link step options: If two contradictory options are specified, the last is accepted and the first ignored.  |
| PPARM     | Prelink utility options: If two contradictory options are specified, the last is accepted and the first ignored.  |
| LPARM     | Linkage-editor options: If two contradictory options are specified, the last is accepted and the first ignored.   |
| GPARM     | Language Environment run-time (Go step) options and parameters: If two contradictory Language Environment run-time options are specified, the last is accepted and the first ignored.   |
| CRUN      | Compile step execution run-time parameters for the z/OS XL C/C++ compiler.  |
| IRUN      | IPA Link step run-time parameters: for the z/OS XL C/C++ compiler.  |
| OPARM     | Object Library Utility parameters. Required for EDCLIB.   |

| Parameter | Description  |
|-----------|--|
| OBJECT    | Object module to be added to the library. The data-set name (DSN=...) and any applicable keyword parameters (such as, DCB, DISP,) can be specified using this parameter. The default is OBJECT=DUMMY. OBJECT is required for EDCLIB if the ADD function is selected. |
| LIBRARY   | Data-set name for the library for the requested function (ADD, DEL, MAP, or DIR). An example is LIBRARY='FRED.LIB.OBJ'. LIBRARY is required for EDCLIB and EDCCLIB.  |
| MEMBER    | Member of the library to contain the object module. An example is MEMBER='MYPROG'. In z/OS XL C, MEMBER is required for EDCCLIB.   |

## Data sets used

The following table gives a cross-reference of the data sets that each job step requires, and a description of how the data set is used. Refer to the input/output section of the *z/OS XL C/C++ Programming Guide* for more information about the attributes that are used when opening different types of files.

Table 40. Cross reference of data set used and job step

| DD Statement         | COMPILE | IPALINK | BIND | PLKED<br>(Prelink) | LKED<br>(Link-Edit) | GO<br>(Run) | EDCALIAS<br>(Object<br>Library) |
|----------------------|---------|---------|------|--------------------|---------------------|-------------|---------------------------------|
| STEPLIB <sup>1</sup> | X       | X       | X    | X                  |                     | X           | X                               |
| SYSCPRT              | X       | X       |      |                    |                     |             |                                 |
| SYSIN                | X       | X       | X    | X                  | X                   |             | X                               |
| SYSLIB               | X       | X       | X    | X                  | X                   |             | X                               |
| SYSLIN               | X       | X       | X    |                    | X                   |             |                                 |
| SYSLMOD              |         |         | X    |                    | X                   |             |                                 |
| SYSMOD               |         |         |      | X                  |                     |             |                                 |
| SYSMSG5              |         |         |      | X                  |                     |             | X                               |
| SYSOUT               | X       | X       |      | X                  |                     |             | X                               |
| SYSPRINT             |         | X       |      | X                  | X                   | X           | X                               |
| SYSUTx               | X       | X       |      |                    | X (SYSUT1)          |             |                                 |
| IPACNTL              |         | X       |      |                    |                     |             |                                 |

**Note:** <sup>1</sup> Optional data sets, if the compiler is in DLPA and the run-time library is in LPA, DLPA, or ELPA. To save resources (especially in z/OS UNIX System Services), do not unnecessarily specify data sets on the STEPLIB ddname.

## Description of data sets used

The following table lists the data sets that the IBM-supplied cataloged procedures use. It describes the uses of the data set, and the attributes that it supports. You require compiler work data sets only if you specified NOMEM at compile time.

### Notes:

1. You should check the defaults at your site for SYSOUT=\*
2. The compiler does not directly deal with the SYSOUT DD statement. It uses stderr, which in turn is associated with SYSOUT. However, this is just a default

ddname, which can be changed by specifying the MSGFILE run-time option. Since the compiler does not directly deal with the DD statement associated with the stderr, it cannot provide an alternate DD statement for SYSOUT. Applications that invoke the compiler using one of the documented assembler macros can affect the DD statement that is associated with the stderr only by specifying the MSGFILE run-time option in the parameter list, but not via an alternate DD statement.

Table 41. Data set descriptions for cataloged procedures

| In Job Step | DD Statement | Description and Supported Attributes (You should check the defaults at your site for SYSOUT=*)  |
|-------------|--------------|---|
| COMPILE     | SYSIN        | For a C++, C, or IPA compilation, the input data set containing the source program.<br><br>RECFM=VS, V, VB, VBS, F, FB, FBS, or FS, LRECL≤32760. It can be a PDS.   |
| COMPILE     | SYSLIB       | For a C++, C, or IPA compilation, the data set for z/OS XL C/C++ system header files for a source program.<br><br>SYSLIB must be a PDS or PDSE (DSORG=P0) and RECFM=VS, V, VB, VBS, F, FB LRECL≤32760.<br><br>RECFM cannot be mixed.<br><br>The LRECLs for F or FB RECFM must match.<br><br>For more information on searching system header files, see “SEARCH   NOSEARCH” on page 183. |
| COMPILE     | SYSLIN       | Data set for object module.<br><br>One of the following:<br><ul style="list-style-type: none"> <li>• RECFM=F or FS</li> <li>• RECFM=FB or FBS.</li> </ul> It can be a PDS. LRECL=80   |
| COMPILE     | SYSOUT       | Data set for displaying compiler error messages.<br><br>LRECL=137, RECFM=VBA, BLKSIZE=882. (Defaults for SYSOUT=*).   |
| COMPILE     | STEPLIB      | Data set for z/OS XL C/C++ compiler and run-time library modules.<br><br>STEPLIB must be a PDS or PDSE (DSORG=P0) with RECFM=U, BLKSIZE=32760, LRECL=0.   |

Table 41. Data set descriptions for cataloged procedures (continued)

| In Job Step | DD Statement   | Description and Supported Attributes (You should check the defaults at your site for SYSOUT=*)  |
|-------------|--|---|
| COMPILE     | SYSCPRT  | Output data set for compiler listing.<br><br>LRECL>=137, RECFM=VB,VBA,<br>BLKSIZE=882 (default for SYSOUT=*)<br><br>LRECL=133, RECFM=FB,FBA,<br>BLKSIZE=133*n(where n is an integer value)                    |
| COMPILE     | SYSUT1   | Obsolete work data set.<br><br>LRECL=80 and RECFM=F or FB or FBS.   |
| COMPILE     | SYSUT5, SYSUT6, SYSUT7,<br>SYSUT8, SYSUT10, SYSUT14,<br>SYSUT16, and SYSUT17 | Work data sets.<br><br>LRECL=3200, RECFM=FB, and<br>BLKSIZE=3200*n (where n is an integer value).   |
| COMPILE     | SYSUT9   | Work data set.<br><br>LRECL=137, RECFM=VB, and<br>BLKSIZE=137*n (where n is an integer value) in z/OS XL C, or 882 in z/OS XL C++.  |
| COMPILE     | SYSUT10  | PPONLY output data set.<br><br>72≤LRECL≤32760, RECFM=VS, V, VB,<br>VBS, F, FB, FBS or FS (if not<br>pre-allocated, V is the default). It can<br>be a PDS.   |
| COMPILE     | SYSEVENT   | Events output file. Must be allocated<br>by the user.   |
| COMPILE     | TEMPINC (C++ only)   | Template instantiation file. Must be a<br>PDS or PDSE.<br><br>72≤LRECL≤32760, RECFM=VS, V, VB,<br>VBS, F or FB (default is V).  |
| COMPILE     | USERLIB  | User header files. Must be a PDS or<br>PDSE.<br><br>LRECL≤32760, and RECFM=VS, V, VB,<br>VBS, F or FB.<br><br>For more information on searching<br>user header files, see “SEARCH I<br>NOSEARCH” on page 183. |
| IPALINK     | SYSIN  | Data set containing object module for<br>the IPA Link step.<br><br>LRECL=80 and RECFM=F or FB.  |
| IPALINK     | IPACNTL  | IPA Link control file directives.<br><br>RECFM=VS, V, VB, VBS, F, FB, FBS,<br>or FS, LRECL≤32760.   |

Table 41. Data set descriptions for cataloged procedures (continued)

| In Job Step | DD Statement   | Description and Supported Attributes (You should check the defaults at your site for SYSOUT=*)  |
|-------------|--|---|
| IPALINK     | SYSLIB   | <p>IPA Link step secondary input.</p> <p>SYSLIB can be a mix of two types of libraries:</p> <ul style="list-style-type: none"> <li>Object module libraries. These can be PDSs (DSORG=P0) or PDSEs, with attributes RECFM=F or RECFM=FB, and LRECL=80.</li> <li>Load module libraries. These must be PDSs (DSORG=P0) with attributes RECFM=U and BLKSIZE≤32760.</li> </ul> <p>SYSLIB member libraries must be cataloged.</p> |
| IPALINK     | SYSLIN   | <p>Data set for generated object module.</p> <p>One of the following:</p> <ul style="list-style-type: none"> <li>RECFM=F or FS</li> <li>RECFM=FB or FBS</li> </ul>  |
| IPALINK     | SYSOUT   | <p>Data set for displaying compiler error messages.</p> <p>LRECL=137, RECFM=VBA, BLKSIZE=882. (Defaults for SYSOUT=*).</p>  |
| IPALINK     | STEPLIB  | <p>Data set for z/OS XL C/C++ compiler/run-time library modules.</p> <p>STEPLIB must be a PDS or PDSE (DSORG=P0) with RECFM=U, BLKSIZE≤32760.</p>   |
| IPALINK     | SYSCPRT  | <p>Output data set for IPA Link step listings.</p> <p>LRECL=137, RECFM=VBA, BLKSIZE=882 (default for SYSOUT=*).</p>   |
| IPALINK     | SYSUT1   | <p>Obsolete work data set.</p> <p>LRECL=80 and RECFM=F or FB or FBS.</p>  |
| IPALINK     | SYSUT5, SYSUT6, SYSUT7, SYSUT8, SYSUT10, SYSUT14, SYSUT16, and SYSUT17 | <p>Work data sets.</p> <p>LRECL=3200, RECFM=FB, and BLKSIZE=3200*n (where n is an integer value).</p>   |
| IPALINK     | SYSUT9   | <p>Work data set.</p> <p>LRECL=137, RECFM=VB, and BLKSIZE=137*n (where n is an integer value).</p>  |
| BIND        | SYSDEFSD   | <p>Output from binding a DLL (an application that exports symbols).</p> <p>LRECL=80 and RECFM=F or FB or FBS</p>  |

Table 41. Data set descriptions for cataloged procedures (continued)

| In Job Step | DD Statement | Description and Supported Attributes (You should check the defaults at your site for SYSOUT=*)   |
|-------------|--------------|--|
| BIND        | SYSIN        | Data set for additional object for the binder. It defaults to Dummy.<br><br>LRECL=80 and RECFM=F, FB or FBS.   |
| BIND        | SYSLIB       | Data set for binder automatic call libraries.  |
| BIND        | SYSLIN       | Primary input data set for the binder<br>One of the following: RECFM=F or FS<br>RECFM=FB or FBS.   |
| BIND        | SYSLMOD      | Output Program Object Library. PDSE with RECFM=U and BLKSIZE<=32760.   |
| BIND        | SYSPRINT     | Data set for listing of binder diagnostic messages.<br><br>LRECL=137, RECFM=VBA, BLKSIZE=882.<br>(Default attributes for SYSOUT=*).                  |
| PLKED       | STEPLIB      | Data set containing prelink utility modules.<br><br>STEPLIB must be a PDS or PDSE (DSORG=P0) and RECFM=U and BLKSIZE<=32760.                         |
| PLKED       | SYSDEFSD     | Output from prelinking a DLL (an application that exports symbols).<br><br>LRECL=80 and RECFM=F or FB or FBS   |
| PLKED       | SYSIN        | Data set containing object module for the prelink utility. This is the primary input data set.<br><br>LRECL=80 and RECFM=F, FB or FBS.               |
| PLKED       | SYSLIB       | Data set for automatic call libraries to be used with the prelinker.<br><br>SYSLIB must be cataloged and LRECL=80 and RECFM=F or FB or FBS. DSORG=P0 |
| PLKED       | SYSMOD       | Data set for output of the prelink utility<br><br>LRECL=80 and RECFM=F or FB or FBS.   |
| PLKED       | SYSMSG       | Data set containing prelink utility messages.<br><br>LRECL=150, RECFM=F or FB or FBS and BLKSIZE=6150.   |
| PLKED       | SYSOUT       | Data set for the prelinker map.<br><br>LRECL=80 and RECFM=F or FB or FBS   |



Table 41. Data set descriptions for cataloged procedures (continued)

| In Job Step | DD Statement | Description and Supported Attributes (You should check the defaults at your site for SYSOUT=*)  |
|-------------|--------------|---|
| PLKED       | SYSPRINT     | Data set for listing of prelink utility diagnostic messages.<br><br>LRECL=137, RECFM=VBA, BLKSIZE=882.<br>(Default attributes for SYSOUT=*).  |
| LKED        | SYSLIB       | Data set for z/OS XL C/C++ autocall library.<br><br>SYSLIB must be a PDS or PDSE and have the attributes RECFM=U and BLKSIZE≤32760.   |
| LKED        | SYSLIN       | Primary input data set for linkage editor<br><br>One of the following:<br><ul style="list-style-type: none"> <li>• RECFM=F or FS</li> <li>• RECFM=FB or FBS</li> </ul>  |
| LKED        | SYSLOAD      | Output load module library.<br><br>RECFM=U and BLKSIZE≤32760.   |
| LKED        | SYSPRINT     | Data set for listings and diagnostics produced by the linkage editor.<br><br>One of the following:<br><ul style="list-style-type: none"> <li>• LRECL=121, and RECFM=FA</li> <li>• LRECL=121, RECFM=FBA, and BLKSIZE=121*n (where n is less than or equal to 40).</li> </ul> |
| LKED        | SYSIN        | Data set for additional object for the binder. It defaults to Dummy.<br><br>LRECL=80 and RECFM=F, FB or FBS.  |
| LKED        | SYSUT1       | Work data set.<br><br>The data set attributes will be supplied by the linkage editor.   |
| GO          | STEPLIB      | Run-time libraries.<br><br>STEPLIB must be one or more PDSes or PDSEs and have the attributes RECFM=U and BLKSIZE≤32760.  |
| GO          | CEEDUMP      | Data set for error messages generated by Language Environment Dump Services. CEEDUMP must be a sequential data set and it must be allocated to SYSOUT, a terminal, or a unit record device, or a data set with the attributes RECFM=VBA, LRECL=125, and BLKSIZE=882.        |

Table 41. Data set descriptions for cataloged procedures (continued)

| In Job Step | DD Statement | Description and Supported Attributes (You should check the defaults at your site for SYSOUT=*)   |
|-------------|--------------|--|
| GO          | SYSPRINT     | Data set for listings and diagnostics from user program.<br><br>LRECL=137, RECFM=VBA, BLKSIZE=882. (default attributes for SYSOUT=*).  |
| OUTILITY    | SYSIN        | Input data set for object module to be added to the library. It can be sequential or partitioned (with a member name specified).<br><br>LREL=80, RECFM=F or FB or FBS.   |
| OUTILITY    | SYSLIB       | Library for which the member name is to be added (ADD); for which the member name is to be deleted (DEL); which is to be listed (MAP); for which the C370LIB-directory is to be built. This DD must point to a single partitioned data set. Concatenations cannot be used. Member names must not be specified.<br><br>LREL=80, RECFM=F or FB or FBS. |
| OUTILITY    | SYSOUT       | Output data set for the C370LIB-directory map. It can be sequential or partitioned (with a member name specified).<br><br>LREL=80, RECFM=F or FB or FBS.   |
| OUTILITY    | SYSMSGs      | Data set containing the input messages.<br><br>LRECL=150, RECFM=F or FB or FBS.  |
| OUTILITY    | SYSPRINT     | Data set diagnostics from the C370LIB program. The default is to SYSOUT=*.<br><br>LRECL=137, RECFM=VBA, BLKSIZE=882  |

## Examples using cataloged procedures

```

/*-----
/* Compile a Partitioned Data Set program with various options
/*-----
//EXAMPLE1 EXEC EDCC,
//      INFILE='PATRICK.TEST.PDSSRC(CPROG1)',
//      OUTFILE='PATRICK.TEST.OBJECT(CPROG1),DISP=SHR',
//      CPARM='OPT NOSEQ NOMAR LIST'
//COMPILE.USERLIB DD DSNAME=PATRICK.HDR.FILES,DISP=SHR
/*
/*-----
/* Compile a Sequential program with various options
/*-----
//EXAMPLE2 EXEC EDCC,
//      INFILE='PATRICK.TEST.SEQSRC.CPROG2',
//      OUTFILE='PATRICK.TEST.OBJECT(CPROG2),DISP=SHR',
//      CPARM='OPT SOURCE XREF FLAG(E)'
//COMPILE.USERLIB DD DSNAME=PATRICK.HDR.FILES,DISP=SHR

```

Figure 43. Example compilation for z/OS XL C using EDCC

```

/*
//CCMEM EXEC CBCC,          * Compile C++ source member
//      INFILE='MIKE.CPP(ONLYONE)',
//      OUTFILE='MIKE.SAMPLE.OBJ(ONLYONE),DISP=SHR ',
//      CPARM='OPT SOURCE SHOWINC LIST'
/*
//CCPDS EXEC CBCC,          * Compile C++ source PDS
//      INFILE='MIKE.CPP',
//      OUTFILE='MIKE.PROJECT.OBJ,DISP=SHR ',
//      CPARM='NOOPT'

```

Figure 44. Example Compilation for z/OS XL C++ Using CBCC

---

## Other z/OS XL C utilities

Starting with IBM C/C++ for MVS/ESA V3R2, several improvements were made to the REXX EXECs provided with the C/C++ compiler. The improved REXX EXECs use a different syntax, which we refer to as the *new syntax*. The *old syntax* is the syntax of the REXX EXECs prior to the C/C++ for MVS/ESA V3R2 release of the compiler. This section describes the old syntax for these REXX EXECs, which is still supported. In the following table, we indicate the corresponding updated REXX EXECs which will provide new features and greater flexibility.

| Name            | Task Description              | Substitute      |
|-----------------|-------------------------------|-----------------|
| CC (old syntax) | Compile                       | CC (new syntax) |
| CMOD            | Generate an executable module | CXXMOD          |

Figure 45. Utilities for z/OS XL C

For a description of CXXMOD, see “Prelinking and linking under TSO” on page 574.

## Using the old syntax for CC

The CC command can now be invoked using a new syntax. At installation time, your system programmer can customize the CC EXEC to accept:

- Only the old syntax (the one supported by compilers prior to C/MVS™ Version 3 Release 2)
- Only the new syntax

- Both syntaxes

The CC EXEC should be customized to accept only the new syntax. If you customize the CC EXEC to accept only the old syntax, keep in mind that it does not support z/OS UNIX System Services files. If you customize the CC EXEC to accept both the old and new syntaxes, you must invoke it using either the old syntax *or* the new syntax, but not a mixture of both. If you invoke this EXEC with the old syntax, it will not support z/OS UNIX files.

For information on the new syntax, see “Using the CC and CXX REXX EXECs” on page 302. Refer to the *z/OS Program Directory* for more information about installation and customization.

The old syntax for the CC REXX EXEC is:

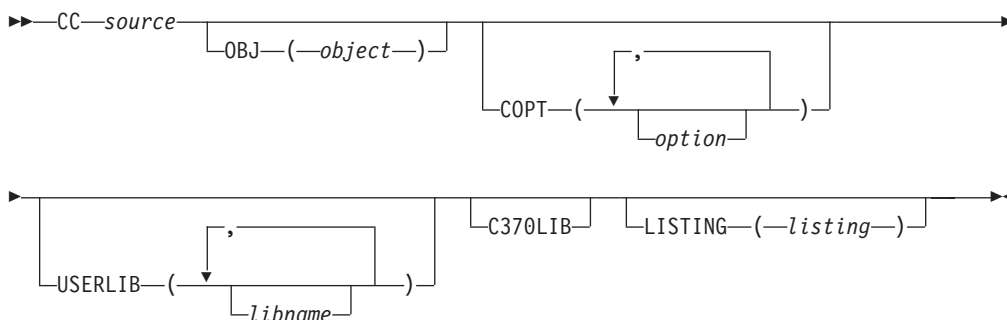

You can override the default compiler options by specifying the options:

- In the COPT keyword parameter
- In a **#pragma options** directive in your source file
- By specifying them directly on the invocation line

However, any options specified on **#pragma options** directives are overridden by options specified on the invocation line.

The following rules apply when you use the old syntax for the CC REXX EXEC:

- When you are specifying a data set name, if the name is not enclosed in single quotation mark ('), your user prefix will be added to the beginning of the data set name. If the data set name is enclosed in single quotation marks, it will be treated as a fully qualified name.
- When you need to use spaces, commas, single quotation marks, or parentheses within a REXX EXEC option, the text must be placed inside a string using single quotation marks.
- If you want to use a single quotation mark inside a string, you must use two quotation marks in place of each quotation mark.

**Example:** The following example demonstrates these rules:

```
CC TEST.C(STOCK) COPT ('SEARCH(CLOTHES.H 'MARK.SUPPLY.C(ORDER)')')
```

## Using CMOD

The CMOD REXX EXEC makes a call to LINK with the appropriate library. The syntax of the CMOD REXX EXEC is:

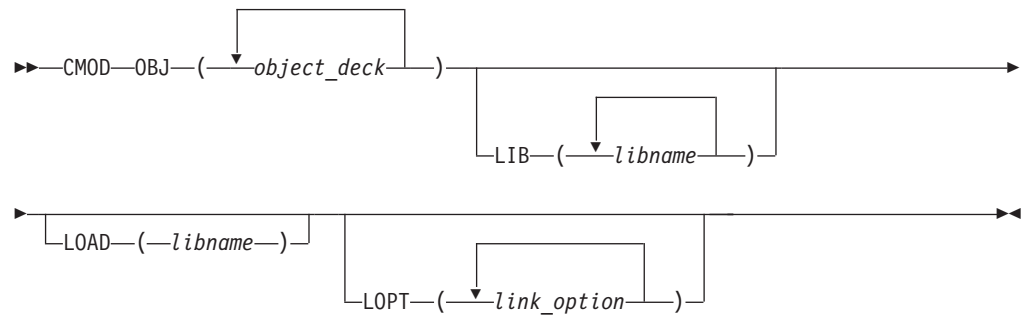

- OBJ**            Specifies the object decks that you want to link.
- LIB**            Specifies the libraries that are to be used to resolve external entries.
- LOAD**          Specifies the output library in which the load module is to be stored.
- LOPT**          Specifies the options that you want to pass to the linkage editor. All options are passed to the TSO LINK command.

A non-zero return code indicates that an error has occurred. For diagnostic information, refer to Appendix C, “Diagnosing problems,” on page 595. CMOD can also return the return code from LINK. See the appropriate document in your TSO library for more information on LINK.



---

## Part 4. Utilities and tools

This section contains information about the utilities and tools that you can use under z/OS.

- Chapter 13, “Object library utility,” on page 437
- Chapter 14, “Filter utility,” on page 449
- Chapter 15, “DSECT conversion utility,” on page 455
- Chapter 16, “Coded character set and locale utilities,” on page 469





---

## Chapter 13. Object library utility

This chapter describes how to use the object library utility to process libraries of object modules. On z/OS, a library is a PDS or PDSE with object modules as members.

*Object libraries* (also called object library utility directories) provide convenient packaging of object modules in MVS data sets, in much the same way as the z/OS UNIX System Services ar utility packages object modules that reside in z/OS UNIX files. Using the object library utility, you can create libraries that contain object modules compiled with various combinations of compiler options, such as LONGNAME | NOLONGNAME, XPLINK | NOXPLINK, IPA | NOIPA and LP64 | ILP32.

The object library utility keeps track of the attributes of each of its members in two special members of the library, which are the Basic Directory Member (@@DC370\$) and the Enhanced Directory Member (@@DC390\$). The *Basic Directory Member* is used to maintain backwards compatibility with object library utility directories that were created with older versions of the object library utility (pre-z/OS V1R2). The *Enhanced Directory Member* was introduced to support object modules that were compiled with the IPA, XPLINK, or LP64 compiler options, as well as provide more detailed listing information. If you do have older object library utility directories at your site, you should consider upgrading them to include the Enhanced Directory Member by using the DIR command (described later in this chapter).

Commands for this utility allow you to add and delete object modules from a library, rebuild the Basic and Enhanced Directory Members, and to create a listing of all the contents in an object library utility directory.

You can create an object library under z/OS batch and TSO, but not from under z/OS UNIX.

---

### Creating an object library under z/OS batch

Under z/OS batch, the following cataloged procedures include an object library utility step:

|                |   |
|----------------|---|
| <b>EDCLIB</b>  | Maintain an object library                      |
| <b>EDCCLIB</b> | Compile and maintain an object library (C only) |

For more information on the data sets that you use with the object library utility, see “Description of data sets used” on page 424.

To compile the z/OS XL C source file WALTER.SOURCE(SUB1) with the LONGNAME compiler option, and then add it to the preallocated PDS (or PDSE) data set WALTER.SOURCE.LIB, use the following JCL. If this is the first time the object library utility has been used to add an object module to WALTER.SOURCE.LIB, then the Basic and Enhanced Directory members will be created in this data set. If they already exist in this data set, then they will be updated to include the information for the object module created during the compilation.

```
//COMPILE EXEC EDCLIB,INFILE='WALTER.SOURCE(SUB1)',CPARM='LO',  
//      LIBRARY='WALTER.SOURCE.LIB',MEMBER='SUB1'
```

If you request a map for the library WALTER.SOURCE.LIB, use the following:

```
//OBJLIB EXEC EDCLIB,OPARM='MAP',LIBRARY='WALTER.SOURCE.LIB'
```

For z/OS XL C++, use the EDCLIB cataloged procedure. You can specify commands for the object library utility step on the OPARM parameter. You can specify options for the object library utility step. These options can generate a library directory, add members or delete members of a directory, or generate a map of library members and defined external symbols. This section shows you how to specify these options under z/OS batch.

**Example:** The following example creates a new object library utility directory. If the directory already exists, it is updated.

```
//DIRDIR EXEC EDCLIB,
//      LIBRARY='LUCKY13.CXX.OBJMATH',
//      OPARM='DIR'
```

**Example:** To create a listing of all the object files (members) in an object library utility directory:

```
//MAPDIR EXEC EDCLIB,
//      LIBRARY='LUCKY13.CXX.OBJMATH',
//      OPARM='MAP'
```

To add new members to an object library, use the ADD option to update the directory.

**Example:** To add a new member named MA191:

```
//ADDIR EXEC EDCLIB,
//      LIBRARY='LUCKY13.CXX.OBJMATH',
//      OPARM='ADD MA191',
//      OBJECT='DSNAME=LUCKY13.CXX.OBJ(OBJ191),DISP=SHR'
```

To delete a member from an object library, use the DEL option to keep the directory up to date.

**Example:** To delete a member named OLDMEM:

```
//DELDIR EXEC EDCLIB,
//      LIBRARY='LUCKY13.CXX.OBJMATH',
//      OPARM='DEL OLDMEM'
```

## Creating an object library under TSO

The object library utility has the following syntax:

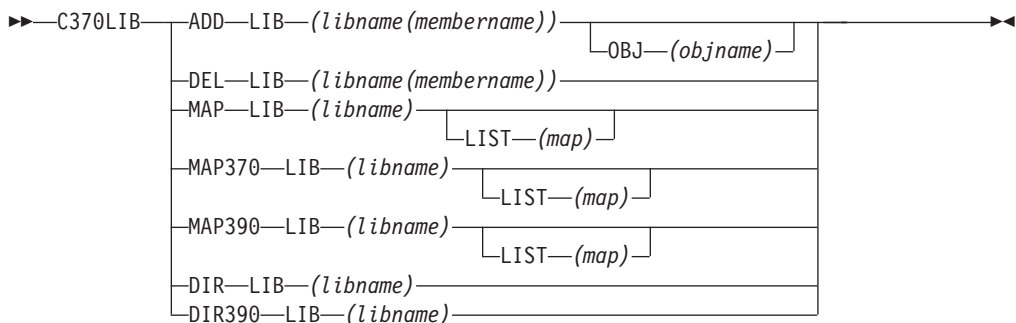

where:

### ADD

Adds (or replaces) an object module to an object library.

If you use ADD to insert an object module to a member of a library that already exists, the previous

member is deleted prior to the insert. If the source data set is the same as the target data set, ADD does not delete the member, and only updates the Object Library Utility directory.

|  |   |
|--|---|
| <b>DEL</b>                             | Deletes an object module from an object library.  |
| <b>MAP</b>                             | Lists the names (entry points) of object library members in the Enhanced Directory Member if it is available; otherwise in the Basic Directory Member. You will only see object library members that were compiled with the options IPA(NOOBJECT), XPLINK or LP64 in the listing if the Enhanced Directory Member is available.   |
| <b>MAP370</b>                          | Lists the names (entry points) of all object library members in the Basic Directory Member.   |
| <b>MAP390</b>                          | Lists the names (entry points) of all object library members in the Enhanced Directory Member.  |
| <b>DIR</b>                             | Builds the Object Library Utility directory member. The object library utility directory contains the names (entry points) of library members. The DIR function is only necessary if object modules were previously added or deleted from the library without using the object library utility.   |
| <b>DIR390</b>                          | As of z/OS V1R2, the DIR and DIR390 commands are aliases of each other, and can be used interchangeably.  |
| <b>LIB(<i>libname(membername)</i>)</b> | Specifies the target data set for the ADD and DEL functions. The data set name must contain a member specification to indicate which member Object Library Utility should create, replace, or delete.   |
| <b>OBJ(<i>objname</i>)</b>             | Specifies the source data set that contains the object module that is to be added to the library. If you do not specify a data set name, the object library utility uses the target data set that you specified in LIB( <i>libname(membername)</i> ) as the source.   |
| <b>LIB(<i>libname</i>)</b>             | Specifies the object library for which a map is to be produced or for which an object library utility directory is to be built.   |
| <b>LIST(<i>map</i>)</b>                | Specifies the data set that is to contain the object library utility listing. If you specified an asterisk (*), the listing is directed to your terminal. If you do not specify a data set name, a name is generated using the library name and the qualifier MAP. If TEST.OBJ is the input library data set, and your user prefix is FRANK, the data set name for the listing is FRANK.TEST.OBJ.MAP. |

Under TSO, for z/OS XL C you can use either the C370LIB REXX EXEC or the CC REXX EXEC with the parameter C370LIB. The C370LIB parameter of the CC REXX EXEC specifies that, if the object module from the compile is directed to a

PDS member, the object library utility directory is to be updated. This step is the equivalent to a compile and C370LIB ADD step. If the C370LIB parameter is specified, and the object module is not directed to a member of a PDS, the C370LIB parameter is ignored.

---

## Object library utility map

The object library utility produces a listing for a given library when you specify the MAP, MAP370, or MAP390 command. MAP370 displays the listing using only the information in the Basic Directory Member. It assumes that all the extended attributes are set as zero, which provides backward compatibility with earlier versions of the object library utility. MAP390 displays the listing using only the information in the Enhanced Directory Member. MAP is the preferred way of getting a listing. It generates a listing based on the Enhanced Directory Member if it's available, otherwise it generates a listing based on the Basic Directory Member. It provides additional attribute information on symbols when the information is available.

**Example:** The example that follows is produced by the object library utility for a given library when you specify the MAP or MAP390 command. The listing contains information on each member of the library.

```

=====
1                               Object Library Utility Map
C370LIB:5694A01 V1 R8 M0 IBM LANGUAGE ENVIRONMENT 2006/02/22 17:32:13
=====

```

Library Name: TS17000.DEFECT.LIB

```

-----*
* 2 Member Name:      CGOFF                               (P) 2006/02/22 16:31:11 *
*                                                            5694A01   V1 R08   *
*-----*

```

```

3
User Comment:
AGGRCOPY(NOOVERLAP) NOALIAS ANSIALIAS ARCH(5) ARGPARSE NOASCII
BITFIELD(UNSIGNED) CHARS(UNSIGNED) NOCOMPACT NOCOMPRESS NOCONVLIT
CSECT() NODEBUG NODLL(NOCALLBACKANY) EXECOPS NOEXPORTALL FLOAT(HEX,
FOLD, AFP(NOVOLATILE)) GOFF NOGONUMBER NOHGPR(NOPRESERVE) NOHOT
NOIGNERRNO ILP32 NOINITAUTO NOINLINE NOIPA LANGLVL(*EXTENDED) NOLIBANSI
NOLOCALE LONGNAME MAXMEM(2097152) NOOPTIMIZE PLIST(HOST) REDIR NORENT
NOROCONST ROSTRING NOSERVICE SPILL(128) START STRICT NOSTRICT_INDUCTION
TARGET(LE, zOSV1R8) NOTEST TUNE(5) UNROLL(AUTO) NOUPCONV NOXPLINK
COMPILED_ON_MVS

```

```

4 ( L) Function Name: @InStream@#C
  ( L) Function Name: foo
  ( WL) External Name: @InStream@#S
  ( WL) External Name: @InStream@#T
  ( WL) External Name: this_int_is_in_writable_static_and_will_wrap_b
                        ecause_it_is_too_long

```

```

-----*
* Member Name: CPPIPANO                               (P) 2006/02/22 17:32:22 *
*                                                            5694A01   V1 R02   *
*-----*

```

```

User Comment:
AGGRCOPY(NOOVERLAP) ANSIALIAS ARCH(5) ARGPARSE NOASCII
BITFIELD(UNSIGNED) CHARS(UNSIGNED) NOCOMPACT NOCOMPRESS NOCONVLIT
NOCSECT CVFT NODEBUG DLL(NOCALLBACKANY) EXECOPS NOEXPORTALL FLOAT(HEX
FOLD,AFP(NOVOLATILE)) NOGOFF NOGONUMBER NOIGNERRNO NOINITAUTO
NOINLINE(NOAUTO,NOREPORT,100,1000) IPA(NOLINK, NOOBJECT, NOOBJONLY,
OPTIMIZE, COMPRESS, NOGONUM, NOPDF1, NOPDF2, NOATTRIBUTE, NOXREF)
LANGLVL(ANONSTRUCT, ANONUNION, ANSIFOR, ANSISINIT, DBCS,
NODOLLARINAMES, EMPTYSTRUCT, ILLPTOM, IMPLICITINT, LIBEXT, LONGLONG,
NEWEXCP, OFFSETNONPOD, NOOLDDIGRAPH, OLDFRIEND, NOOLDMATH, OLDTEMPACC
NOOLDTMPLALIGN, OLDTMPLSPEC, TRAIENUM, TYPEDEFCLASS, NOUCS,
ZEROEXTARRAY) NOLIBANSI NOLOCALE LONGNAME ILP32 MAXMEM(2097152)
OBJECTMODEL(COMPAT) NOOPTIMIZE PLIST(HOST) REDIR ROCONST ROSTRING
ROUND(Z) NORTTI NOSERVICE SPILL(128) START STRICT NOSTRICT_INDUCTION
TARGET(LE, zOSV1R8) TEMPLATERECOMPILE NOTEMPLATEREGISTRY TMLPARSE(NO)
NOTEST(HOOK) TUNE(5) UNROLL(AUTO) NOXPLINK(NOBACKCHAIN,NOCALLBACK
NOGUARD,OSCALL(UPSTACK),NOSTOREARGS) NOHGPR(NOPRESERVE) NOHOT
COMPILED_ON_MVS

```

```

( I L) Function Name: myclass::myclass()
( I L) External Name: another_global
( I L) Function Name: myclass::foo(float,double)
( I L) Function Name: some_function(char)
( I L) External Name: some_global

```

```

*-----*
* Member Name: CPPNOIPA (P) 2006/02/22 17:32:28 *
* 5694A01 V1 R08 *
*-----*

```

User Comment:

```

AGGRCOPY(NOOVERLAP) ANSIALIAS ARCH(5) ARGPARSE NOASCII
BITFIELD(UNSIGNED) CHARS(UNSIGNED) NOCOMPACT NOCOMPRESS NOCONVLIT
NOCSECT CVFT NODEBUG DLL(NOCALLBACKANY) EXECOPS NOEXPORTALL FLOAT(HEX
FOLD,AFP(NOVOLATILE)) NOG OFF NOGONUMBER NOIGNERRNO NOINITAUTO
NOINLINE(NOAUTO,NOREPORT,100,1000) NOIPA LANGLVL(ANONSTRUCT, ANONUNION,
ANSIFOR, ANSISINIT, DBCS, NODOLLARINAMES, EMPTYSTRUCT, ILLPTOM,
IMPLICITINT, LIBEXT, LONGLONG, NONEWEXCP, OFFSETNONPOD, NOOLDDIGRAPH,
OLDFRIEND, NOOLDMATH, OLDTEMPACC, NOOLDTMPLALIGN, OLDTMPLSPEC,
TRAIENUM, TYPEDEFCLASS, NOUCS, ZEROEXTARRAY) NOLIBANSI NOLOCALE
LONGNAME ILP32 MAXMEM(2097152) OBJECTMODEL(COMPAT) NOOPTIMIZE
PLIST(HOST) REDIR ROCONST ROSTRING ROUND(Z) NORTTI NOSERVICE SPILL(128)
START STRICT NOSTRICT_INDUCTION TARGET(LE, zOSV1R8) TEMPLATERECOMPIL
NOTEMPLATEREGISTRY TMLPARSE(NO) NOTEST(HOOK) TUNE(5) UNROLL(AUTO)
NOXPLINK(NOBACKCHAIN,NOCALLBACK,NOGUARD,OSCALL(UPSTACK),NOSTOREARGS)
NOHGPR(NOPRESERVE) NOHOT COMPILED_ON_MVS

```

```

( L) Function Name: myclass::myclass()
( L) Function Name: myclass::foo(float,double)
( L) Function Name: some_function(char)
( WL) External Name: another_global
( WL) External Name: some_global

```

```

*-----*
* Member Name: CPPLP64 (P) 2006/02/22 16:31:31 *
* 5694A01 V1 R08 *
*-----*

```

User Comment:

```

AGGRCOPY(NOOVERLAP) ANSIALIAS ARCH(5) ARGPARSE NOASCII
BITFIELD(UNSIGNED) CHARS(UNSIGNED) NOCOMPACT NOCOMPRESS NOCONVLIT
CSECT(CODE, @InStream@#C) CSECT(STATIC, @InStream@#S) CSECT(TEST,
@InStream@#T) CVFT NODEBUG DLL(NOCALLBACKANY) EXECOPS NOEXPORTALL
FLOAT(HEX,FOLD,AFP(NOVOLATILE)) GOFF NOGONUMBER NOIGNERRNO NOINITAUTO
NOINLINE(NOAUTO,NOREPORT,100,1000) NOIPA LANGLVL(ANONSTRUCT, ANONUNION,
ANSIFOR, ANSISINIT, DBCS, NODOLLARINAMES, EMPTYSTRUCT, ILLPTOM,
IMPLICITINT, LIBEXT, LONGLONG, NONEWEXCP, OFFSETNONPOD, NOOLDDIGRAPH,
OLDFRIEND, NOOLDMATH, OLDTEMPACC, NOOLDTMPLALIGN, OLDTMPLSPEC,
TRAIENUM, TYPEDEFCLASS, NOUCS, ZEROEXTARRAY) NOLIBANSI NOLOCALE
LONGNAME LP64 MAXMEM(2097152) OBJECTMODEL(IBM) NOOPTIMIZE PLIST(HOST)
REDIR ROCONST ROSTRING ROUND(Z) NORTTI NOSERVICE SPILL(128) START
STRICT NOSTRICT_INDUCTION TARGET(LE, zOSV1R8) TEMPLATERECOMPIL
NOTEMPLATEREGISTRY TMLPARSE(NO) NOTEST(HOOK) TUNE(5) UNROLL(AUTO)
XPLINK(NOBACKCHAIN,NOCALLBACK,GUARD,OSCALL(UPSTACK),NOSTOREARGS)
NOHGPR(NOPRESERVE) NOHOT COMPILED_ON_MVS

```

```

(6 X L) Function Name: myclass::myclass()
(6 X L) Function Name: @InStream@#C
(6 X L) Function Name: myclass::foo(float,double)
(6 X L) Function Name: some_function(char)
(6 XWL) External Name: @InStream@#S
(6 XWL) External Name: @InStream@#T
(6 XWL) External Name: another_global
(6 XWL) External Name: some_global

```

```

*-----*
* Member Name:  CIPA64                      (P) 2006/02/22 17:32:43 *
*                                           5694A01   V1 R02   *
*-----*

```

```

User Comment:
AGGRCOPY(NOOVERLAP) NOALIAS ANSIALIAS ARCH(5) ARGPARSE NOASCII
BITFIELD(UNSIGNED) CHARS(UNSIGNED) NOCOMPACT NOCOMPRESS NOCONVLIT
CSECT() NODEBUG NODLL(NOCALLBACKANY) EXECOPS NOEXPORTALL FLOAT(HEX,
FOLD, AFP(NOVOLATILE)) GOFF NOGONUMBER NOHGPR(NOPRESERVE) NOHOT
NOIGNERRNO NOINITAUTO NOINLINE IPA(NOLINK, NOOBJ, COM, OPT, NOGONUM)
LANGLVL(*EXTENDED) NOLIBANSI NOLOCALE LONGNAME LP64 MAXMEM(2097152)
NOOPTIMIZE PLIST(HOST) REDIR RENT NOROCONST ROSTRING NOSERVICE
SPILL(128) START STRICT NOSTRICT_INDUCTION TARGET(LE, zOSV1R8) NOTEST
TUNE(5) UNROLL(AUTO) NOUPCONV XPLINK(NOBACKCHAIN, NOSTOREARGS,
NOCALLBACK, GUARD, OSCALL(NOSTACK)) COMPILED_ON_MVS

```

```

(6IX L) Function Name: foo
(6IX L) External Name: this_int_is_in_writable_static_and_will_wrap_b
                       ecause_it_is_too_long

```

```

=====
|                               Symbol Definition Map                               |
=====

```

```

*-----*
| 5 Symbol Name: @InStream#C |
*-----*

```

```

6 From member:  CGOFF Type: Function ( L)
From member:  CPPLP64 Type: Function (6 X L)

```

```

*-----*
| Symbol Name: this_int_is_in_writable_static_and_will_wrap_because_i |
| t_is_too_long |
*-----*

```

```

From member:  CGOFF Type: External ( WL)
From member:  CIPA64 Type: External (6IX L)

```

```

*-----*
| Symbol Name: foo |
*-----*

```

```

From member:  CGOFF Type: Function ( L)
From member:  CIPA64 Type: Function (6IX L)

```

```

*-----*
| Symbol Name: @InStream#T |
*-----*

```

```

From member:  CGOFF Type: External ( WL)
From member:  CPPLP64 Type: External (6 XWL)

```

```

*-----*
| Symbol Name: @InStream#S |
*-----*

```

```

From member:  CGOFF Type: External ( WL)
From member:  CPPLP64 Type: External (6 XWL)

```

```

*-----*
| Symbol Name: some_function(char) |
*-----*

```

```

From member: CPPNOIPA Type: Function ( L)
From member: CPPLP64 Type: Function (6 X L)
From member: CPPIPANO Type: Function ( I L)

```

```

*-----*
| Symbol Name: myclass::myclass() |
*-----*

From member: CPPNOIPA Type: Function ( L)
From member: CPPIPANO Type: Function ( I L)

*-----*
| Symbol Name: myclass::foo(float,double) |
*-----*

From member: CPPNOIPA Type: Function ( L)
From member: CPPIPANO Type: Function ( I L)

*-----*
| Symbol Name: some_global |
*-----*

From member: CPPNOIPA Type: External ( WL)
From member: CPPLP64 Type: External (6 XWL)
From member: CPPIPANO Type: External ( I L)

*-----*
| Symbol Name: another_global |
*-----*

From member: CPPNOIPA Type: External ( WL)
From member: CPPLP64 Type: External (6 XWL)
From member: CPPIPANO Type: External ( I L)

*-----*
| Symbol Name: myclass::myclass() |
*-----*

From member: CPPLP64 Type: Function (6 X L)

*-----*
| Symbol Name: myclass::foo(float,double) |
*-----*

From member: CPPLP64 Type: Function (6 X L)

===== E N D O F O B J E C T L I B R A R Y M A P =====

```

The object library utility produces a listing for a given library when the MAP370 command is specified. The listing produced by MAP370 will only contain information from the object library utility directory members that are in the XOBJ object file format. In other words, files compiled with the GOFF compiler option (which includes all XPLINK and LP64 compiled object files) will not appear in the MAP370 listing. Also, IPA(NOOBJECT) compiled files will not appear in the MAP370 listing either.



```

=====
1                               Object Library Utility Map
|C370LIB:5694A01 V1 R8 M0 IBM LANGUAGE ENVIRONMENT 2006/02/22 17:32:13|
=====

```

```

2 Library Name: TS17000.DEFECT.LIB

```

```

-----*
* 3 Member Name:      CGOFF                               (P) 2006/02/22 16:31:11 *
*-----*

```

```

-----*
* Member Name: CPPIPANO                               (P) 2006/02/22 17:32:22 *
*                               5694A01   V1 R02   *
*-----*

```

```

User Comment:
AGGRCOPY(NOOVERLAP) ANSIALIAS ARCH(5) ARGPARSE NOASCII
BITFIELD(UNSIGNED) CHARS(UNSIGNED) NOCOMPACT NOCOMPRESS NOCONVLIT
NOCSECT CVFT NODEBUG DLL(NOCALLBACKANY) EXECOPS NOEXPORTALL FLOAT(HEX
FOLD,AFP(NOVOLATILE)) NOGOFF NOGONUMBER NOIGNERRNO NOINITAUTO
NOINLINE(NOAUTO,NOREPORT,100,1000) IPA(NOLINK, NOOBJECT, NOOBJONLY,
OPTIMIZE, COMPRESS, NOGONUM, NOPDF1, NOPDF2, NOATTRIBUTE, NOXREF)
LANGLVL(ANONSTRUCT, ANONUNION, ANSIFOR, ANSISINIT, DBCS,
NODOLLARINAMES, EMPTYSTRUCT, ILLPTOM, IMPLICITINT, LIBEXT, LONGLONG,
NONEWEXCP, OFFSETNONPOD, NOOLDDIGRAPH, OLDFRIEND, NOOLDMATH, OLDTEMPACC
NOOLDTMPLALIGN, OLDTMPLSPEC, TRAILENUM, TYPEDEFCCLASS, NOUCS,
ZEROEXTARRAY) NOLIBANSI NOLOCALE LONGNAME ILP32 MAXMEM(2097152)
OBJECTMODEL(COMPAT) NOOPTIMIZE PLIST(HOST) REDIR ROCONST ROSTRING
ROUND(Z) NORTTI NOSERVICE SPILL(128) START STRICT NOSTRICT_INDUCTION
TARGET(LE, zOSV1R8) TEMPLATERECOMPILER NOTEMPLATEREGISTRY TMLPARSE(NO)
NOTEST(HOOK) TUNE(5) UNROLL(AUTO) NOXPLINK(NOBACKCHAIN, NOCALLBACK
NOGUARD, OSCALL(UPSTACK), NOSTOREARGS) NOHGPR(NOPRESERVE) NOHOT
COMPILED_ON_MVS

```

```

4 ( L) External Name: another_global
  ( L) External Name: some_global
  ( L) Function Name: myclass::myclass()
  ( L) Function Name: myclass::foo(float,double)
  ( L) Function Name: some_function(char)

```

```

-----*
* Member Name: CPPNOIPA (P) 2006/02/22 17:32:28 *
* 5694A01 V1 R08 *
-----*

```

```

User Comment:
AGGRCOPY(NOOVERLAP) ANSIALIAS ARCH(5) ARGPARSE NOASCII
BITFIELD(UNSIGNED) CHARS(UNSIGNED) NOCOMPACT NOCOMPRESS NOCONVLIT
NOCSECT CVFT NODEBUG DLL(NOCALLBACKANY) EXECOPS NOEXPORTALL FLOAT(HEX
FOLD,AFP(NOVOLATILE)) NOG OFF NOGONUMBER NOIGNERRNO NOINITAUTO
NOINLINE(NOAUTO,NOREPORT,100,1000) NOIPA LANGLVL(ANONSTRUCT, ANONUNION,
ANSIFOR, ANSISINIT, DBCS, NODOLLARINAMES, EMPTYSTRUCT, ILLPTOM,
IMPLICITINT, LIBEXT, LONGLONG, NONWEXCP, OFFSETNONPOD, NOOLDDIGRAPH,
OLDFRIEND, NOOLDMATH, OLDTEMPACC, NOOLDTMPLALIGN, OLDTMPLSPEC,
TRAILENUM, TYPEDEFCLASS, NOUCS, ZEROEXTARRAY) NOLIBANSI NOLOCALE
LONGNAME ILP32 MAXMEM(2097152) OBJECTMODEL(COMPAT) NOOPTIMIZE
PLIST(HOST) REDIR ROCONST ROSTRING ROUND(Z) NORTTI NOSERVICE SPILL(128)
START STRICT NOSTRICT INDUCTION TARGET(LE, zOSV1R8) TEMPLATERECOMPILE
NOTEMPLATEREGISTRY TMPLPARSE(NO) NOTEST(HOOK) TUNE(5) UNROLL(AUTO)
NOXPLINK(NOBACKCHAIN,NOCALLBACK,NOGUARD,OSCALL(UPSTACK),NOSTOREARGS)
NOHGPR(NOPRESERVE) NOHOT COMPILED_ON_MVS

```

```

( L) Function Name: myclass::myclass()
( L) Function Name: myclass::foo(float,double)
( L) Function Name: some_function(char)
( WL) External Name: another_global
( WL) External Name: some_global

```

```

-----*
* Member Name: CPPLP64 (P) 2006/02/22 16:31:31 *
-----*

```

```

-----*
* Member Name: CIPA64 (P) 2006/02/22 17:32:43 *
-----*

```

```

=====
| 5 Symbol Definition Map |
=====

```

```

-----*
| 6 Symbol Name: some_function(char) |
-----*

```

```

From member: CPPIPANO Type: Function ( L)
From member: CPPNOIPA Type: Function ( L)

```

```

-----*
| Symbol Name: myclass::myclass() |
-----*

From member: CPPIPANO Type: Function ( L)
From member: CPPNOIPA Type: Function ( L)

-----*
| Symbol Name: myclass::foo(float,double) |
-----*

From member: CPPIPANO Type: Function ( L)
From member: CPPNOIPA Type: Function ( L)

-----*
| Symbol Name: some_global |
-----*

From member: CPPIPANO Type: External ( L)
From member: CPPNOIPA Type: External ( WL)

-----*
| Symbol Name: another_global |
-----*

From member: CPPIPANO Type: External ( L)
From member: CPPNOIPA Type: External ( WL)

===== E N D O F O B J E C T L I B R A R Y M A P =====

```

### 1 Map Heading

The heading contains the product number, the library version and release number, and the date and the time the Object Library Utility step began. The name of the library immediately follows the heading. To the right of the library name is the start time of the last object library utility step that updated the Object Library Utility directory.

### 2 Member Heading

The name of the object module member is immediately followed by the Timestamp field presented in *yyyy/mm/dd* format. The meaning of the timestamp is enclosed in parentheses. The object library utility retains a timestamp for each member and selects the time according to the following hierarchy:

- (P) indicates that the compile timestamp is extracted from the object module.
- (D) indicates that the timestamp is based on the time that the object library utility DIR command was last issued.
- (T) indicates that the timestamp is the time that the ADD command was issued for the member.

The next line contains the ID of the processor that produced the object module. If the processor ID is not present, the Processor ID field is not listed.

### 3 User Comments

Displays any comments that were specified in the object module with the **#pragma comment** directive. It is possible to manually add such comments to the END records of an object member and have them displayed in the listing. These comments are extracted from the END record. The compile time options are stored in the same area as user comments and are displayed here as well.

#### **4 Symbol Information**

Immediately following Member Heading and user comments is a list of the defined objects that the member contains. Each symbol is prefixed by type information that is enclosed in parentheses and either External Name or Function Name. Function Name will appear, provided the object module was compiled with the LONGNAME option and the symbol is the name of a defined external function. In all other cases, External Name is displayed. The Type field gives the following additional information on each symbol:

- 6** indicates that the object was compiled with LP64
- I** indicates that the name is compiled IPA(NOOBJECT).
- L** indicates that the name is a long name. A long name is an external C++ name in an object module or an external non-C++ name in an object module produced by compiling with the LONGNAME option.
- S** indicates that the name is a short name. A short name is an external non-C++ name in an object module produced by compiling with the NOLONGNAME option. Such a name is up to 8 characters long and single case.
- W** indicates that this is a writable static object. If it is not present, then this is not a writable static object.
- X** indicates that the name was compiled with the XPLINK option.

#### **5 Symbol Definition Map**

This section of the listing has an entry for each unique symbol name that appeared in the previous half of the listing. Any duplicate symbol names that appear in the entire object library utility directory are grouped here for cross-reference purposes. This allows you to quickly determine which attributes a particular symbol name possesses within this object library utility directory.

#### **6 Symbol Source List**

Displays the object module(s) found by the given symbol. Symbol attributes (described under "Symbol Information" above) immediately follow the names of the source objects.

## Chapter 14. Filter utility

This chapter describes how to use the CXXFILT utility to convert C++ mangled names to demangled names, which are human-readable.

When z/OS XL C++ compiles one of your source files, it does not place the function and class names appearing in that file verbatim in the object file, as would occur if you were compiling a z/OS XL C program. Instead, it "mangles" them, which means it encodes your function names with their type and scoping information. This process is required to support the more advanced features of C++ such as inheritance and function overloading. Mangled names are used to ensure type-safe linking.

Use the CXXFILT utility to convert these mangled names to demangled names. The utility copies the characters from either a given file or from standard input, to standard output. It replaces all mangled names with their corresponding demangled names.

The CXXFILT utility demangles any of the following classes of mangled names when the appropriate options are specified.

### regular names

Names that appear within the context of a function name or a member variable.

**Example:** The mangled name `__1s__7ostreamFPCc` is demangled as `ostream::operator<<(const char*)`.

### class names

Includes stand-alone class names that do not appear within the context of a function name or a member variable.

**Example:** For example, the stand-alone class name `Q2_1X1Y` is demangled as `X::Y`

### special names

Special compiler-generated class objects.

**Example:** For example, the compiler-generated symbol name `__vft1X` is demangled as `X::virtual-fn-table-ptr`.

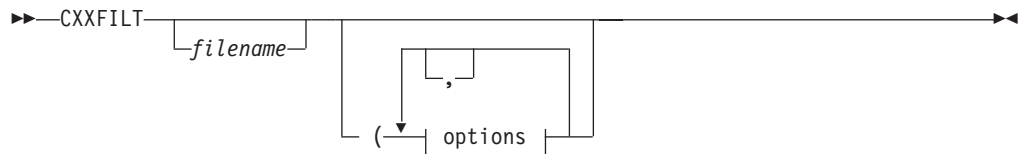

### options:

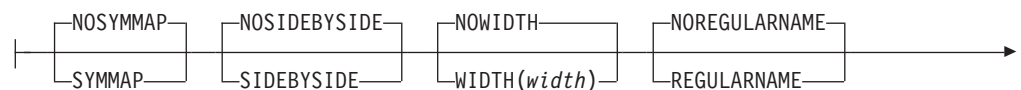

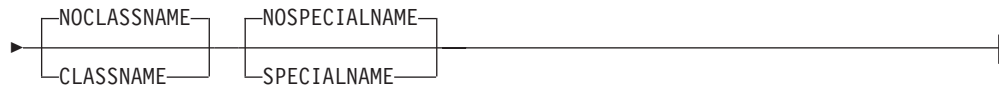

The *filename* refers to the files that contain the mangled names to be demangled. You may specify more than one file name, which can be a sequential file or a PDS member. If you do not specify a file name, CXXFILT reads its input from stdin.

The following section describes the options that you can use with the CXXFILT utility.

## CXXFILT options

You can use the following options with CXXFILT.

### SYMMAP | NOSYMMAP

Default: NOSYMMAP

Produces a symbol map on standard output. This map contains a list of the mangled names and their corresponding demangled names. The map only displays the first 40 bytes of each demangled name; it truncates the rest. Mangled names are not truncated.

If an input mangled name does not have a demangled version, the symbol mapping does not display it.

The symbol mapping is displayed after the end of the input stream is encountered, and after CXXFILT terminates.

### SIDEBYSIDE | NOSIDEBYSIDE

Default: NOSIDEBYSIDE

Each mangled name that is encountered in the input stream is displayed beside its corresponding demangled name. If you do not specify this option, then only the demangled names are printed. In either case, trailing characters in the input name that are not part of a mangled name appear next to the demangled name. For example, if an extraneous xxxx is input with the mangled name pr\_\_3F00F, then the SIDEBYSIDE option would produce this result:

```
F00::pr()      pr__3F00Fvxxxx
```

### WIDTH(width) | NOWIDTH

Default: NOWIDTH

Prints demangled names in fields, *width* characters wide. If the name is shorter than *width*, it is padded on the right with blanks; if longer, it is truncated to *width*. The value of *width* must be greater than 0. If *width* is greater than the record width, then the output is wrapped.

### REGULARNAME | NOREGULARNAME

Default: REGULARNAME

This option demangles regular names such as pr\_\_3F00Fv to F00:pr().

The mangled name that is supplied to CXXFILT is treated as a regular name by default. Specifying the NOREGULARNAME option will turn the default off. For example, specifying the CLASSNAME option without the NOREGULARNAME option will cause CXXFILT to treat the mangled name as either a regular name or stand-alone class name.

## CLASSNAME | NOCLASSNAME

Default: NOCLASSNAME

This option demangles stand-alone class names such as Q2\_1X1Y to X::Y.

To request that the mangled names be treated as stand-alone class names only, and never as a regular name, use both CLASSNAME and NOREGULARNAME.

## SPECIALNAME | NOSPECIALNAME

Default: NOSPECIALNAME

This option demangles special names, such as compiler-generated symbol names; for example, \_\_vft1X is demangled to X::virtual-fn-table-ptr.

To request that the mangled names be treated as special names only, and never as regular names, use CXXFILT (SPECIALNAME NOREGULARNAME).

## Unknown type of name

If you cannot specify the type of name, use CXXFILT (SPECIALNAME CLASSNAME). This causes CXXFILT to attempt to demangle the name in the following order:

1. Regular name
2. Stand-alone class name
3. Special name

---

## Under z/OS batch

The CXXFILT utility accepts input by two methods: from stdin or from a file.

**Example:** The following example uses the CXXFILT cataloged procedure, from data set CBC.SCBCPRC. CXXFILT reads from stdin (sysin), treats mangled names as regular names, produces a symbol mapping, and uses a field width 15 characters. The JCL follows:

```
//RUN EXEC CXXFILT,CXXPARAM='(SYMMAP WIDTH(15) '  
:  
//SYSIN DD *  
pr__3F00Fvxxxx  
__Ts__7ostreamFPcc  
__vft1X  
/*
```

The output is:

```
F00::pr()      xxxx  
ostream::operator<<(const char*)  
__vft1X
```

C++ Symbol Mapping

demangled

mangled

```

-----
F00::pr()
ostream::operator<<(const char*)

```

```

-----
pr__3F00Fv
__1s__7ostreamFPCs

```

**Notes:**

1. Because the trailing characters xxxx in the input name pr\_\_3F00Fvxxxx are not part of a valid mangled name, and the SIDEBYSIDE option is not on, the trailing characters are not demangled.

**Note:** In the symbol mappings, the trailing characters xxxx are *not* displayed.

2. The \_vft1X input is not demangled and does not appear in the symbol mapping because it is a special name, and the SPECIALNAME option was not specified.

The second method of giving input to CXXFILT is to supply it in one or more files. Fixed and variable file record formats are supported. Each line of a file can have one or more names separated by space. In the example below, mangled names are treated either as regular names or as special names (the special names are compiler-generated symbol names). Demangled names are printed in fields 35 characters wide, and output is in side-by-side format.

The output contains the following two mangled names:

```

pr__3F00Fv
__vft1X

```

You can use the following JCL:

```
//RUN EXEC CXXFILT,CXXPARAM='FILE1 (SPECIALNAME WIDTH(35) SIDEBYSIDE'
```

The CXXFILT utility terminates when it reads the end-of-file terminator.

---

## Under TSO

The CXXFILT utility accepts input by two methods: from stdin or from a file.

With the first method, enter names after invoking CXXFILT. You can specify one or more names on one or more lines. The output is displayed after you press Enter. Names that are successfully demangled, as well as those which are not demangled, are displayed in the same order as they were entered. To indicate end of input, enter /\*.

**Example:** In the following example, CXXFILT treats mangled names as regular names, produces a symbol mapping, and uses a field width 15 characters wide.

```

user> CXXFILT (SYMMAP WIDTH(15)
user> pr__3F00Fvxxxx
reply< F00::pr()      xxxx
user> __1s__7ostreamFPCc
reply> ostream::operator<<(const char*)
user> __vft1X
reply> __vft1X
user> /*

reply> C++ Symbol Mapping
reply>
reply> demangled
reply> -----
reply> F00::pr()
reply> ostream::operator<<(const char*)

mangled
-----
pr__3F00Fv
__1s__7ostreamFPCs

```



**Notes:**

1. Because the trailing characters `xxxx` in the input name `pr__3F00Fvxxxx` are not part of a valid mangled name, and the `SIDEBYSIDE` option is not on, the trailing characters are not demangled.  
In the symbol mappings, the trailing characters `xxxx` are *not* displayed.
2. The `__vft1X` input is not demangled and does not appear in the symbol mapping because it is a special name, and the `SPECIALNAME` option was not specified.
3. The symbol mapping is displayed only after `/*` requests `CXXFILT` termination

The second method of giving input to `CXXFILT` is to supply it in one or more files. `CXXFILT` supports fixed and variable file record formats. Each line of a file can have one or more names separated by space. In the example below, mangled names are treated either as regular names or as special names (the special names are compiler-generated symbol names). Demangled names are printed in fields 35 characters wide, and output is in side-by-side format.

The output contains the following two mangled names:

```
pr__3F00Fv
__vft1X
```

**Example:** Enter the following command:

```
cxxfilt FILE1 (SPECIALNAME WIDTH(35) SIDEBYSIDE
```

This will produce the output:

```
F00::pr()                pr__3F00Fv
X::virtual-fn-table-ptr  __vft1X
```

`CXXFILT` terminates when it reads the end-of-file terminator.



## Chapter 15. DSECT conversion utility

This chapter describes how to use the DSECT conversion utility, which generates a structure to map an assembler DSECT. This utility is used when a C or C++ program calls or is called by an assembler program, and a structure is required to map the area passed.

You assemble the source for the assembler DSECT by using the High Level Assembler, and specifying the ADATA option. (See *HLASM Programmer's Guide*, for a description of the ADATA option.) The DSECT utility then reads the SYSADATA file that is produced by the High Level Assembler and produces a file that contains the equivalent C structure according to the options specified.

### DSECT Utility options

The options that you can use to control the generation of the C or C++ structure are as follows. You can specify them in uppercase or lowercase, separating them by spaces or commas.

Table 42. DSECT Utility options, abbreviations, and IBM-supplied defaults

| DSECT Utility Option                | Abbreviated Name    | IBM Supplied Default    |
|-------------------------------------|---------------------|-------------------------|
| SECT[(name,...)]                    | None                | SECT(ALL)               |
| BITF0XL   NOBITF0XL                 | BITF   NOBITF       | NOBITF0XL               |
| COMMENT[(delim,...)]   NOCOMMENT    | COM   NOCOM         | COMMENT                 |
| DECIMAL   NODECIMAL                 | None                | NODECIMAL               |
| DEFSUB   NODEFSUB                   | DEF   NODEF         | DEFSUB                  |
| EQUATE[(suboptions,...)]   NOEQUATE | EQU   NOEQU         | NOEQUATE                |
| HDRSKIP[(length)]   NOHDRSKIP       | HDR(length)   NOHDR | NOHDRSKIP               |
| LOCALE(name)   NOLOCALE             | LOC   NOLOC         | NOLOCALE                |
| INDENT[(count)]   NOINDENT          | IN(count)   NOIN    | INDENT(2)               |
| LOWERCASE>   NOLOWERCASE            | LC   NOLC           | LOWERCASE>              |
| OPTFILE(filename)   NOOPTFILE       | OPTF   NOOPTF       | NOOPTFILE               |
| PPCOND[(switch)]   NOPPCOND         | PP(switch)   NOPP   | NOPPCOND                |
| SEQUENCE   NOSEQUENCE               | SEQ   NOSEQ         | NOSEQUENCE              |
| UNIQUEINUNIQUE                      | None                | NOUNIQUE                |
| UNNAME   NOUNNAMED                  | UNN   NOUNN         | NOUNNAMED               |
| OUTPUT[(filename)]                  | OUT[(filename)]     | OUTPUT<br>(DD:EDCDSECT) |
| RECFM[(rcfm)]                       | None                | C/C++ Library defaults  |
| LRECL[(lrecl)]                      | None                | C/C++ Library defaults  |
| BLKSIZE[(blksize)]                  | None                | C/C++ Library defaults  |
| LP64                                | None                | NOLP64                  |

### SECT

DEFAULT: SECT(ALL)

The SECT option specifies the section names for which structures are produced. The section names can be either CSECT or DSECT names. They must exist in the SYSADATA file that is produced by the assembler. If you do not specify the SECT option or if you specify SECT(ALL), structures are produced for all CSECTs and DSECTs defined in the SYSADATA file, except for private code and unnamed DSECTs.

If the High Level Assembler is run with the BATCH option, only the section names defined within the first program can be specified on the SECT option. If you specify SECT(ALL) (or select it by default), only the sections from the first program are selected.

## BITFOXL | NOBITFOXL

DEFAULT: NOBITFOXL

Specify the BITFOXL option when the bit fields are mapped into a flag byte as in the following example:

```
FLAGFLD DS F
          ORG FLAGFLD+0
B1FLG1  DC 0XL(B'10000000')'00'  Definition for bit 0 of 1st byte
B1FLG2  DC 0XL(B'01000000')'00'  Definition for bit 1 of 1st byte
B1FLG3  DC 0XL(B'00100000')'00'  Definition for bit 2 of 1st byte
B1FLG4  DC 0XL(B'00010000')'00'  Definition for bit 3 of 1st byte
B1FLG5  DC 0XL(B'00001000')'00'  Definition for bit 4 of 1st byte
B1FLG6  DC 0XL(B'00000100')'00'  Definition for bit 5 of 1st byte
B1FLG7  DC 0XL(B'00000010')'00'  Definition for bit 6 of 1st byte
B1FLG8  DC 0XL(B'00000001')'00'  Definition for bit 7 of 1st byte
          ORG FLAGFLD+1
B2FLG1  DC 0XL(B'10000000')'00'  Definition for bit 0 of 2nd byte
B2FLG2  DC 0XL(B'01000000')'00'  Definition for bit 1 of 2nd byte
B2FLG3  DC 0XL(B'00100000')'00'  Definition for bit 2 of 2nd byte
B2FLG4  DC 0XL(B'00010000')'00'  Definition for bit 3 of 2nd byte
```

When the bit fields are mapped as shown in the above example, you can use the following code to test the bit fields:

```
TM FLAGFLD,L'B1FLG1          Test bit 0 of byte 1
Bx label                     Branch if set/not set
```

When you specify the BITFOXL option, the length attribute of the following fields provides the mapping for the bits within the flag bytes.

The length attribute of the following fields is used to map the bit fields if a field conforms to the following rules:

- The field does not have a duplication factor of zero.
- The field has a length between 1 and 4 bytes and does not have a bit length.
- The field does not have more than one nominal value.

and the following fields conform to the following rules:

- Has a Type attribute of B, C, or X.
- Has the same offset as the field (or consecutive fields have overlapping offsets).
- Has a duplication factor of zero.
- Does not have more than one nominal value.
- Has a length attribute between 1 and 255 and does not have a bit length.
- The length attribute maps one bit or consecutive bits; for example, B'10000000' or B'11000000', but not B'10100000'.

The fields must be on consecutive lines and must overlap a named field. If the fields above are used to define the bits for a field, EQU statements that follow the field are not used to define the bit fields.

## COMMENT | NOCOMMENT

DEFAULT: COMMENT

The COMMENT option specifies whether the comments on the line where the field is defined will be placed in the structure produced.

If you specify the COMMENT option without a delimiter, the entire comment is placed in the structure.

If you specify a delimiter, any comments that follow the delimiter are skipped and are not placed in the structure. You can remove changes that are flagged with a particular delimiter. The delimiter cannot contain imbedded spaces or commas. The case of the delimiter and the comment text is not significant. You can specify up to 10 delimiters, and they can contain up to 10 characters each.

## DECIMAL | NODECIMAL

DEFAULT: NODECIMAL

The DECIMAL option will instruct the DSECT utility to convert all SYSADATA DC/DS records of type P to the function type macro: `_dec__var(w,0)`. `w` is the number of digits and it is computed by taking the byte size of the P-type data, multiplying it by two, and subtracting one from the result [in other words,  $(\text{byte\_size} * 2) - 1$ ]. The byte size of the P type data is found in the SYSADATA DC/DS record. If a SYSADATA DC/DS record of type P is interpreted to be part of a union then the DSECT utility will map it to the function type macro: `_dec__uvar(w,0)`. `w` still represents the number of digits. The `_dec__uvar` macro will expand to a decimal datatype for C and a unsigned character array for C++. This is necessary because decimal support in C++ is implemented by a decimal class. C++ does not allow a class with constructors, or destructors, to be part of a union, hence in the case of C++ such decimal data must be mapped to a character array of the same byte size.

The precision will always be left as zero since there is no way to figure out its value from the DC/DS SYSADATA record. The zero will be output, rather than just the digit size (that is, `_dec__var(w,0)` rather than just `_dec__var(w,)`), to allow you to easily edit the DSECT utility output and adjust for the desired precision. Do not remove the zero as it will cause compilation errors because the function type macros can no longer be expanded.

If the DECIMAL option is enabled and P type records are found, then the utility will also include the following code at the beginning of the output file:

```
#ifndef __decimal_found
#define __decimal_found
#ifdef __cplusplus
#define _dec__var(w,p) decimal<n>
#define _dec__uvar(w,p) _decchar##w
#include <idecimal.hpp>
typedef char _decchar1[1];
typedef char _decchar2[2];
typedef char _decchar3[2];
typedef char _decchar4[3];
typedef char _decchar5[3];
typedef char _decchar6[4];
typedef char _decchar7[4];
typedef char _decchar8[5];
typedef char _decchar9[5];
typedef char _decchar10[6];
```

```

        typedef char _decchar11[6];
        typedef char _decchar12[7];
        typedef char _decchar13[7];
        typedef char _decchar14[8];
        typedef char _decchar15[8];
        typedef char _decchar16[9];
        typedef char _decchar17[9];
        typedef char _decchar18[10];
        typedef char _decchar19[10];
        typedef char _decchar20[[11]];
        typedef char _decchar21[11];
        typedef char _decchar22[12];
        typedef char _decchar23[12];
        typedef char _decchar24[13];
        typedef char _decchar25[13];
        typedef char _decchar26[14];
        typedef char _decchar27[14];
        typedef char _decchar28[15];
        typedef char _decchar29[15];
        typedef char _decchar30[16];
        typedef char _decchar31[16];
    #else
        #define _dec_var(w,p) decimal(n,p)
        #define _dec_uvar(w,p) decimal(w,p)
        #include <decimal.h>
    #endif
#endif

```

This code will force the inclusion of the necessary header files, depending on whether the C or C++ compiler is used. It will also force the **\_dec\_var** and **\_dec\_uvar** types, which are outputted by the DSECT utility, to be mapped to the appropriate C or C++ decimal type. The definition of the macro **\_\_decimal\_found** is used to guard against the redefinition of macros if several DSECT utility output files are compiled together.

If the default NODECIMAL option is used then the DSECT utility will convert all P type DC/DS SYSATADA records to character arrays of the same byte size as the P type data, as is the existing behavior; for example, 171 (a value of PL3) will map to an unsigned char[3].

## DEFSUB | NODEFSUB

DEFAULT: DEFSUB

The DEFSUB option specifies whether #define directives will be built for fields that are part of a union or substructure.

**Example:** If the DEFSUB option is in effect, fields within a substructure or union have the field names prefixed by an underscore. A #define directive is written at the end of the structure to allow the field name to be specified directly as in the following example.

```

struct dsect_name {
    int field1;
    struct {
        int _subfld1;
        short int _subfld2;
        unsigned char _subfld3[4];
    } field2;
}
#define subfld1 field2._subfld1
#define subfld2 field2._subfld2
#define subfld3 field2._subfld3

```

If the DEFSUB option is in effect, the fields that are prefixed by an underscore may match the name of another field within the structure. No warning is issued.

## EQUATE | NOEQUATE

DEFAULT: NOEQUATE

The EQUATE option specifies whether the EQU statements following a field are to be used to define bit fields, to generate #define directives, or are to be ignored.

The suboptions specify how the EQU statement is used. You can specify one or more of the suboptions, separating them by spaces or commas. If you specify more than one suboption, the EQU statements that follow a field are checked to see if they are valid for the first suboption. If so, they are formatted according to that option. Otherwise, the subsequent suboptions are checked to see if they are applicable.

If you specify the EQUATE option without suboptions, EQUATE(BIT) is used. If you specify NOEQUATE (or select it by default), the EQU statements that follow a field are ignored.

You can specify the following suboptions for the EQUATE option:

**BIT** Indicates that the value for an EQU statement is used to define the bits for a field where the field conforms to the following rules:

- The field does not have a duplication factor of zero.
- The field has a length between 1 and 4 bytes and has a bit length that is a multiple of 8.
- The field does not have more than one nominal value.

and the EQU statements that follow the field conform to the following rules:

- The value for the EQU statements that follow the field mask consecutive bits (for example, X'80' followed by X'40').
- The value for an EQU statement masks one bit or consecutive bits for example, B'10000000' or B'11000000', but not B'10100000'.
- Where the length of the field is greater than 1 byte, the bits for the remaining bytes can be defined by providing the EQU statements for the second byte after the EQU statement for the first byte.
- The value for the EQU statement is not a relocatable value.

**Example:** When you specify EQUATE(BIT), the EQU statements are converted as in the following example:

```
FLAGFLD DS H
FLAG21 EQU X'80'
FLAG22 EQU X'40'
FLAG23 EQU X'20'
FLAG24 EQU X'10'
FLAG25 EQU X'08'
FLAG26 EQU X'04'
FLAG27 EQU X'02'
FLAG28 EQU X'01'
FLAG2A EQU X'80'
FLAG2B EQU X'40'
struct dsect_name {
    unsigned int flag21 : 1,
                  flag22 : 1,
                  flag23 : 1,
                  flag24 : 1,
                  flag25 : 1,
                  flag26 : 1,
                  flag27 : 1,
```

```

        flag28 : 1,
        flag2a : 1,
        flag2b : 1,
              : 6;
    }

```

- BITL** Indicates that the length attribute for an EQU statement is used to define the bits for a field where the field conforms to the following rules:
- The field does not have a duplication factor of zero.
  - The field has a length between 1 and 4 bytes and has a bit length that is a multiple of 8.
  - The field does not have more than one nominal value.

and the EQU statements that follow the field conform to the following rules:

- The value that is specified for the EQU statement has the same or overlapping offset as the field.
- The length attribute for the EQU statement is between 1 and 255.
- The length attribute for the EQU statement masks one bit or consecutive bits; for example, B'10000000' or B'11000000', but not B'10100000'.
- The value for the EQU statement is a relocatable value.

**Example:** When you specify EQUATE(BITL), the EQU statements are converted as in the following example:

```

BYTEFLD DS F
B1FLG1 EQU BYTEFLD+0,B'10000000'
B1FLG2 EQU BYTEFLD+0,B'01000000'
B1FLG3 EQU BYTEFLD+0,B'00100000'
B1FLG4 EQU BYTEFLD+0,B'00010000'
B1FLG5 EQU BYTEFLD+0,B'00001000'
B1FLG6 EQU BYTEFLD+0,B'00000100'
B1FLG7 EQU BYTEFLD+0,B'00000010'
B1FLG8 EQU BYTEFLD+0,B'00000001'
B2FLG1 EQU BYTEFLD+1,B'10000000'
B2FLG2 EQU BYTEFLD+1,B'01000000'
B2FLG3 EQU BYTEFLD+1,B'00100000'
B2FLG4 EQU BYTEFLD+1,B'00010000'
struct dsect_name {
    unsigned int b1flg1 : 1,
                 b1flg2 : 1,
                 b1flg3 : 1,
                 b1flg4 : 1,
                 b1flg5 : 1,
                 b1flg6 : 1,
                 b1flg7 : 1,
                 b1flg8 : 1,
                 b2flg1 : 1,
                 b2flg2 : 1,
                 b2flg3 : 1,
                 b2flg4 : 1,
                 : 20;
}

```

- DEF** Indicates that the EQU statements following a field are used to build #define directives to define the possible values for a field. The #define directives are placed after the end of the structure. The EQU statements should not specify a relocatable value.

**Example:** When you specify EQUATE(DEF), the EQU statements are converted as in the following example:

```

FLAGBYTE DS X
FLAG1 EQU X'80'
FLAG2 EQU X'20'
FLAG3 EQU X'10'
FLAG4 EQU X'08'

```



```

FLAG5    EQU  X'06'
FLAG6    EQU  X'01'
struct dsect_name {
    unsigned char flagbyte;
}
/* Values for flagbyte field */
#define flag1 0x80
#define flag2 0x20
#define flag3 0x10
#define flag4 0x08
#define flag5 0x06
#define flag6 0x01

```

## HDRSKIP | NOHDRSKIP

DEFAULT: NOHDRSKIP

The HDRSKIP option specifies that the fields within the specified number of bytes from the start of the section are to be skipped. Use this option where a section has a header that is not required in the structure produced.

The value that is specified on the HDRSKIP option indicates the number of bytes at the start of the section that are to be skipped. HDRSKIP(0) is equivalent to NOHDRSKIP.

**Example:** In the following example, if you specify HDRSKIP(8), the first two fields are skipped and only the remaining two fields are built into the structure.

```

SECTNAME DSECT
PREFIX1 DS CL4
PREFIX2 DS CL4
FIELD1 DS CL4
FIELD2 DS CL4
struct sectname {
    unsigned char field1[4];
    unsigned char field2[4];
}

```

If the value specified for the HDRSKIP option is greater than the length of the section, the structure is not be produced for that section.

## INDENT | NOINDENT

DEFAULT: INDENT(2)

The INDENT option specifies the number of character positions that the fields, unions, and substructures are indented. Turn off indentation by specifying INDENT(0) or NOINDENT. The maximum value that you can specify for the INDENT option is 32767.

## LOCALE | NOLOCALE

The LOCALE(*name*) specifies the name of a locale to be passed to the `setlocale()` function. Specifying LOCALE without the *name* parameter is equivalent to passing the NULL string to the `setlocale()` function.

The structure produced contains the left and right brace, and left and right square bracket, backslash, and number sign which have different code point values for the different code pages. When the LOCALE option is specified, and these characters are written to the output file, the code point from the LC\_SYNTAX category for the specified locale is used.

The default is NOLOCALE.

You can abbreviate the option to LOC(*name*) or NOLOC.

## LOWERCASE | NOLOWERCASE

DEFAULT: LOWERCASE>

The LOWERCASE> option specifies whether the field names within the C structure are to be converted to lowercase or left as entered. If you specify LOWERCASE>, all the field names are converted to lowercase. If you specify NOLOWERCASE, the field names are built into the structure in the case in which they were entered in the assembler section.

## LP64 | NOLP64

DEFAULT: NOLP64

The equivalent of NOLP64 for the compiler is the option ILP32, which means 32-bit integer, long, and pointer type. This is the default in the compiler as well. LP64 means 64-bit long and pointer type. LP64 and ILP32 specify the data model for the programming language.

The LP64 option instructs the DSECT utility to generate structures for use by the programs compiled with the LP64 option. When this option is enabled, address fields are mapped to C pointer types (64 bits), and 64-bit integer fields are mapped to long data types. C/C++ also supports a \_\_ptr32 qualifier for declaring pointers that are 32-bit in size, which means that if a field is explicitly specified with a 31-bit address, it is mapped to a \_\_ptr32 qualified pointer.

## OPTFILE | NOOPTFILE

The OPTFILE(*filename*) option specifies the *filename* that contains the records that specify the options to be used for processing the sections. The records must be as follows:

- The lines must begin with the SECT option, and only one section name must be specified. The options following determine how the structure is produced for the specified section. The section name must only be specified once.
- The lines may contain the BITF0XL, COMMENT, DEFSUB, EQUATE, HDRSKIP, INDENT, LOWERCASE, PPCOND, and UNNAMED options, separated by spaces or commas. These override the options that are specified on the command line for the section.

The OPTFILE option is ignored if the SECT option is also specified on the command line.

The default is NOOPTFILE.

You can abbreviate the option to OPTF(*filename*) or NOOPTF.

## PPCOND | NOPPCOND

DEFAULT: NOPPCOND

The PPCOND option specifies whether preprocessor directives will be built around the structure definition to prevent duplicate definitions.

If you specify PPCOND, the following are built around the structure definition.

```
#ifndef switch
#define switch
:
:
:
structure definition for section
:
:
:
#endif
```

where *switch* is the switch specified on the PPCOND option or the section name prefixed and suffixed by two underscores; for example, `__name__`.

If you specify a switch, the `#ifndef` and `#endif` directives are placed around all structures that are produced. If you do not specify a switch, the `#ifndef` and `#endif` directives are placed around each structure produced.

## SEQUENCE | NOSEQUENCE

DEFAULT: NOSEQUENCE

The SEQUENCE option specifies whether sequence numbers will be placed in columns 73 to 80 of the output record. If you specify the SEQUENCE option, the structure is built into columns 1 to 72 of the output record, and sequence numbers are placed in columns 73 to 80. If you specify NOSEQUENCE (or select it by default), sequence numbers are not generated, and the structure is built within all available columns in the output record.

If the record length for the output file is less than 80 characters, the SEQUENCE option is ignored.

## UNIQUE | NOUNIQUE

DEFAULT: NOUNIQUE

The UNIQUE option tells the DSECT utility to consider the given unique string as not occurring in any field names in the input SYSADATA. This is necessary because it is a guarantee from the user that if the DSECT utility were to use the unique string to map national characters, no conflict would occur with any other field name. Given this guarantee the DSECT utility maps national characters as follows:

```
# = unique string + 'n' + unique string
@ = unique string + 'a' + unique string
$ = unique string + 'd' + unique string
```

**Example:** If the default `"_"` unique string was used then the national characters would be mapped as:

```
# = _n_
@ = _a_
$ = _d_
```

If the default NOUNIQUE option is enabled, the DSECT utility converts all national characters to a single underscore, even if the resulting label names conflict (as is the existing behavior).

**Note:** If the DSECT utility detects a field name that has a length that exceeds the maximum allowed, a message is displayed and the name is truncated in the output. This can happen due to the substitution characters in the UNIQUE option. That is, the field name as specified by you is within the maximum limit, but due to the presence of national characters and the mapping done by UNIQUE, the resulting field name can exceed the limit. The DSECT utility

then ends the output field name with "..." to make it easy to find. You should check and fix the field name either by changing the UNIQUE option, or by shortening the original field name, or both.

## UNNAMED | NOUNNAMED

DEFAULT: NOUNNAMED

The UNNAME option specifies that names are not generated for the unions and substructures within the main structure.

## OUTPUT

DEFAULT: OUTPUT(DD:EDCDSECT)

The structures that are produced are, by default, written to the EDCDSECT DD statement. You can use the OUTPUT option to specify an alternative DD statement or data set name to write the structure. You can specify any valid file name up to 60 characters in length. The file name specified will be passed to fopen() as entered.

## RECFM

DEFAULT: C/C++ Library default

The RECFM option specifies the record format for the file to be produced. You can specify up to 10 characters. If it is not specified, the C or C++ library defaults are used.

## LRECL

DEFAULT: C/C++ Library default

The LRECL option specifies the logical record length for the file to be produced. The logical record length that is specified must not be greater than 32767. If it is not specified, the C or C++ library defaults will be used.

## BLKSIZE

DEFAULT: C/C++ Library default

The BLKSIZE option specifies the block size for the file to be produced. The block size that is specified must not be greater than 32767. If it is not specified, the C or C++ library defaults will be used.

---

## Generation of structures

The structure is produced as follows according to the options in effect.

- The section name is used as the structure name. A **#pragma pack(packed)** is generated at the top of the file, and a **#pragma pack(reset)** is generated at the end to ensure that the structure matches the assembler section. For example:

```
#pragma pack(packed)
struct dsect_name {
    :
};
#pragma pack(reset)
```

- Any nonalphanumeric characters in the section or field names are converted to underscores. Duplicate names may be generated when the field names are identical except for the national character. No warning is issued.

- Where fields overlap, a substructure or union is built within the main structure. A substructure is produced where possible. When substructures and unions are built, the DSECT utility generates the structure and union names.
- The substructures and unions within the main structure are indented according to the INDENT option unless the record length is too small to permit any further indentation.
- Fillers are added within the structure when required. The DSECT utility generates a filler name.
- Where there is no direct equivalent for an assembler definition within the C or C++ language, the field is defined as a character field.
- If a field has a duplication factor of zero, but cannot be used as a structure name, the field is defined as though the duplication factor of zero was eliminated.
- Where a line within the assembler input consists of an operand with a duplication factor of zero (for alignment), followed by the field definition, the first operand is skipped. For example:

```
FIELDA DS OF,CLB
```

is treated as though the following was specified.

```
FIELDA DS CLB
```

- When the COMMENT option is in effect, the comment on the line that follows the definition of the field is placed in the structure. The comment is placed on the same line as the field definition where possible, or on the following line.  
/\* is removed from the beginning of comments, and \*/ is removed from the end of comments. Any remaining instances of \*/ in the comment are converted to \*\*.

Each field within the section is converted to a field within the structure, as the following examples show:

- Bit length fields

If the field has a bit length that is not a multiple of 8, it is converted as follows. Otherwise, it is converted according to the field type.

**DS CL.n** unsigned int name : n; where n is from 1 to 31.

**DS CL.n** unsigned char name[x]; where n is greater than 32. x will be the number of bytes that are required (that is, the bit length / 8 + 1).

**DS 5CL.n** unsigned char name[x]; where x will be the number of bytes required (that is, the duplication factor \* bit length / 8 + 1).

- Characters

**DS C** unsigned char name;

**DS CL2** unsigned char name[2];

**DS 4CL2** unsigned char name[4][2];

- Graphic Characters

**DS G** wchar\_t name;

**DS GL1** unsigned char name;

**DS GL2** wchar\_t name;

**DS GL3** unsigned char name[3];

**DS 4GL1** unsigned char name[4];

**DS 4GL2** wchar\_t name[4];

**DS 4GL3** unsigned char name[4][3];

- Hexadecimal Characters

**DS X** unsigned char name;

**DS XL2** unsigned char name[2];

**DS 4XL2** unsigned char name[4][2];

- Binary fields
  - DS B** unsigned char name;
  - DS BL2** unsigned char name[2];
  - DS 4BL2** unsigned char name[4][2];
- Half and Fullword Fixed-point
  - DS F** int name;
  - DS H** short int name;
  - DS FL1 or HL1** char name;
  - DS FL2 or HL2** short int name;
  - DS FL3 or HL3** int name : 24;
  - DS FLn or HLn** unsigned char name[n]; where n is greater than 4.
  - DS 4F** int name[4];
  - DS 4H** short int name[4];
  - DS 4FL1 or 4HL1** char name[4];
  - DS 4FL2 or 4HL2** short int name[4];
  - DS 4FL3 or 4HL3** unsigned char name[4][3];
  - DS 4FLn or 4HLn** unsigned char name[4][n]; where n is greater than 4.
- Floating Point
  - DS E** float name;
  - DS D** double name;
  - DS L** long double name;
  - DS 4E** float name[4];
  - DS 4D** double name[4];
  - DS 4L** long double name[4];
  - DS EL4 or DL4 or LL4** float name;
  - DS EL8 or DL8 or LL8** double name;
  - DS LL16** long double name;
  - DS E, D or L** unsigned char name[n]; where n is other than 4, 8, or 16.
- Packed Decimal
  - DS P** unsigned char name;
  - DS PL2** unsigned char name[2];
  - DS 4PL2** unsigned char name[4][2];
- Zoned Decimal
  - DS Z** unsigned char name;
  - DS ZL2** unsigned char name[2];
  - DS 4ZL2** unsigned char name[4][2];
- Address
  - DS A** void \*name;
  - DS AL1** unsigned char name;
  - DS AL2** unsigned short name;
  - DS AL3** unsigned int name : 24;
  - DS 4A** void \*name[4];
  - DS 4AL1** unsigned char name[4];
  - DS 4AL2** unsigned short name[4];
  - DS 4AL3** unsigned char name[4][3];
- Y-type Address
  - DS Y** unsigned short name;
  - DS YL1** unsigned char name;
  - DS 4Y** unsigned short name[4];
  - DS 4YL1** unsigned char name[4];

- S-type Address (Base and displacement)
  - DS S** unsigned short name;
  - DS SL1** unsigned char name;
  - DS 4S** unsigned short name[4];
  - DS 4SL1** unsigned char name[4];
- External Symbol Address
  - DS V** void \*name;
  - DS VL3** unsigned int name : 24;
  - DS 4V** void \*name[4];
  - DS 4VL3** unsigned char name[4][3];
- External Dummy Section Offset
  - DS Q** unsigned int name;
  - DS QL1** unsigned char name;
  - DS QL2** unsigned short name;
  - DS QL3** unsigned int name : 24;
  - DS 4Q** unsigned int name[4];
  - DS 4QL1** unsigned char name[4];
  - DS 4QL2** unsigned short name[4];
  - DS 4QL3** unsigned char name[4][3];
- Channel Command Words
 

When a CCW, CCW0, or CCW1 assembler instruction is present within the section, a typedef ccw0\_t or ccw1\_t is defined to map the format of the CCW. The CCW, CCW0, or CCW1 is built into the structure as follows:

|                                 |        |       |
|---------------------------------|--------|-------|
| <b>CCW cc,addr,flags,count</b>  | ccw0_t | name; |
| <b>CCW0 cc,addr,flags,count</b> | ccw0_t | name; |
| <b>CCW1 cc,addr,flags,count</b> | ccw1_t | name; |

---

## Under z/OS batch

**Example:** You can use the IBM-supplied cataloged procedure EDCDSECT to execute the DSECT utility as in the following example.

```

KNOWN:  - The assembler source name is FRED.SOURCE(TESTASM).
        - The structure is to be written to FRED.INCLUDE(TESTASM).
        - The required DSECT Utility options are EQU(BIT).

USE THE FOLLOWING JCL:
//DSECT EXEC PROC=EDCDSECT,
//      INFILE='FRED.SOURCE(TESTASM)',
//      OUTFILE='FRED.INCLUDE(TESTASM)',
//      DPARM='EQU(BIT)'
```

*Figure 46. Running the DSECT Utility under z/OS batch*

EDCDSECT invokes the High Level Assembler to assemble the source that is provided with the ADATA option. It then executes the DSECT utility to produce the structure. It writes the structure to the data set that is specified by the OUTFILE parameter, unless the OUTPUT option is also specified. A report that indicates the options in effect and any error messages is written to SYSOUT.

If the assembler source requires macros or copy members from a macro library, include them on the SYSLIB DD for the ASSEMBLY step.

The parameters to the EDCDSECT procedure are:

Table 43. EDCDSECT procedure parameters

| Parameter | Description  |
|-----------|--|
| INFILE    | Input assembler source data set name. This option must be provided.  |
| OUTFILE   | The data set name for the file into which the structure is written.<br>If you do not specify an OUTFILE name, a temporary data set is generated. |
| APARM     | High Level Assembler options.  |
| DPARM     | DSECT Utility options.   |

## Under TSO

If you have REXX installed, you can run the DSECT utility under TSO by using the CDSECT EXEC. The format of the parameters for the CDSECT EXEC is:

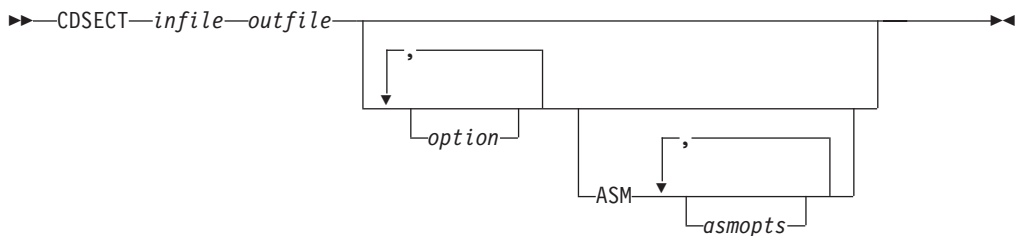

where *infile* specifies the file name of the assembler source program containing the required section. *outfile* specifies the file that the structure produced is written to, and *option* is any valid DSECT utility option. If you specify ASM, any following options must be High-Level Assembler options. The ADATA is specified by default.

- KNOWN:
- The assembler source name is FRED.SOURCE(TESTASM).
  - The structure is to be written to FRED.INCLUDE(TESTASM).
  - The required DSECT Utility options are EQU(BIT).

USE THE FOLLOWING COMMAND:  
 CDSECT 'FRED.SOURCE(TESTASM)' 'FRED.INCLUDE(TESTASM)' EQU(BIT)

Figure 47. Running the DSECT Utility under TSO

When the CDSECT command is executed, the High Level Assembler is executed with the required options. The DSECT utility is then executed with the specified options. A report of the options and any error messages will be displayed on the terminal.

If the assembler source requires macros or copy members from a macro library, issue the ALLOCATE command to allocate the required macro libraries to the SYSLIB DD statement before issuing the CDSECT command.



---

## Chapter 16. Coded character set and locale utilities

This chapter describes the coded character set conversion utilities and the localedef utility. The coded character set conversion utilities help you to convert a file from one coded character set to another. The localedef utility allows you to define the language and cultural conventions that your environment uses.

---

### Coded character set conversion utilities

These are the coded character set conversion utilities that you may find useful:

**iconv** Converts a file from one coded character set encoding to another. You can use iconv to convert C source code before compilation or to convert input files. For more information, refer to *z/OS UNIX System Services Command Reference*.

**uconvdef**

Reads the input source file and creates a binary conversion table. The input source file defines a mapping between UCS-2 and multibyte code sets. For more information, refer to *z/OS UNIX System Services Command Reference*.

**genxlt** Generates a translate table that the iconv utility and the iconv family of functions can use to convert coded character sets. It can be used to build code set converters for code pages that are not supplied with z/OS XL C/C++, or to build code set conversions for existing code pages.

The genxlt utility runs under z/OS batch and TSO. The iconv utility runs under z/OS batch, TSO, and the z/OS shell. The `iconv_open()`, `iconv()`, and `iconv_close()` functions can be called from applications running under these environments and CICS/ESA®.

### iconv utility

The iconv utility converts the characters from the input file from one coded character set (code set) definition to another code set definition, and writes the characters to the output file.

The iconv utility creates one character in the output file for each character in the input file, and does not perform padding or truncation.

When conversions are performed between single-byte code pages, the output files are the same length as the input files. When conversions are performed between double-byte code pages, the output files may be longer or shorter than the input files because the shift-out and shift-in characters may be added or removed. If you are using the iconv utility under the z/OS shell, see *z/OS UNIX System Services Command Reference* for details on syntax and uses.

There are three standard library functions that can be used by any application to change the character set of data. These functions are `iconv_open()`, `iconv()`, and `iconv_close()`. For more information on the iconv utility, see *z/OS XL C/C++ Run-Time Library Reference*.

#### Under z/OS batch

JCL procedure EDCICONV invokes the iconv utility to copy the input data set to the output data set and convert the characters from the input code page to the output code page.

The EDCICONV procedure has the following parameters:

|                |  |
|----------------|--|
| <b>INFILE</b>  | The data set name for the input data set                             |
| <b>OUTFILE</b> | The data set name for the output data set                            |
| <b>FROMC</b>   | The name of the code set in which the input data is encoded          |
| <b>TOC</b>     | The name of the code set to which the output data is to be converted |

**Example:**

```
//ICONV EXEC PROC=EDCICONV,  
//      INFILE='FRED.INFILE',  
//      OUTFILE='FRED.OUTFILE',  
//      FROMC='IBM-037',  
//      TOC='IBM-1047'
```

The output data set must be preallocated. If the data set does not exist, iconv will fail. An output data set with a fixed record format may only be used if all the records created by the iconv utility will have the same record length as the output data set. No padding or truncation is performed. If the output data set has variable length records, the record length must be large enough for the longest record created. Because of these restrictions, when converting to or from a DBCS, the output data set must have variable length records. Otherwise, the iconv utility will fail.

For more information on the iconv utility, refer to *z/OS XL C/C++ Programming Guide*.

**Under TSO**

TSO CLIST ICONV invokes the iconv utility to copy the input data set to the output data set and convert the characters from the input code page to the output code page.

The parameters of the ICONV CLIST are as follows:

►►—ICONV—*infile*—*outfile*—FROMCODE(*—fromcode—*)—TOCODE(*—tocode—*)—————►◄

Where:

|                 |   |
|-----------------|---|
| <i>infile</i>   | The input data set name.  |
| <i>outfile</i>  | The output data set name.   |
| <i>fromcode</i> | The name of the code set in which the input data is encoded.          |
| <i>tocode</i>   | The name of the code set to which the output data is to be converted. |

**Example:**

```
ICONV INPUT.FILE OUTPUT.FILE FROMCODE(IBM-037) TOCODE(IBM-1047)
```

The output data set must be pre-allocated. If the data set does not exist, iconv will fail. An output data set with a fixed record format may only be used if all the records created by the iconv utility will have the same record length as the output data set. No padding or truncation is performed. If the output data set has variable length records, the record length must be large enough for the longest record created. Because of these restrictions, when converting to or from a DBCS, the output data set must have variable length records. Otherwise the iconv utility will fail.

For more information on `iconv`, refer to *z/OS XL C/C++ Programming Guide*.

## Under the z/OS Shell

Under z/OS UNIX System Services, use the **iconv** command to invoke the `iconv` utility. The following is the invocation syntax for the **iconv** command:

```
iconv [-sc] -f oldset -t newset [file ...]
```

or

```
iconv -l [-v]
```

The `iconv` utility converts characters in *file* (or from `stdin` if you do not specify a *file*) from one code page set to another. It writes the converted text to `stdout`. See *z/OS XL C/C++ Programming Guide* for more information about the code sets that are supported for this command.

If the input contains a character that is not valid in the source code set, `iconv` replaces it with the byte `0xff` and continues, unless the `-c` option is specified.

If the input contains a character that is not valid in the destination code set, the behavior depends on the `iconv()` function of the system. See *z/OS XL C/C++ Run-Time Library Reference* for more information about the character that is used for converting incorrect characters.

You can use `iconv` to convert single-byte data or double-byte data.

### Options:

- `-c` Characters that contain conversion errors are not written to the output. By default, characters not in the source character set are converted to the value `0xff` and written to the output.
- `-f oldset` *oldset* can be either the code set name or a pathname to a file that contains an external code set. Specifies the current code set of the input.
- `-l` Lists code sets in the internal table. This option is not supported.
- `-s` Suppresses all error messages about faulty encodings.
- `-t newset` Specifies the destination code set for the output. *newset* can be either the code set name or a pathname to a file that contains an external code set.
- `-v` Specifies verbose output.

## genxlt utility

The `genxlt` utility creates translation tables, which are used by the `iconv_open()`, `iconv()`, and `iconv_close()` services of the run-time library. These services can be called from both non-XPLINK and XPLINK applications. The non-XPLINK and XPLINK versions have different names. The non-XPLINK and XPLINK versions of the GENXLT table should always be generated. If any XPLINK applications will require one of these translation tables, then the XPLINK version should also be generated.

Under TSO, you specify the options on the command line. Under z/OS batch, the options are specified on the EXEC PARM, and may be separated by spaces or commas. If you specify the same option more than once, genxlt uses the last specification.

**DBCS** | **NODBCS** Specifies whether genxlt will convert the DBCS characters within shift-out and shift-in characters. You should only specify the DBCS option when you are converting an EBCDIC code page to a different EBCDIC code page.

If the DBCS option is specified, when a shift-out character is encountered in the input, the characters up to the shift-in character are copied to the output, and not converted. There must be an even number of characters between the shift-out and shift-in characters, and the characters must be valid DBCS characters.

If you specify the NODBCS option, genxlt treats all the characters as a single SBCS character, and does not perform a check of DBCS characters.

For more information on the genxlt utility, refer to *z/OS XL C/C++ Programming Guide*.

### Under z/OS batch

JCL procedure EDCGNXLT invokes the genxlt utility to read the character conversion information and produce the conversion table. It invokes the system Linkage Editor to build the load module.

The EDCGNXLT procedure has the following parameters:

|         |  |
|---------|--|
| INFILE  | The data set name for the file that contains the character conversion information.   |
| OUTFILE | The data set name for the output file that is to contain the link-edited conversion table. The non-XPLINK version of this table should have EDCU as the first four characters. The XPLINK version of this table should have CEHU as the first four characters. |
| GOPT    | Options for the genxlt utility.  |

#### Example:

```
//GENXLT EXEC PROC=GENXLT,  
//      INFILE='FRED.GENXLT.SOURCE(EDCUEAEY)',  
//      OUTFILE='FRED.GENXLT.LOADLIB(EDCUEAEY)',  
//      GOPT='DBCS'
```

### Under TSO

TSO CLIST GENXLT invokes the genxlt utility to read the character conversion information and produce the conversion table. It then invokes the system Linkage Editor to build the load module.

The general parameters for GENXLT CLIST are as follows:

►► GENXLT—infile—outfile —————►

|        |
|--------|
| DBCS   |
| NODBCS |

Where:

*infile* The file name for the file that contains the character conversion information.

*outfile* The file name for the output file that is to contain the link-edited conversion table. The non-XPLINK version of the table should have EDCU as the first four characters. The XPLINK version of this table should have CEHU as the first four characters.

For example:

```
GENXLT GENXLT.SOURCE(EDCUEAEY) GENXLT.LOADLIB(EDCUEAEY) DBCS
```

## localedef utility

A *locale* is a collection of data that defines language and cultural conventions. Locales consist of various categories, that are identified by name, that characterize specific aspects of your cultural environment.

The localedef utility generates locales according to the rules that are defined in the locale definition file. You can create your own customized locale definition file.

The localedef utility creates locale objects, which are used by the `setlocale()` service of the run-time library. This service can be called from both non-XPLINK and XPLINK applications. The non-XPLINK, XPLINK, and 64-bit locale object versions have different names. Also, localedef can generate the locale objects into a PDS or PDSE under BATCH or TSO, or into the z/OS UNIX System Services file system under the z/OS shell. The non-XPLINK, XPLINK, and 64-bit versions of the locale object should always be generated.

The utility reads the locale definition file and produces a locale object that the locale-specific library functions can use. You invoke localedef using either a JCL procedure or a TSO CLIST, or by specifying the **localedef** command under z/OS UNIX System Services. To activate a locale during your application's execution, you call the run-time function `setlocale()`.

**Note:** TSO and z/OS batch are not supported for building 64-bit locales. You must use the **localedef** command under z/OS UNIX System Services to build 64-bit locales.

The options for the localedef utility in TSO or z/OS batch are as follows. Spaces or commas can separate the options. If you specify the same option more than once, localedef uses the last option that you specified.

**CHARMAP**(*name*) Specifies the member name of the file that contains the definition of the encoded character set. If you do not specify this option, the localedef utility assumes the encoded character set IBM-1047.

The name that is specified for the CHARMAP is the member name within a partitioned data set, with the – (dash) sign converted to an @ (at) sign.

**FLAG**(WIE)

The FLAG option controls whether localedef issues warning messages. If you specify FLAG(W), localedef issues warning and error messages. If you specify FLAG(E), localedef issues only the error messages.

**BLDERR**INOBLDERR

If you specify the BLDERR option, localedef generates the locale even if it detects errors. If you

specify the NOBLDERR option, localedef does not generate the locale if it detects an error.

The following sections describe how you can invoke the localedef utility. For more information on locale source definition files, codeset mapping files (CHARMAPs), method files, and locale object names, refer to *z/OS XL C/C++ Programming Guide*. For information on using the localedef utility under z/OS UNIX System Services, refer to *z/OS UNIX System Services Command Reference*.

## Under z/OS batch

Note: To build XPLINK optimized locales, use EDCXLDEF.

Under z/OS batch, JCL procedure EDCLDEF invokes the localedef utility. It does the following:

1. Invokes the EDCLDEF module to read the locale definition data set and produces the C code to build the locale
2. Invokes the z/OS XL C compiler to compile the C source generated
3. Invokes the Linkage Editor to build the locale into a loadable module

The EDCLDEF JCL procedure has the following parameters:

|                |  |
|----------------|--|
| <b>INFILE</b>  | The data set name for the file that contains the locale definition information.  |
| <b>OUTFILE</b> | For non-XPLINK, it is the data set name for the output partitioned data set and member that is to contain the link-edited locale object. For XPLINK, it is the data set name for the output PDSE and member that is to contain the bound locale object. The non-XPLINK version of the locale object should have EDC\$ or EDC@ as the first four characters of the member name. The name that is chosen determines the locale that is built (for further information, see <i>z/OS XL C/C++ Programming Guide</i> ). The XPLINK version should have CEH\$ or CEH@ as the first four characters of the member name. |
| <b>LOPT</b>    | The options for the localedef utility  |

### Example:

```
//LOCALDEF EXEC PROC=EDCLDEF,  
//          INFILE='FRED.LOCALE.SOURCE(EDC$EUEY)',  
//          OUTFILE='FRED.LOCALE.LODLIB(EDC$EUEM)',  
//          LOPT='CHARMAP(IBM-297)'
```

Under z/OS batch, you specify the options on the EXEC PARM and separate them by spaces or commas.

## Under TSO

Under TSO, LOCALDEF invokes the localedef utility. The name is shortened to 8 characters from LOCALEDEF because of the file naming restrictions. It does the following:

1. Invokes the EDCLDEF module to read the locale definition data set and produce the C code to build the locale
2. Invokes the z/OS XL C compiler to compile the C source
3. Invokes the Linkage Editor to build the locale into a loadable module

The invocation syntax for the LOCALDEF REXX EXEC is as follows:

▶▶ LOCALDEF *infile* *outfile* [LOPT(*options*)] [XPLINK] ▶▶

where:

- infile*            The data set name for the data set that contains the locale definition information
- outfile*           For non-XPLINK, it is the data set name for the output partitioned data set and member that is to contain the link-edited locale object. For XPLINK, it is the data set name for the output PDSE and member that is to contain the bound locale object. The non-XPLINK version of the locale object should have EDC\$ or EDC@ as the first four characters of the member name. The XPLINK version should have CEH\$ or CEH@ as the first four characters of the member name.
- options*           The options for the localedef utility.
- XPLINK**           Indicates that the locale to be built is an XPLINK locale.

**Example:** In the following example, the input source is LOCALE.SOURCE(EDC\$EUEY), the output library is LOCALE.LOADLIB(EDC\$EUEM) for en\_us.IBM-297, and the options are CHARMAP(IBM-297):

```
LOCALEDEF LOCALE.SOURCE(EDC$EUEY) LOCALE.LOADLIB(EDC$EUEM) LOPT(CHARMAP(IBM-297))
```

Under TSO, you specify the options on the command line.

## Under the z/OS Shell

Under z/OS UNIX System Services, use the **localedef** command to invoke the localedef utility. The following is the invocation syntax for the **localedef** command:

```
localedef [-c] [-w] [-X] [-A][-f charmap] [-i sourcefile] [-m] [-L binderoptions] name
```

### Options:

- A**            Causes localedef to generate an ASCII locale object. ASCII locales invoke ASCII methods, so they must be generated using ASCII *charmaps*. An ASCII *charmap* maps symbolic character names into ASCII code points, but even ASCII *charmap* specifications are written in EBCDIC code page IBM-1047. Users must ensure that the *charmap* specified, when they invoke the localedef utility, is an ASCII *charmap*. Note: When -A is specified, -X is assumed because ASCII locales are only supported as XPLINK locales.
- c**            Creates permanent output even if there were warning messages. Normally, localedef does not create permanent output when it has issued warning messages.
- f *charmap***    Specifies a *charmap* file that contains a mapping of character symbols and collating element symbols to actual character encodings.
- i *sourcefile***   Specifies the file that contains the source definitions. If there is no -i, localedef reads the source definitions from the standard input.
- m *MethodFile***   Specifies the names of a method file that identifies the methods to be overridden when constructing a locale object. The localedef utility reads a method file and uses indicated entry points when



constructing a locale object. Method files are used to replace IBM-supplied method functions with user-written method functions. For each replaced method, the *method file* supplies the user-written method function name and optionally indicates where the method function code is to be found (.o file, archive library or DLL). Method files typically replace the *charmap* related methods. When this is done, the end result is the creation of a locale, which supports a blended code page. The user-written method functions are used both by the locale-sensitive APIs they represent, and also by localedef itself while generating the method-file based ASCII locale object. This second use by localedef itself causes a temporary DLL to be created, while processing the *charmap* file supplied on the **-f** parameter. The name of the file containing method objects or side deck information is passed by localedef as a parameter on the c89 command line, so the standard archive/object/side deck suffix naming conventions apply (in other words, .a, .o, .x).

**Note:** Method files may only be used when constructing ASCII locale objects (that is, when the **-A** option is also specified). If the **-A** option is not specified along with the **-m** option, then a severe error message will be issued and processing will be terminated.

- w** Instructs localedef to issue a warning message when a duplicate character definition is found. This is mainly intended for debugging character map specifications. It can help to ensure that a code point value is not accidentally assigned to the wrong symbolic character name.
- X** Causes localedef to generate an XPLINK AMODE 31 locale object (DLL).
- L binderoptions** Instructs localedef to pass additional binder options (mostly for diagnostic purposes).
- 6** Instructs localedef to generate an XPLINK AMODE 64 locale object (DLL). The **-X** option is implied when this option is specified.
- name** Is the name applied to the target locale object generated by localedef. Locale naming conventions are described in detail in *z/OS XL C/C++ Programming Guide*. If the naming conventions are not followed, applications are required to supply the full path name on each `setlocale()` invocation of locales that reside in the z/OS UNIX file system.

z/OS ships two versions of the localedef utility:

- One can be invoked under z/OS batch and TSO, and is shipped with the z/OS XL C/C++ compiler.
- The other can be invoked under z/OS UNIX System Services, and is shipped with z/OS UNIX.

The TSO REXX Exec localedef, included in the z/OS XL C/C++ compiler, is not supported in the z/OS shell environment. In that environment, use the z/OS UNIX System Services **localedef** command instead. For more information on the **localedef** command, refer to *z/OS UNIX System Services Command Reference*.



---

## Part 5. z/OS UNIX System Services utilities

This part contains information about the z/OS UNIX System Services utilities.

- Chapter 17, “Archive and make utilities,” on page 479
- Chapter 18, “BPXBATCH utility,” on page 481
- Chapter 19, “as — Use the HLASM assembler to produce object files,” on page 485
- Chapter 20, “c89 — Compiler invocation using host environment variables,” on page 489
- Chapter 21, “xlc — Compiler invocation using a customizable configuration file,” on page 527



---

## Chapter 17. Archive and make utilities

This chapter describes the z/OS UNIX System Services archive (`ar`) and make utilities. There are several other useful z/OS UNIX System Services utilities such as `gencat` and `mkcatdefs`. For information on their syntax and use, refer to *z/OS UNIX System Services Command Reference*.

The z/OS Shell and Utilities provide two utilities that you can use to simplify the task of creating and managing z/OS UNIX System Services XL C/C++ application programs: `ar` and `make`. Use these utilities with the `c89` and `c++` utilities to build application programs into easily updated and maintained executable files.

---

### Archive libraries

The `ar` utility allows you to create and maintain a library of z/OS XL C/C++ application object files. You can specify the `c89` and `c++` command strings so that archive libraries are processed during the IPA Link step or binding.

The archive library file, when created for application program object files, has a special symbol table for members that are object files. The symbol table is read to determine which object files should be bound into the application program executable file. The binder processes archive libraries during the binding process. It includes any object file in the specified archive library that it can use to resolve external symbols. Use of this autocall library mechanism is analogous to the use of Object Libraries with object files in data sets. For more information, see Chapter 13, “Object library utility,” on page 437.

By default, the `c89` and `c++` utilities require that archive libraries end in the suffix `.a`, as in `file.a`. For example; source file `dirsum.c` is in your `src` subdirectory in your working directory, and the archive library `symb.a` is in your working directory. To compile `dirsum.c` and resolve external symbols from `symb.a`, and create the executable in `exfils/dirsum` enter:

```
c89 -o exfils/dirsum src/dirsum.c symb.a
```

---

### Creating archive libraries

To create the archive library, use the `ar -r` option.

**Example:** To create an archive library that is named `bin/libbrobompgm.a` from your working directory, and add the member `jkeyadd.o` to it, specify:

```
ar -rc ./bin/libbrobompgm.a jkeyadd.o
```

`ar` creates the archive library file `libbrobompgm.a` in the `bin` subdirectory of your z/OS UNIX System services working directory. The `-c` option tells `ar` to suppress the message that it normally sends when it creates an archive library file.

**Example:** For control purposes, and when working interactively, you can use the `-v` option to generate a message as each member is added to the archive:

```
ar -rv ./bin/libbrobompgm.a jkeyadd.o
```

**Example:** To display the object files that are archived in the `bin/libbrobompgm.a` library from your working directory, specify:

```
ar -t ./bin/libbrobompgm.a
```

For a detailed discussion of the ar utility, see *z/OS UNIX System Services Command Reference*.

---

## Creating makefiles

The make utility maintains all the parts of and dependencies for your application program. It uses a makefile, to keep your application parts (listed in it) up to date with one another. If one part changes, make updates all the other files that depend on the changed part.

A *makefile* is a z/OS UNIX System Services text file. You can use any text editor to create and edit the file. It describes the application program files, their locations, dependencies on other files, and rules for building the files into an executable file. When creating a makefile, remember that tabbing of information in the file is important and not all editors support tab characters the same way.

The make utility uses c89 or c++ to call the z/OS XL C/C++ compiler, and the binder, to recompile and rebind an updated application program.

See *z/OS UNIX System Services Programming Tools* and *z/OS UNIX System Services Command Reference* for a detailed discussion of the shell make utility.

## Makedepend utility

The makedepend utility can also be used to create a makefile. The makedepend utility is used to analyze each source file to determine what dependency it has on other files. This information is then placed into a usable makefile. See *z/OS UNIX System Services Command Reference* for a detailed discussion of the makedepend utility.

---

## Chapter 18. BPXBATCH utility

This chapter provides a quick reference for the IBM-supplied BPXBATCH program. BPXBATCH makes it easy for you to run shell scripts and z/OS XL C/C++ executable files that reside in z/OS UNIX System Services files through the z/OS batch environment. If you do most of your work from TSO/E, use BPXBATCH to avoid going into the shell to run your scripts and applications.

In addition to using BPXBATCH, if you want to perform a local spawn without being concerned about environment set-up (that is, without having to set specific environment variables, which could be overwritten if they are also set in your profile) you can use BPXBATSL. BPXBATSL, which provide you with an alternate entry point into BPXBATCH, and force a program to run using a local spawn instead of fork or exec as BPXBATCH does. This ultimately allows a program to run faster.

BPXBATSL is also useful when you want to perform a local spawn of your program, but also need subsequent child processes to be forked or executed. Formerly, with BPXBATCH, this could not be done since BPXBATCH and the requested program shared the same environment variables. BPXBATSL is provided as an alternative to BPXBATCH. It will force the running of the target program into the same address space as the job itself is initiated in, so that all resources for the job can be used by the target program; for example, DD allocations. In all other respects, it is identical to BPXBATCH.

For information on c89 commands, see Chapter 20, “c89 — Compiler invocation using host environment variables,” on page 489.

---

### BPXBATCH usage

The BPXBATCH program allows you to submit z/OS batch jobs that run shell commands, scripts, or z/OS XL C/C++ executable files in z/OS UNIX System Services files from a shell session. You can invoke BPXBATCH from a JCL job, from TSO/E (as a command, through a CALL command, from a REXX EXEC).

**JCL:** Use one of the following:

- EXEC PGM=BPXBATCH,PARM='SH program-name'
- EXEC PGM=BPXBATCH,PARM='PGM program-name'

**TSO/E:** Use one of the following:

- BPXBATCH SH program-name
- BPXBATCH PGM program-name

BPXBATCH allows you to allocate the z/OS standard files `stdin`, `stdout`, and `stderr` as z/OS UNIX files for passing input, for shell command processing, and writing output and error messages. If you do allocate standard files, they must be z/OS UNIX files. If you do not allocate them, `stdin`, `stdout`, and `stderr` default to `/dev/null`. You allocate the standard files by using the options of the data definition keyword `PATH`.

**Note:** The BPXBATCH utility also uses the `STDENV` file to allow you to pass environment variables to the program that is being invoked. This can be useful when not using the shell, such as when using the `PGM` parameter.

**Example:** For JCL jobs, specify PATH keyword options on DD statements; for example:

```
//jobname JOB ...

//stepname EXEC PGM=BPXBATCH,PARM='PGM program-name parm1 parm2'

//STDIN DD PATH='/stdin-file-pathname',PATHOPTS=(ORDONLY)
//STDOUT DD PATH='/stdout-file-pathname',PATHOPTS=(OWRONLY,OCREAT,OTRUNC),
// PATHMODE=SIRWXU
//STDERR DD PATH='/stderr-file-pathname',PATHOPTS=(OWRONLY,OCREAT,OTRUNC),
// PATHMODE=SIRWXU
:
```

You can also allocate the standard files dynamically through use of SVC 99.

For TSO/E, you specify PATH keyword options on the ALLOCATE command. For example:

```
ALLOCATE FILE(STDIN) PATH('/stdin-file-pathname') PATHOPTS(ORDONLY)
ALLOCATE FILE(STDOUT) PATH('/stdout-file-pathname')
PATHOPTS(OWRONLY,OCREAT,OTRUNC) PATHMODE(SIRWXU)
ALLOCATE FILE(STDERR) PATH('/stderr-file-pathname')
PATHOPTS(OWRONLY,OCREAT,OTRUNC) PATHMODE(SIRWXU)

BPXBATCH SH program-name
```

You must always allocate stdin as read. You must always allocate stdout and stderr as write.

## Parameter

BPXBATCH accepts one parameter string as input. At least one blank character must separate the parts of the parameter string. When BPXBATCH is run from a batch job, the total length of the parameter string must not exceed 100 characters. When BPXBATCH is run from TSO, the parameter string can be up to 500 characters. If neither SH nor PGM is specified as part of the parameter string, BPXBATCH assumes that it must start the shell to run the shell script allocated by stdin.

### SH | PGM

Specifies whether BPXBATCH is to run a shell script or command or a z/OS XL C/C++ executable file that is located in a z/OS UNIX System Services file.

**SH** Instructs BPXBATCH to start the shell, and to run shell commands or scripts that are provided from stdin or the specified *program-name*.

**Note:** If you specify SH with no program-name information, BPXBATCH attempts to run anything read in from stdin.

**PGM** Instructs BPXBATCH to run the specified *program-name* as a called program.

If you specify PGM, you must also specify *program-name*. BPXBATCH creates a process for the program to run in and then calls the program. The HOME and LOGNAME environment variables are set automatically when the program is run, only if they do not exist in the file that is referenced by STDENV. You can use STDENV to set these environment variables, and others.

*program-name*

Specifies the shell command or the z/OS UNIX path name for the shell script or z/OS XL C/C++ executable file to be run. In addition, *program-name* can contain option information.

BPXBATCH interprets the program name as case-sensitive.

**Note:** When PGM and *program-name* are specified and the specified program name does not begin with a slash character (/), BPXBATCH prefixes your *initial* working directory information to the program path name.

## Usage notes

You should be aware of the following:

1. BPXBATCH is an alias for the program BPXMBATC, which resides in the SYS1.LINKLIB data set.
2. BPXBATCH must be invoked from a user address space running with a program status word (PSW) key of 8.
3. BPXBATCH does not perform any character translation on the supplied parameter information. You should supply parameter information, including z/OS UNIX path names, using only the POSIX portable character set.
4. A program that is run by BPXBATCH cannot use allocations for any files other than stdin, stdout, or stderr.
5. BPXBATCH does not close file descriptors except for 0, 1, and 2. Other file descriptors that are open and not defined as “marked to be closed” remain open when you call BPXBATCH. BPXBATCH runs the specified script or executable file.
6. BPXBATCH uses write-to-operator (WTO) routing code 11 to write error messages to either the JCL job log or your TSO/E terminal. Your TSO/E user profile must specify WTPMSG so that BPXBATCH can display messages to the terminal.

## Files

The following list describes the files:

- SYS1.LINKLIB(BPXMBATC) is the BPXBATCH program location.
- The stdin default is /dev/null.
- The stdout default is /dev/null.
- The stderr default is /dev/null.
- The stderr default is the value of stdout. If all defaults are accepted, stderr is /dev/null.





---

## Chapter 19. `as` — Use the HLASM assembler to produce object files

---

### Format

```
as
    [--option[, option] ...] ...
    [-a[egimrsx][=file]] ...
    [--[no]gadata[=file]]
    [-moption]
    [-I PDS]
    [-o objectfile]
    [-v]
    [--[no]help]
    [--[no]verbose]
file
```

---

### Description

The `as` command processes assembler source files and invokes the HLASM assembler to produce object files.

---

### Options

- `--` Accepts all options that are accepted by HLASM. Multiple options can be specified by separating them with a comma. This style of option specification is designed to provide smooth migration for users accustomed to specifying options in JCL. For example:  
`--"FLAG(ALIGN),RENT"`
- `-a[egimrsx][=file]` Instructs the assembler to produce a listing.
- `-ae` Instructs the assembler to produce the External Symbol Dictionary section of the assembler listing. This is equivalent to specifying: `--ESD`.
- `-ag` Instructs the assembler to produce the General Purpose Register Cross Reference section of the assembler listing. This is equivalent to specifying: `--RXREF`.
- `-ai` Instructs the assembler to copy all product information to the list data set. This is equivalent to specifying: `--INFO`.
- `-am` Instructs the assembler to produce the Macro and Copy Code Source Summary section of the assembler listing. This is equivalent to specifying: `--MXREF`.
- `-ar` Instructs the assembler to produce the Relocation Dictionary (RLD) section of the assembler listing. This is equivalent to specifying: `--RLD`.
- `-as` Instructs the assembler to produce the Ordinary Symbol and Literal Cross Reference section of the assembler listing. It also instructs the assembler to produce the un-referenced symbols defined in the CSECTs section of the assembler listing. This is equivalent to specifying: `--XREF(SHORT,UNREFS)`.

## as

|           **-ax**     Instructs the assembler to produce the DSECT Cross Reference  
|                    section of the assembler listing. This is equivalent to specifying:  
|                    --DXREF.  
|  
|            **=file**    Specifies the file name of the listing output. If you do not specify a  
|                    file name, the output goes to stdout.

|            You may combine these options; for example, use **-ams** for an assembly  
|            listing with expanded macro and symbol output. The **=file** option, if used,  
|            must be specified last.

### |            **--[no]gadata[=file]**

|            Instructs the assembler to collect associated data and write it to the  
|            associated data file. You can optionally specify the name of the output  
|            debug file. The specified name cannot be a PDS or z/OS UNIX file system  
|            directory name. If you do not specify a file name, the default name is  
|            created as follows:

- |            • If you are compiling a data set, the **as** command uses the source file  
|            name to form the name of the output data set. The high-level qualifier is  
|            replaced with the user ID under which the **as** command is running, and  
|            .ADATA is appended as the low-level qualifier. For example, if TS12345 is  
|            compiling TSMYID.MYSOURCE(src) with this option, the produced debug file  
|            name will be TS12345.MYSOURCE.ADATA(src).
- |            • If you are compiling a z/OS UNIX file, the **as** command stores the debug  
|            information in a file that has the name of the source file with an .ad  
|            extension. For example, if you are compiling src.a with this option, the  
|            compiler will create a debug file named src.ad.

### |            **-moption**

|            HLASM keyword options are specified using the following syntax:

|            -m<option>[=<parm>[=<value>]][:<parm>[=<value>]]...

|            where <option> is an option name, <parm> is a suboption name, and  
|            <value> is the suboption value.

|            Keyword options with no parameters represent switches that may be either  
|            on or off. The keyword by itself turns the switch on, and the keyword  
|            preceded by the letters NO turns the switch off. For example, **-mLIST** tells  
|            the HLASM assembler to produce a listing and **-mNOLIST** tells the HLASM  
|            assembler not to produce a listing. If an option that represents a switch is  
|            set more than once, the HLASM assembler uses the last setting.

|            Keyword option and parameter names may appear in mixed case letters in  
|            the invocation command.

### |            **--[no]help**

|            Help menu. Displays the syntax of the **as** command.

|            **-I PDS**    Instructs HLASM to look for assembler macro invocation in the specified  
|            location. The PDS data set specified must be fully qualified. The specified  
|            locations are then prepended to a default set of macro libraries. The **as**  
|            command assumes a default set of macro libraries that is compatible with  
|            the defaults for the C/C++ compilers. The default data sets used are: -I  
|            CEE.SCEEMAC, -I SYS1.MACLIB, and -I SYS1.MODGEN. The default  
|            data sets can be changed via the environment variable `_AS_MACLIB`, for  
|            example:

|            export `_AS_MACLIB="FIRST.PDS:SECOND.PDS"`

**-o** *objectfile*

Specifies the name of the object file. If the name specified is a PDS or z/OS UNIX System Services directory name, a default file name is created in the PDS or z/OS UNIX directory specified as follows:

- If the source file is a sequential data set, the second last part of the data set name will be used. If the data set name only contains one part after the high-level qualifier, then the last part will be used.
- If the source file is a PDS member, the member name will be used.
- If the source file is a z/OS UNIX file, the suffix will be removed if applicable.
- If the object file is going into a PDS, the first eight characters of the name will be used. If there is a dot, anything after the first dot will be removed.
- If the object file is going into a z/OS UNIX directory, .o will be appended to the name.

For example:

```
Source file: //'abc.hello.source'
Output file in PDS: HELLO
Output file in UNIX directory: hello.o
```

```
Source file: //'ABC.HELLO'
Output file in PDS: HELLO
Output file in UNIX directory: HELLO.o
```

```
Source file: //SOURCE(hello)
Output file in PDS: HELLO
Output file in UNIX directory: hello.o
```

```
Source file: /abc/hello.s
Output file in PDS: HELLO
Output file in UNIX directory: hello.o
```

```
Source file: /abc/hellothere.s
Output file in PDS: HELLOTHE
Output file in UNIX directory: hellothere.o
```

**-v** Writes the version of the **as** command to stderr.

**--[no]verbose**

Specifies verbose mode, which writes additional information messages to stdout.

**file** may be:

- An MVS data set (for example, //somenam)
- An absolute z/OS UNIX file (for example, /somenam)
- A relative z/OS UNIX file (for example, ./somenam or somenam)

The output of the **as** command is an object file. If you do not specify a file name via the **-o** option, the default name is created as follows:

- If you are compiling a data set, the **as** command uses the source file name to form the name of the output data set. The high-level qualifier is replaced with the user ID under which the **as** command is running, and .OBJ is appended as the low-level qualifier. For example, if TS12345 is compiling TSMYID.MYSOURCE(src), the compiler will create an object file named TS12345.MYSOURCE.OBJ(src).
- If you are compiling a z/OS UNIX file, the **as** command names the object file with the name of the source file with an .o extension. For example, if you are compiling src.a, the object file name will be src.o.

## as

### Notes:

1. The **as** command does not accept standard input as a file.
2. The **as** command invokes the HLASM assembler to produce the object file. The HLASM assembler is invoked with the default options ASA and TERM. The ASA option instructs HLASM to use American National Standard printer control characters in records written to the listing file, thus making the listing file more readable in the UNIX System Services environment. The TERM option instructs HLASM to write error messages to stderr. These defaults can be changed by using the **-m** option or **--** option.
3. HLASM messages and **as** error messages are directed to stderr. Verbose option output is directed to stdout.
4. When invoking **as** from the shell, any option arguments or operands specified that contain characters with special meaning to the shell must be escaped. For example, source files specified as PDS member names contain parentheses; if they are specified as fully qualified names, they contain single quotes. To escape these special characters, either enclose the option argument or operand in double quotes, or precede each character with a backslash.

## Chapter 20. c89 — Compiler invocation using host environment variables

### Format

```
c89 | cc | c++ | cxx [-+CcEFfgOpqrsVv0123]
    [-D name[=value]]... [-U name]...
    [-e function] [-u function]...
    [-W phase,option[,option]]...
    [-o outfile]
    [-I directory]... [-L directory]...
    [file.C]... [file.I]... [file.c]... [file.s]...
    [file.o]... [file.x]... [file.p]... [file.l]... [file.a]... [-l libname]...
```

#### Notes:

1. The **I** option signifies an uppercase *i*, not a lowercase *L*.
2. The **c99** command is only supported by the `xlc` utility. See Chapter 21, “`xlc` — Compiler invocation using a customizable configuration file,” on page 527 for more information.

### Description

**c89** and **cc** compile, assemble, and link-edit C programs; **cxx/c++** does the same for C++ programs.

- **c89** should be used when compiling C programs that are written according to *Standard C*.
- **cc** should be used when compiling C programs that are written according to *Common Usage C*.
- **cxx/c++** must be used when compiling C++ programs. Prior to z/OS V1R2, the C++ compiler supported the *Draft Proposal International Standard for Information Systems — Programming Language C++ (X3J16)*. As of z/OS V1R7, the C++ compiler supports the *Programming languages - C++ (ISO/IEC 14882:2003(E))* standard, as well as the *Programming languages - C++ (ISO/IEC 14882:1998)* standard. **c++** can compile both C++ and C programs, and can also be invoked by the name **cxx** (all references to **c++** throughout this document apply to both names).

**c89**, **cc**, and **c++** call other programs for each step of the compilation, assemble and link-editing phases. The list below contains the following: the step name, the name of the document that describes the program you use for that step and the document that describes any messages issued by that program, and prefixes to those messages:

Table 44. Reference documentation for programs invoked by `c89`, `cc`, and `c++` commands

| Step Name | Document Describing Options and How to Call Program | Document Containing Messages Issued by Program | Prefix of Messages Issued by Program |
|-----------|---|--|--------------------------------------|
| ASSEMBLE  | <i>HLASM Programmer's Guide</i>                     | <i>HLASM Programmer's Guide</i>                | ASMA                                 |

Table 44. Reference documentation for programs invoked by c89, cc, and c++ commands (continued)

| Step Name                                   | Document Describing Options and How to Call Program   | Document Containing Messages Issued by Program   | Prefix of Messages Issued by Program |
|---|---|--|--------------------------------------|
| COMPILE, IPACOMP, TEMPINC, IPATEMP, IPALINK | <i>z/OS C/C++ User's Guide</i> for releases prior to z/OS V1R7 and <i>z/OS XL C/C++ User's Guide</i> for z/OS V1R7 and later releases | <i>z/OS C/C++ Messages</i> for z/OS V1R5 and z/OS V1R6 releases and <i>z/OS XL C/C++ Messages</i> for z/OS V1R7 and later releases | CCN for z/OS V1R2 and later releases |
| PRELINK                                     | <i>z/OS Language Environment Programming Guide</i> and <i>z/OS XL C/C++ User's Guide</i>  | <i>z/OS Language Environment Debugging Guide</i>   | EDC                                  |
| LINKEDIT (Program Management Binder)        | <i>z/OS MVS Program Management: User's Guide and Reference</i>  | <i>z/OS MVS System Messages, Vol 8 (IEF-IGD)</i>   | IEW                                  |

Execution of any Language Environment program (including c89 and the z/OS XL C/C++ compiler) can result in run-time messages. These messages are described in *z/OS Language Environment Run-Time Messages* and have an EDC prefix. In some cases, c89 issues messages with Language Environment messages appended to them. Messages issued by c89 have an FSUM3 prefix.

In order for **c89**, **cc**, and **c++** to perform C and C++ compiles, the z/OS C/C++ Optional Feature must be installed on the system. The z/OS C/C++ Optional Feature provides a C compiler, a C++ compiler, C++ Class Libraries, and some utilities. See *z/OS Introduction and Release Guide* for further details. Also see *prefix\_CLIB\_PREFIX* and *prefix\_PLIB\_PREFIX* in “Environment variables” on page 504 for information about the names of the z/OS XL C/C++ Optional Feature data sets that must be made available to **c89/cc/c++**.

**Note:** The term *prefix* is defined in “Environment variables” on page 504.

First, **c89**, **cc**, and **c++** perform the compilation phase (including preprocessing) by compiling all source file operands (*file.C*, *file.i*, and *file.c*, as appropriate). For **c++**, if automatic template generation is being used (which is the default), then z/OS XL C++ source files may be created or updated in the tempinc subdirectory of the working directory during the compilation phase (the tempinc subdirectory will be created if it does not already exist). Then, **c89**, **cc**, and **c++** perform the assemble phase by assembling all operands of the *file.s* form. The result of each compile step and each assemble step is a *file.o* file. If all compilations and assemblies are successful, or if only *file.o* and/or *file.a* files are specified, **c89**, **cc**, and **c++** proceed to the link-editing phase. For **c++**, the link-editing phase begins with an automatic template generation step when applicable. For IPA (Interprocedural Analysis) optimization an additional IPA Link step comes next. The link-edit step is last. See

the environment variable *prefix\_STEPS* under “Environment variables” on page 504 for more information about the link-editing phase steps.

In the link-editing phase, **c89**, **cc**, and **c++** combine all *file.o* files from the compilation phase along with any *file.o* files that were specified on the command line. For **c++**, this is preceded by compiling all z/OS XL C++ source files in the `tempinc` subdirectory of the working directory (possibly creating and updating additional z/OS XL C++ source files during the automatic template generation step). After compiling all the z/OS XL C++ source files, the resulting object files are combined along with the *file.o* files from the compilation phase and the command line. Any *file.a* files, *file.x* files and **-l** *libname* operands that were specified are also used.

The usual output of the link-editing phase is an executable file. For **c89**, **cc**, and **c++** to produce an executable file, you must specify at least one operand which is of other than **-l** *libname* form. If **-r** is used, the output file is not executable.

For more information about automatic template generation, see the information on “Using TEMPINC or NOTEMPINC” in *z/OS XL C/C++ Programming Guide*. Note that the **c++** command only supports using the `tempinc` subdirectory of the working directory for automatic template generation.

IPA is further described under the **-W** option on page 499.

---

## Options

- +** Specifies that all source files are to be recognized as C++ source files. All *file.s*, *file.o*, and *file.a* files will continue to be recognized as assembler source, object, and archive files respectively. However, any C *file.c* or *file.i* files will be processed as corresponding C++ *file.C* or *file.i* files, and any other file suffix which would otherwise be unrecognized will be processed as a *file.C* file.  
  
This option effectively overrides the environment variable *prefix\_EXTRA\_ARGS*. This option is only supported by the **c++** command.
- C** Specifies that C and C++ source comments should be retained by the preprocessor. By default, all comments are removed by the preprocessor. This option is ignored except when used with the **-E** option.
- c** Specifies that only compilations and assemblies be done. Link-edit is not done.
- D name[=value]** Defines a C or C++ macro for use in compilation. If only *name* is provided, a value of 1 is used for the macro it specifies. For information about macros that **c89/cc/c++** automatically define, see Usage Note 5 on page 519. Also see Usage Note 13 on page 521.  
  
**Note:** The `xlC` utility has slightly different semantics for processing **-D** options.
- E** Specifies that output of the compiler preprocessor phase be copied to `stdout`. Object files are not created, and no link-editing is performed.
- e function** Specifies the name of the function to be used as the entry point of the program. This can be useful when creating a fetchable program, or a non-C or non-C++ main, such as a COBOL program. Non-C++ linkage symbols



of up to 1024 characters in length may be specified. You can specify an S-name by preceding the function name with double slash (/). (For more information about S-names, see Usage Note 23 on page 524.)

Specify a null S-name ("-e //") so that no function name is identified by **c89/cc/c++** as the entry point of the program. In that case, the Program Management Binder (link editor) default rules will determine the entry point of the program. For more information about the Program Management Binder and the ENTRY control statement, see *z/OS MVS Program Management: User's Guide and Reference*.

The function `//ceestart` is the default. When the default function entry point is used, a binder ORDER control statement is generated by **c89/cc/c++** to cause the CEESTART code section to be ordered to the beginning of the program. Specify the name with a trailing blank to disable this behavior, as in `//ceestart` . For more information about the Program Management Binder and the ORDER control statement, see *z/OS MVS Program Management: User's Guide and Reference*.

This option may be required when building products which are intended to be installed using the IBM SMP/E product. When installing ++MOD elements with SMP/E, binder control statements should be provided in the JCLIN created to install the product instead of being embedded in the elements themselves.

- F** Ignored by **cc**. Provided for compatibility with historical implementations of **cc**. Flagged as an error by **c89** and **c++**.
- f** Ignored by **cc**. Provided for compatibility with historical implementations of **cc**. Flagged as an error by **c89** and **c++**.

Historical implementations of C/C++ used this option to enable floating-point support. Floating-point is automatically included in z/OS XL C/C++. However, in z/OS XL C/C++, two types of floating-point support are available:

#### **HEXADECIMAL**

Base 16 IBM System z9 hexadecimal format. The IBM System z9 hexadecimal format is referred to as the hexadecimal floating-point format, and is unique to IBM System z9 hardware. This is the default.

#### **IEEE754**

Base 2 IEEE-754 binary format. The IEEE-754 binary format is referred to as binary floating-point format. The IEEE-754 binary format is the more common floating point format used on other platforms.

If you are porting an application from another platform, transmitting floating-point numbers between other platforms or workstations, or your application requires the larger exponent range provided by IEEE-754 binary format, then you should consider using IEEE floating-point.

**Example:** The following is an example of compiling with IEEE-754 binary floating point format:

```
c89 -o outfile -Wc,'float(ieee)' file.c
```

- g** Specifies that a side file that contains symbolic information is emitted and the executable is to be loaded into read/write storage, which is required for source-level debugging with dbx, and other debuggers.



For 32-bit compiles, if the `_DEBUG_FORMAT=ISD` environment variable is exported, then `-g` specifies that the output file (executable) is to contain symbolic information and is to be loaded into read/write storage, which is required for source-level debugging with dbx, and other debuggers.

When specified for the compilation phase, the compiler produces symbolic information for source-level debugging.

When specified for the link-editing phase, the executable file is marked as being serially reusable and will always be loaded into read/write storage.

dbx requires that all the executables comprising the process be loaded into read/write storage so that it can set break points in these executables. When dbx is attached to a running process, this cannot be guaranteed because the process was already running and some executables were already loaded. There are two techniques that will guarantee that all the executables comprising the process are loaded into read-write storage:

1. Specify the `-g` option for the link-editing phase of each executable. After this is done, the executable is always loaded into read/write storage.

Because the executable is marked as being serially reusable, this technique works except in cases where the executable must be marked as being reentrant. For example:

- If the executable is to be used by multiple processes in the same user space.
- If the executable is a DLL that is used on more than one thread in a multithreaded program.

In these cases, use the following technique instead:

2. Do not specify the `-g` option during the link-editing phase so that the executable will be marked as being reentrant. Before invoking the program, export the environment variable `_BPX_PTRACE_ATTACH` with a value of YES. After you do this, then executables will be loaded into read/write storage regardless of their reusability attribute.

If you compile an MVS data set source using the `-g` option, you can use dbx to perform source-level debugging for the executable file. You must first issue the `dbx use` subcommand to specify a path of double slash (`//`), causing dbx to recognize that the symbolic name of the primary source file is an MVS data set. For information on the `dbx` command and its use subcommand, see *z/OS UNIX System Services Command Reference*.

For more information on using dbx, see *z/OS UNIX System Services Programming Tools*.

The z/OS UNIX System Services web page also has more information about dbx. Go to [www.ibm.com/servers/eserver/zseries/zos/unix/](http://www.ibm.com/servers/eserver/zseries/zos/unix/).

For more information on the `_BPX_PTRACE_ATTACH` environment variable, see *z/OS UNIX System Services Programming: Assembler Callable Services Reference*.

The GONUMBER option is automatically turned on by the `-g` option, but can also be turned on independently. There is no execution path overhead incurred for turning on this option, only some additional space for the saved line number tables.

For 31-bit compiles and In Storage Debug (ISD) information, the GONUMBER option generates tables that correspond to the input source file line numbers. These tables make it possible for Debug Tools and for error trace back information in CEE dumps to display the source line numbers. Having source line numbers in CEE dumps improves serviceability costs of applications in production.

**Example:** The following is an example of compiling with the GONUMBER compiler option:

```
c89 -o outfile -Wc,'GONUM' file.c
```

**Note:** **-g** forces the NOOPTIMIZE compiler option regardless of its position in the command line.

### **-I** *directory*

**Note:** The I option signifies an uppercase i, not a lowercase L.

**-I** specifies the directories to be used during compilation in searching for include files (also called header files).

Absolute pathnames specified on `#include` directives are searched exactly as specified. The directories specified using the **-I** option or from the usual places are not searched.

If absolute pathnames are not specified on `#include` directives, then the search order is as follows:

1. Include files enclosed in double quotes (") are first searched for in the directory of the file containing the `#include` directive. Include files enclosed in angle-brackets (< >) skip this initial search.
2. The include files are then searched for in all directories specified by the **-I** option, in the order specified.
3. Finally, the include files are searched for in the usual places. (See Usage Note 4 on page 519 for a description of the usual places.)

You can specify an MVS data set name as an include file search directory. Also, MVS data set names can explicitly be specified on `#include` directives. You can indicate both by specifying a leading double slash (//).

**Example:** To include the include file DEF that is a member of the MVS PDS ABC.HDRS, code your C or C++ source as follows:

```
#include < //'abc.hdrs(def) '>
```

MVS data set include files are handled according to z/OS XL C/C++ compiler conversion rules (see Usage Note 4 on page 519). When specifying an `#include` directive with a leading double slash (in a format other than `#include < //'dsname' >` and `#include < //dd:ddname >`), the specified name is paired only with MVS data set names specified on the **-I** option. That is, when you explicitly specify an MVS data set name, any z/OS UNIX file system directory names specified on the **-I** option are ignored.

### **-L** *directory*

Specifies the directories to be used to search for archive libraries specified by the **-I** operand. The directories are searched in the order specified, followed by the usual places. You cannot specify an MVS data set as an archive library directory.

For information on specifying C370LIB libraries, see the description of the `-l libname` operand. Also see Usage Note 7 on page 520 for a description of the usual places.

### **-O, -O (-1), -2, -3**

Specifies the level of compiler optimization (including inlining) to be used. The level -1 (number one) is equivalent to -O (capital letter O). The level -3 gives the highest level of optimization. The default is -O (level zero), no optimization and no inlining, when not using IPA (Interprocedural Analysis).

When optimization is specified, the default is ANSIALIAS. The ANSIALIAS default specifies whether type-based aliasing is to be used during optimization. That is, the optimizer assumes that pointers can only be used to access objects of the same type. Type-based aliasing improves optimization. Applications that use pointers that point to objects of a different type will need to specify NOANSIALIAS when the optimization compiler option is specified. If your application works when compiled with no optimization and fails when compiled with optimization, then try compiling your application with both optimization and NOANSIALIAS compiler options.

#### **Notes:**

1. Options can also be specified as -O1 (using capital letter O), -O2, and -O3. For further information, see Usage Note 12 on page 521.
2. These options cannot be overridden by specifying optimization options using the **-Wc** syntax. This behavior differs from the behavior of the xlc utility, which allows the use of **-q** and **-Wc** syntax to override the flag optimization options.

**Example:** The following is an example of a compile with the highest level of optimization and no type-based aliasing:

```
c89 -o outfile -O3 -Wc,NOANSIALIAS file.c
```

When optimization is specified, you may want to obtain a report on the amount of inlining performed and increase or decrease the level of inlining. More inlining will improve application performance and increase application memory usage.

**Example:** The following is an example of a compile with optimization with no report generated, a threshold of 500 abstract code units, and a limit of 2500 abstract code units:

```
c89 -o outfile -O2 -Wc,'inline(auto,noreport,500,2500)' file.c
```

When using IPA, the default is -O (level 1) optimization and inlining. IPA optimization is independent from and can be specified in addition to this optimization level. IPA is further described under the -W option on page 499.

If compiling with PDF, the same optimization level must be used in the PDF1 and PDF2 steps.

If you compile your program to take advantage of **dbx** source-level debugging and specify `-g` (see the **-g** option on page 492), you will always get -O (level zero) optimization regardless of which of these compiler optimization levels you specify.

In addition to using optimization techniques, you may want to control writable strings by using the **#pragma strings(readonly)** directive or the ROSTRING compiler option. As of z/OS Version 1 Release 2, ROSTRING is the default.

For more information on this topic, refer to the chapter on reentrancy in z/OS XL C/C++ in *z/OS XL C/C++ Programming Guide* or the description of “ROSTRING | NOROSTRING” on page 181.

**-o** *outfile*

Specifies the name of the **c89/cc/c++** output file.

If the **-o** option is specified in addition to the **-c** option, and only one source file is specified, then this option specifies the name of the output file associated with the one source file. See *file.o* under “Operands” on page 502 for information on the default name of the output file.

Otherwise the **-o** option specifies the name of the executable file produced during the link-editing phase. The default output file is **a.out**.

**-p** Ignored by **cc**. Provided for compatibility with historical implementations of **cc**. Flagged as an error by **c89** and **c++**.

**-q** Ignored by **cc**. Provided for compatibility with historical implementations of **cc**. Flagged as an error by **c89** and **c++**.

**-r** Specifies that **c89/cc/c++** is to save relocation information about the object files which are processed. When the output file (as specified on **-o**) is created, it is not made an executable file. Instead, this output file can later be used as input to **c89/cc/c++**. This can be used as an alternative to an archive library.

**IPA Usage Note:**

When using **-r** and link-editing IPA compiled object files, you must link-edit with IPA (see the description of IPA under the **-W** option). However, the **-r** option is typically not useful when creating an IPA optimized program. This is because link-editing with IPA requires that all of the program information is available to the link editor (that is, all of the object files). It is not acceptable to have unresolved symbols, especially the program entry point symbol (which is usually `main`). The **-r** option is normally used when you wish to combine object files incrementally. You would specify some object files during the initial link-edit that uses **-r**. Later, you would specify the output of the initial link-edit, along with the remaining object files in a final link-edit that is done without using **-r**. In such situations where you wish to combine IPA compiled object files, there is an alternative which does not involve the link editor. That alternative is to concatenate the object files into one larger file. This larger file can later be used in a final link-edit, when the remainder of the object files are also made available. (This concatenation can easily be done using the **cp** or **cat** utilities.)

**-s** Specifies that the compilation phase is to produce a *file.o* file that does *not* include symbolic information, and that the link-editing phase produce an executable that is marked reentrant. This is the default behavior for **c89/cc/c++**.

**-U** *name*

Undefines a C or C++ macro specified with *name*. This option affects only macros defined by the **-D** option, including those automatically specified by

**c89/cc/c++.** For information about macros that **c89/cc/c++** automatically define, see Usage Note 5 on page 519. Also see Usage Note 13 on page 521.

**Note:** The xlc utility uses different semantics for handling the -U option. See Chapter 21, “xlc — Compiler invocation using a customizable configuration file,” on page 527 for more information.

**-u function**

Specifies the name of the function to be added to the list of symbols which are not yet defined. This can be useful if the only input to **c89/cc/c++** is archive libraries. Non-C++ linkage symbols of up to 255 characters in length may be specified. You can specify an S-name by preceding the function name with double slash (//). (For more information about S-names, see Usage Note 23 on page 524.) The function //ceemain is the default for non-IPA Link-editing, and the function main is the default for IPA Link-editing. However, if this -u option is used, or the DLL link editor option is used, then the default function is not added to the list.

**-V** This verbose option produces and directs output to stdout as compiler, assembler, IPA linker, prelinker, and link editor listings. If the -O, -2, or -3 options are specified and cause **c89/cc/c++** to use the compiler INLINE option, then the inline report is also produced with the compiler listing. Error output continues to be directed to stderr. Because this option causes **c89/cc/c++** to change the options passed to the steps producing these listings so that they produce more information, it may also result in additional messages being directed to stderr. In the case of the compile step, it may also result in the return code of the compiler changing from 0 to 4.

**Note:** This option has a different meaning when using the xlc utility. See Chapter 21, “xlc — Compiler invocation using a customizable configuration file,” on page 527 for more information.

**-v** This verbose option causes pseudo-JCL to be written to stdout before the compiler, assembler, IPA linker, prelinker, and link editor programs are run.

**Example:** It also causes phaseid information to be emitted in stderr:

```
FSUM0000I Utility(c89)                               Level(UQ99999)
```

It provides information about exactly which compiler, prelinker, and link editor options are being passed, and also which data sets are being used. If you want to obtain this information without actually invoking the underlying programs, specify the -v option more than once on the **c89/cc/c++** command string. For more information about the programs which are executed, see Usage Note 14 on page 521.

**-W phase, option[,option]...**

Specifies options to be passed to the steps associated with the compile, assemble, or link-editing phases of **c89/cc/c++**. The valid phase codes are:

**0** Specifies the compile phase (used for both non-IPA and IPA compilation).

**a** Specifies the assemble phase.

**c** Same as phase code 0.

**l** Enables IPA (Interprocedural Analysis) optimization.

Unlike other phase codes, the IPA phase code `I` does not require that any additional options be specified, but it does allow them. In order to pass IPA suboptions, specify those suboptions using the IPA phase code.

**Example:** To specify that an IPA Compile should save source line number information, without writing a listing file, specify:

```
c89 -c -W I,list file.c
```

**Example:** To specify that an IPA Link-edit should write the map file to `stdout`, specify:

```
c89 -W I,map file.o
```

**1** Specifies the link-editing phase.

- To pass options to the prelinker, the first link-editing phase option must be `p` or `P`. All the following options are then prelink options.

**Example:** To write the prelink map to `stdout`, specify:

```
c89 -W l,p,map file.c
```

**Note:** The prelinker is no longer used in the link-editing phase in most circumstances. If it is not used, any options passed are accepted but ignored. See the environment variable `prefix_STEPS` under “Environment variables” on page 504 for more information about the link-editing phase prelink step.

- To pass options to the IPA linker, the first link-editing phase option must be `i` or `I`. All the following options are then IPA Link options.

**Example:** To specify the size of the SPILL area to be used during an IPA Link-edit, you could specify:

```
c89 -W l,I,"spill(256)" file.o
```

- To link-edit a DLL (Dynamic Link Library) and produce a side deck, the link-editing phase option `DLL` must be specified.

**Example:** To accomplish this task, you could specify:

```
c89 -o outdll -W l,dll file.o
```

Most z/OS XL C/C++ extensions can be enabled by using this option. Those which do not directly pass options through to the underlying steps, or involve files which are extensions to the compile and link-edit model, are described here:

### DLL (Dynamic Link Library)

A DLL is a part of a program that is not statically bound to the program. Instead, linkage to symbols (variables and functions) is completed dynamically at execution time. DLLs can improve storage utilization, because the program can be broken into smaller parts, and some parts may not always need to be loaded. DLLs can improve maintainability, because the individual parts can be managed and serviced separately.

In order to create a DLL, some symbols must be identified as being exported for use by other parts of the program. This can be done with the z/OS XL C/C++ `#pragma export` compiler directive, or by using the z/OS XL C/C++ `EXPORTALL` compiler option. If during the link-editing phase some of the parts have exported symbols, the executable which is created is a DLL. In addition to the DLL, a definition side-deck is created, containing link-editing phase



IMPORT control statements which name those symbols which were exported by the DLL. In order for the definition side-deck to be created, the DLL link editor option must be specified. This definition side-deck is subsequently used during the link-editing phase of a program which is to use the DLL. See the *file.x* operand under Operands on page 504 for information on where the definition side-deck is written. In order for the program to refer to symbols exported by the DLL, it must be compiled with the DLL compiler option.

**Example:** To compile and link a program into a DLL, you could specify:

```
c89 -o outdll -W c,exportall -W l,dll file.c
```

To subsequently use *file.x* definition side-decks, specify them along with any other *file.o* object files specified for **c89/cc/c++** link-editing phase.

**Example:** To accomplish this task, you could specify:

```
c89 -o myappl -W c,dll myappl.c outdll.x
```

In order to run an application which is link-edited with a definition side-deck, the DLL must be made available (the definition side-deck created along with the DLL is not needed at execution time). When the DLL resides in the z/OS UNIX file system, it must be in either the working directory or in a directory named on the LIBPATH environment variable. Otherwise it must be a member of a data set in the search order used for MVS programs.

**Note:** For non-DLL C++ compiles, a dummy definition side file will be allocated to prevent the binder from issuing a warning message. If you do want the binder to issue a warning message when an exported symbol is encountered, specify the DLL=NO option for the link-editing phase; for example:

```
c++ -o outfile -W l,dll=no file.C
```

### IPA (interprocedural analysis)

IPA optimization is independent from and can be used in addition to the **c89/cc/c++** optimization level options (such as `-O`). IPA optimization can also improve the execution time of your application. IPA is a mechanism for performing optimizations across function boundaries, even across compilation units. It also performs optimizations not otherwise available with the z/OS XL C/C++ compiler.

When phase code I (capital letter I) is specified for the compilation phase, then IPA compilation steps are performed. When phase code I is specified for the link-editing phase, or when the first link-editing phase (code I) option is `i` or `I`, then an additional IPA Link step is performed prior to the prelink and link-edit steps.

With conventional compilation and link-editing, the object code generation takes place during the compilation phase. With IPA compilation and link-editing, the object code generation takes place during the link-editing phase. Therefore, you might need to request listing information about the program (such as with the `-V` option) during the link-editing phase.

Unlike the other phase codes, phase code I does not require that any additional options be specified. If they are, they should be specified for both the compilation and link-editing phases.

No additional preparation needs to be done in order to use IPA.

**Example:** To create the executable myIPApgm using c89 with some existing source program mypgm.c, you could specify:

```
c89 -W I -o myIPApgm mypgm.c
```

When IPA is used with **c++**, and automatic template generation is being used, phase code I will control whether the automatic template generation compiles are done using IPA. If you do not specify phase code I, then regular compiles will be done. Specifying I as the first option of the link-editing phase option (that is, **-W I,I**), will cause the IPA linker to be used, but will not cause the IPA compiler to be used for automatic template generation unless phase code I (that is, **-W I**) is also specified.

The IPA Profile-Directed Feedback (PDF) option tunes optimizations, where results from sample program execution are used to improve optimization near conditional branches and in frequently executed code sections. The profiling information is placed in the file specified by the PDFNAME(filename) suboption. If PDFNAME(filename) is not specified, the default name of the file containing profile information is PDF.

**LP64** The LP64 option instructs the compiler to generate AMODE 64 code utilizing the z/Architecture 64-bit instructions.

To compile 64-bit code, specify the z/OS XL C/C++ LP64 compiler option.

**Example:** The following example shows how to compile and bind using the LP64 option:

```
c89 -o -W c,LP64 -W1,LP64 file.c
```

### **XPLINK (Extra Performance Linkage)**

z/OS XPLINK provides improved performance for many C/C++ programs. The XPLINK compiler option instructs the z/OS XL C/C++ compiler to generate high performance linkage for subroutine calls. It does so primarily by making subroutine calls as fast and efficient as possible, by reducing linkage overhead, and by passing function call parameters in registers. Furthermore, it reduces the data size by eliminating unused information from function control blocks.

An XPLINK-compiled program is implicitly a DLL-compiled program (the C/C++ DLL compiler option need not be specified along with the XPLINK option). XPLINK improves performance when crossing function boundaries, even across compilation units, since XPLINK uses a more efficient linkage mechanism.

For more information about Extra Performance Linkage, refer to *z/OS Language Environment Programming Guide*.

To use XPLINK, you must both compile and link-edit the program for XPLINK. All C and C++ source files must be compiled XPLINK, as you cannot statically link together XPLINK and non-XPLINK C and C++ object files (with the exception of non-XPLINK "OS"



linkage). You can however mix XPLINK and non-XPLINK executables across DLL and fetch() boundaries.

To compile a program as XPLINK, specify the z/OS XL C/C++ XPLINK compiler option. If there are any exported symbols in the executable and you want to produce a definition side-deck, specify the DLL link editor option. When XPLINK is specified in the link-editing step, different link-edit libraries will be used.

**Example:** Here is an example of compiling and link-editing an XPLINK application in one command:

```
c89 -o outxpl -W c,XPLINK -W l,XPLINK,dll file.c
```

In order to execute an XPLINK program, the SCEERUN2 as well as the SCEERUN data set must be in the MVS program search order (see the *prefix\_PLIB\_PREFIX* environment variable).

You cannot use `-W` to override the compiler options that correspond to **c89/cc/c++** options, with the following exceptions:

- Listing options (corresponding to `-V`)
- Inlining options (corresponding to `-O`, `-2`, and `-3`)
- Symbolic options (corresponding to `-s` and `-g`); symbolic options can be overridden only when neither `-s` nor `-g` is specified.

**Notes:**

1. Most compiler, prelinker, and IPA linker options have a positive and negative form. The negative form is the positive with a prepended NO (as in XREF and NOXREF).
2. The compiler **#pragma options** directives as well as any other #pragma directives which are overridden by compiler options, will have no effect in source code compiled by **c89/cc/c++**.
3. Link editor options must be specified in the *name=value* format. Both the option *name* and *value* must be spelled out in full. If you do not specify a value, a default value of YES is used, except for the following options, which if specified without a value, have the default values shown here:

|                |               |
|----------------|---------------|
| <b>ALIASES</b> | ALIASES=ALL   |
| <b>DYNAM</b>   | DYNAM=DLL     |
| <b>LET</b>     | LET=8         |
| <b>LIST</b>    | LIST=NOIMPORT |

**Notes:**

- a. The binder default is COMPAT=MIN. For downward compatibility (when `-Wc, 'target(release)'` is used), COMPAT should also be used (for example, `-Wl, compat=min`, or the specific program object format level supported by the target deployment system, if it is known). For more information, see “z/OS Language Environment downward compatibility” on page 10.
- b. As of z/OS V1R8, the default for the COMPAT option is no longer emitted by the c89 utility. In prior releases, the default was COMPAT=CURRENT.
- c. References throughout this document to the link editor are generic references. **c89/cc/c++** specifically uses the Program Management binder for this function.

4. Related information about the z/OS XL C/C++ run-time library, including information about DLL and IPA support, is described in *z/OS XL C/C++ Programming Guide*. Related information about the C and C++ languages, including information about compiler directives, is described in *z/OS XL C/C++ Language Reference*.
5. Since some compiler options are only used by z/OS XL C and some compiler options are only used by z/OS XL C++, you may get warning messages and a compiler return code of 4, if you use this option and compile both C and C++ source programs in the same **c++** command invocation.
6. For more information on the prelinker, see Appendix A, “Prelinking and linking z/OS XL C/C++ programs,” on page 549.
7. Any messages produced by it (CCN messages) are documented in *z/OS XL C/C++ Messages*.
8. You may see run-time messages (CEE or EDC) in executing your applications. These messages are described in *z/OS Language Environment Debugging Guide*.
9. The link editor (the Program Management binder) is described in *z/OS MVS Program Management: User’s Guide and Reference*. The Program Management binder messages are described in *z/OS MVS System Messages, Vol 8 (IEF-IGD)*.

---

## Operands

**c89/cc/c++** generally recognize their file operand types by file suffixes. The suffixes shown here represent the default values used by **c89/cc/c++**. See “Environment variables” on page 504 for information on changing the suffixes to be used.

Unlike **c89** and **c++**, which report an error if given an operand with an unrecognized suffix, **cc** determines that it is either an object file or a library based on the file itself. This behavior is in accordance with the environment variable *prefix\_EXTRA\_ARGS*.

- file.a* Specifies the name of an archive file, as produced by the **ar** command, to be used during the link-editing phase. You can specify an MVS data set name, by preceding the file name with double slash (*//*), in which case the last qualifier of the data set name must be *LIB*. The data set specified must be a C370LIB object library or a load library. See the description of the **-l libname** operand for more information about using data sets as libraries.
- file.C* Specifies the name of a C++ source file to be compiled. You can specify an MVS data set name by preceding the file name with double slash (*//*), in which case the last qualifier of the data set name must be *CXX*. This operand is only supported by the **c++** command.
- file.c* Specifies the name of a C source file to be compiled. You can specify an MVS data set name by preceding the file name with double slash (*//*), in which case the last qualifier of the data set name must be *C*. (The conventions formerly used by **c89** for specifying data set names are still supported. See the environment variables *prefix\_OSUFFIX\_HOSTRULE* and *prefix\_OSUFFIX\_HOSTQUAL* for more information.)
- file.l* Specifies the name of a IPA linker output file produced during the **c89/cc/c++** link-editing phase, when the **-W** option is specified with phase code *I*. IPA is further described under the **-W** option on page 499. By default the IPA linker output file is written to a temporary file. To have the IPA linker output file written to a permanent file, see the environment variable *prefix\_TMPS* under Environment variables.

When an IPA linker output file is produced by **c89/cc/c++**, the default name is based upon the output file name. See the **-o** option under Options on page 496, for information on the name of the output file.

If the output file is named *a.out*, then the IPA linker output file is named *a.l*, and is always in the working directory. If the output file is named *//a.load*, then the IPA linker output file is named *//a.IPA*. If the output file specified already has a suffix, that suffix is replaced. Otherwise the suffix is appended. This file may also be specified on the command line, in which case it is used as a file to be link-edited.

*file.i* Specifies the name of a preprocessed C or C++ source file to be compiled. You can specify an MVS data set name, by preceding the file name with double slash (*//*), in which case the last qualifier of the data set name must be *CEX*.

When using the **c++** command, this source file is recognized as a C++ source file, otherwise it is recognized as a C source file. **c++** can be made to distinguish between the two. For more information see the environment variables *prefix\_IXXSUFFIX* and *prefix\_IXXSUFFIX\_HOST*.

*file.o* Specifies the name of a C, C++, or assembler object file, produced by **c89/cc/c++**, to be link-edited.

When an object file is produced by **c89/cc/c++**, the default name is based upon the source file. If the source file is named *file.c*, then the object file is named *file.o*, and is always in the working directory. If the source file were a data set named *//file.C*, then the object file is named *//file.OBJ*.

If the data set specified as an object file has undefined (U) record format, then it is assumed to be a load module. Load modules are not processed by the prelinker.

You can specify an MVS data set name to be link-edited, by preceding the file name with double slash (*//*), in which case the last qualifier of the data set name must be *OBJ*.

**Example:** If a partitioned data set is specified, more than one member name may be specified by separating each with a comma (,):

```
c89 //file.OBJ(mem1,mem2,mem3)
```

*file.p* Specifies the name of a prelinker composite object file produced during the **c89/cc/c++** link-editing phase. By default, the composite object file is written to a temporary file. To have the composite object file written to a permanent file, see the environment variable *prefix\_TMPS* under Environment variables.

When a composite object file is produced by **c89/cc/c++**, the default name is based upon the output file name. See the **-o** option under Options on page 496, for information on the name of the output file.

If the output file is named *a.out*, then the composite object file is named *a.p*, and is always in the working directory. If the output file is named *//a.load*, then the composite object file is named *//a.CPOBJ*. If the output file specified already has a suffix, that suffix is replaced. Otherwise the suffix is appended. This file may also be specified on the command line, in which case it is used as a file to be link-edited.

*file.s* Specifies the name of an assembler source file to be assembled. You can specify an MVS data set name, by preceding the file name with double slash (*//*), in which case the last qualifier of the data set name must be *ASM*.

*file.x* Specifies the name of a definition side-deck produced during the **c89/cc/c++** link-editing phase when creating a DLL (Dynamic Link Library), and used during the link-editing phase of an application using the DLL. DLLs are further described under the **-W** option.

When a definition side-deck is produced by **c89/cc/c++**, the default name is based upon the output file name. See the **-o** option under Options on page 496, for information on the name of the output file.

If the output file is named *a.dll*, then the definition side-deck is named *a.x*, and is always in the working directory. If the output file is named *//a.DLL*, then the definition side-deck is named *//a.EXP*. If the output file specified already has a suffix, that suffix is replaced. Otherwise the suffix is appended.

You can specify an MVS data set name to be link-edited, by preceding the file name with double slash (*//*), in which case the last qualifier of the data set name must be *EXP*.

**Example:** If a partitioned data set is specified, more than one member name may be specified by separating each with a comma (,):

```
c89 //file.EXP(mem1,mem2,mem3)
```

**-l *libname***

Specifies the name of an archive library. **c89/cc/c++** searches for the file *liblibname.a* in the directories specified on the **-L** option and then in the usual places. The first occurrence of the archive library is used. For a description of the usual places, see Usage Note 7 on page 520.

You can also specify an MVS data set; you must specify the full data set name, because there are no rules for searching library directories.

The data set specified must be a C370LIB object library or a load library. If a data set specified as a library has undefined (U) record format, then it is assumed to be a load library. For more information about how load libraries are searched, see Usage Note 7 on page 520.

---

## Environment variables

You can use environment variables to specify necessary system and operational information to **c89/cc/c++**. When a particular environment variable is not set, **c89/cc/c++** uses the default shown. For information about the JCL parameters used in these environment variables, see *z/OS MVS JCL User's Guide*.

Each environment variable has a *prefix* (shown in italics) that should be replaced by one of the following, depending on the command name used:

- *\_CC*
- *\_CXX*
- *\_C89*

This means that to specify **cc** environment variables, the name shown must be prefixed with *\_CC* (for example, *\_CC\_ACCEPTABLE\_RC*). To specify **c89** environment variables, the name shown must be prefixed with *\_C89* (for example, *\_C89\_ACCEPTABLE\_RC*). To specify **c++/cxx** environment variables, the name shown must be prefixed with *\_CXX* (for example, *\_CXX\_ACCEPTABLE\_RC*).

**Notes:**

1. For most environment variables, you can use all three prefixes (`_CC`, `_CXX`, `_C89`). In the list of environment variables that follows, you should assume that all three prefixes can be used unless otherwise indicated.
2. **c89/cc/c++** can accept parameters only in the syntax indicated here. A null value indicates that **c89/cc/c++** should omit the corresponding parameters during dynamic allocation. Numbers in parentheses following the environment variable name correspond to usage notes, which begin on Page 518, and indicate specific usage information for the environment variable.

*prefix\_***ACCEPTABLE\_RC**

The maximum allowed return code (result) of any step (compile, assemble, IPA Link, prelink, or link-edit). If the result is between zero and this value (inclusive), then it is treated internally by **c89/cc/c++** exactly as if it were a zero result, except that message FSUM3065 is also issued. The default value is 4.

When used under **c89/cc/c++**, the prelinker by default returns at least a 4 when there are duplicate symbols or unresolved writable static symbols (but not for other unresolved references). The link editor returns at least a 4 when there are duplicate symbols, and at least an 8 when there are unresolved references and automatic library call was used.

*prefix\_***ASUFFIX** (15)

The suffix by which **c89/cc/c++** recognizes an archive file. This environment variable does not affect the treatment of archive libraries specified as **-l** operands, which are always prefixed with *lib* and suffixed with *.a*. The default value is *a*.

*prefix\_***ASUFFIX\_HOST** (15)

The suffix by which **c89/cc/c++** recognizes a library data set. This environment variable does not affect the treatment of data set libraries specified as **-l** operands, which are always used exactly as specified. The default value is *LIB*.

*prefix\_***CCMODE**

Controls how **c89/cc/c++** does parsing. The default behavior of **c89/cc/c++** is to expect all options to precede all operands. Setting this variable allows compatibility with historical implementations (other **cc** commands). When set to 1, **c89/cc/c++** operates as follows:

- Options and operands can be interspersed.
- The double dash (`—`) is ignored.

Setting this variable to 0 results in the default behavior. The default value is 0.

*prefix\_***CLASSLIB\_PREFIX** (17)

The prefix for the following named data sets used during the compilation phase and execution of your C++ application.

To be used, the following data sets must be cataloged:

- The data sets `${prefix}_CLASSLIB_PREFIX}.SCLBH.+` contain the z/OS XL C++ Class Library include (header) files.
- The data set `${prefix}_CLASSLIB_PREFIX}.SCLBSID` contains the z/OS XL C++ Class Library definition side-decks.

The following data sets are also used:

The data sets  $\${prefix\_CLASSLIB\_PREFIX}.SCLBDLL$  and  $\${prefix\_CLASSLIB\_PREFIX}.SCLBDLL2$  contain the z/OS XL C++ Class Library DLLs and messages.

The preceding data sets contain MVS programs that are invoked during the execution of a C++ application built by **c++**. To be executed correctly, these data sets must be made part of the MVS search order. Regardless of the setting of this or any other **c++** environment variable, **c++** does not affect the MVS search order. These data sets are listed here for information only, to assist in identifying the correct data sets to be added to the MVS program search order.

The default value is the value of the environment variable: `_CXX_CLIB_PREFIX`. The `prefix_CLASSLIB_PREFIX` environment variable applies only to **c++** and **cxx** command names. `_CXX` is the only valid prefix.

#### *prefix\_***CLASSVERSION**

The version of the C++ Class Library to be invoked by **c++**. The setting of this variable allows **c++** to control which C++ Class Library named data sets are used during the **c++** processing phases. It also sets default values for other environment variables.

The format of this variable is the same as the result of the Language Environment C/C++ run-time library function `_librel()`. See *z/OS XL C/C++ Run-Time Library Reference* for a description of the `_librel()` function. The default value is the same as the value for the `_CVERSION` environment variable. If `_CVERSION` is not set, then the default value will be the result of the C/C++ Run-Time library `_librel()` function.

The `prefix_CLASSVERSION` environment variable applies only to the **c++** and **cxx** command names. `_CXX` is the only valid prefix.

#### *prefix\_***CLIB\_PREFIX** (17)

The prefix for the following named data set used during the compilation phase.

The data set  $\${prefix\_CLIB\_PREFIX}.SCCNCMP$  contains the compiler programs called by **c89/cc/c++**.

The preceding data set contains MVS programs that are invoked during the execution of **c89/cc/c++** and during the execution of a C/C++ application built by **c89/cc/c++**. To be executed correctly, the data set must be made part of the MVS search order. Regardless of the setting of this or any other **c89/cc/c++** environment variable, **c89/cc/c++** does not affect the MVS search order. The data set is listed here for information only, to assist in identifying the correct data set to be added to the MVS program search order.

The following data set is also used:

The data set  $\${prefix\_CLIB\_PREFIX}.SCCNOBJ$  contains object files required to instrument the code for profile-driven feedback optimization.

The default value is `CBC`.

#### *prefix\_***CMEMORY**

A suggestion as to the use of compiler C/C++ Runtime Library memory files. When set to 0, **c89/cc/c++** will prefer to use the compiler `NOMEMORY` option. When set to 1, **c89/cc/c++** will prefer to use the compiler `MEMORY` option. When set to 1, and if the compiler `MEMORY` option can be used, **c89/cc/c++** need not allocate data sets for the



corresponding work files. In this case it is the responsibility of the user to not override the compiler options (using the `-W` option) with the `NOMEMORY` option or any other compiler option which implies the `NOMEMORY` option.

The default value is 1.

*prefix\_***CMSG**S (14)

The Language Environment national language name used by the compiler program. A null value will cause the default Language Environment NATLANG run-time name to be used, and a non-null value must be a valid Language Environment NATLANG run-time option name (Language Environment run-time options are described in *z/OS Language Environment Programming Guide* . The default value is "" (null).

*prefix\_***CNAME** (14)

The name of the compiler program called by **c89/cc/c++**. It must be a member of a data set in the search order used for MVS programs. The default value is CCNDRVR. If **c89/cc/c++** is being used with *prefix\_CVERSION* set to a release prior to z/OS V1R2, the default value will be CBCDRVR.

*prefix\_***CSUFFIX** (15)

The suffix by which **c89/cc/c++** recognizes a C source file. The default value is c.

*prefix\_***CSUFFIX\_HOST** (15)

The suffix by which **c89/cc/c++** recognizes a C source data set. The default value is C.

*prefix\_***CSYSLIB** (4, 16)

The system library data set concatenation to be used to resolve `#include` directives during compilation.

Normally `#include` directives are resolved using all the information specified including the directory name. When **c89/cc/c++** can determine that the directory information can be used, such as when the include (header) files provided by Language Environment are installed in the default location (in accordance with *prefix\_INCDIRS*), then the default concatenation is "" (null).

When **c89/cc/c++** cannot determine that the directory information can be used, then the default concatenation is:

```
"${prefix_PLIB_PREFIX}.SCEEH.H"
"${prefix_PLIB_PREFIX}.SCEEH.SYS.H"
"${prefix_PLIB_PREFIX}.SCEEH.ARPA.H"
"${prefix_PLIB_PREFIX}.SCEEH.NET.H"
"${prefix_PLIB_PREFIX}.SCEEH.NETINET.H"
```

When this variable is a null value, then no allocation is done for compiler system library data sets. In this case, the use of `//DD:SYSLIB` on the `-I` option and the `#include` directive will be unsuccessful. Unless there is a dependency on the use of `//DD:SYSLIB`, it is recommended that for improved performance this variable be allowed to default to a null value.

*prefix\_***CVERSION**

The version of the z/OS XL C/C++ compiler to be invoked by **c89/cc/c++**. The setting of this variable allows **c89/cc/c++** to control which z/OS XL C/C++ compiler program is invoked. It also sets default values for other environment variables.

The format of this variable is the same as the result of the Language Environment C/C++ run-time library function `_librel()`. See *z/OS XL C/C++ Run-Time Library Reference* for a description of the `_librel()` function. The default value is the result of the C/C++ Run-Time library `_librel()` function.

In order for **c89/cc/c++** to use the OS/390 V2R10 C/C++ compiler and C++ Class Library, this variable should be set to the value `0x220A0000`.

*prefix\_***CXXSUFFIX** (15)

The suffix by which **c++** recognizes a C++ source file. The default value is C. This environment variable is only supported by the **c++** and **cxx** command names. `_CXX` is the only valid prefix.

*prefix\_***CXXSUFFIX\_HOST** (15)

The suffix by which **c++** recognizes a C++ source data set. The default value is CXX. This environment variable is only supported by the **c++** and **cxx** command names. `_CXX` is the only valid prefix.

*prefix\_***DAMPLEVEL**

The minimum severity level of dynamic allocation messages returned by dynamic allocation message processing. Messages with severity greater than or equal to this number are written to `stderr`. However, if the number is out of the range shown here (that is, less than 0 or greater than 8), then **c89/cc/c++** dynamic allocation message processing is disabled. The default value is 4. Following are the values:

|     |               |
|-----|---------------|
| 0   | Informational |
| 1–4 | Warning       |
| 5–8 | Severe        |

*prefix\_***DAMPNAME** (14)

The name of the dynamic allocation message processing program called by **c89/cc/c++**. It must be a member of a data set in the search order used for MVS programs. The default dynamic allocation message processing program is described in *z/OS MVS Programming: Authorized Assembler Services Guide*. The default value is `IEFDB476`.

*prefix\_***DCBF2008** (21)

The DCB parameters used by **c89/cc/c++** for data sets with the attributes of record format fixed unblocked and minimum block size of 2008. The block size must be in multiples of 8, and the maximum depends on the phase in which it is used but can be at least 5100. The default value is `(RECFM=F,LRECL=4088,BLKSIZE=4088)`.

*prefix\_***DCBU** (21)

The DCB parameters used by **c89/cc/c++** for data sets with the attributes of record format undefined and data set organization partitioned. This DCB is used by **c89/cc/c++** for the output file when it is to be written to a data set. The default value is `(RECFM=U,LRECL=0,BLKSIZE=6144,DSORG=PO)`.

*prefix\_***DCB121M** (21)

The DCB parameters used by **c89/cc/c++** for data sets with the attributes of record format fixed blocked and logical record length 121, for data sets whose records may contain machine control characters. The default value is `(RECFM=FBM,LRECL=121,BLKSIZE=3630)`.

*prefix\_***DCB133M** (21)

The DCB parameters used by **c89/cc/c++** for data sets with the attributes of record format fixed blocked and logical record length 133, for data sets



whose records may contain machine control characters. The default value is (RECFM=FBM,LRECL=133,BLKSIZE=3990).

*prefix\_***DCB137** (21)

The DCB parameters used by **c89/cc/c++** for data sets with the attributes of record format variable blocked and logical record length 137. The default value is (RECFM=VB,LRECL=137,BLKSIZE=882).

*prefix\_***DCB137A** (21)

The DCB parameters used by **c89/cc/c++** for data sets with the attributes of record format variable blocked and logical record length 137, for data sets whose records may contain ISO/ANSI control characters. The default value is (RECFM=VB,LRECL=137,BLKSIZE=882).

*prefix\_***DCB3200** (21)

The DCB parameters used by **c89/cc/c++** for data sets with the attributes of record format fixed blocked and logical record length 3200. The default value is (RECFM=FB,LRECL=3200,BLKSIZE=12800).

*prefix\_***DCB80** (21)

The DCB parameters used by **c89/cc/c++** for data sets with the attributes of record format fixed blocked and logical record length 80. This value is also used when **c89/cc/c++** allocates a new data set for an object file. The default value is (RECFM=FB,LRECL=80,BLKSIZE=3200).

*prefix\_***DEBUG\_FORMAT** (21)

This variable is used to determine to which debug format (DWARF or ISD) the **-g** flag is translated. If **\_DEBUG\_FORMAT** is set to DWARF, then **-g** is translated to **DEBUG(FORMAT(DWARF))**. If **\_DEBUG\_FORMAT** is set to ISD, then **-g** is translated to **TEST**. The default value is DWARF.

**Note:** This environment variable only applies to 31-bit compiles.

*prefix\_***ELINES**

This variable controls whether the output of the **-E** option will include **#line** directives. **#line** directives provide information about the source file names and line numbers from which the preprocessed source came. The preprocessor only inserts **#line** directives where it is necessary. When set to 1, the output of the **c89/cc/c++ -E** option will include **#line** directives where necessary. When set to 0, the output will not include any **#line** directives. The default value is 0.

*prefix\_***EXTRA\_ARGS**

The setting of this variable controls whether **c89/cc/c++** treats a file operand with an unrecognized suffix as an error, or attempts to process it. When the **c++** command **-+** option is specified, all suffixes which otherwise would be unrecognized are instead recognized as C++ source, effectively disabling this environment variable. See page 491 for information about the **-+** option.

When set to 0, **c89/cc/c++** treats such a file as an error and the command will be unsuccessful, because the suffix will not be recognized.

When set to 1, **c89/cc/c++** treats such a file as either an object file or a library, depending on the file itself. If it is neither an object file nor a library then the command will be unsuccessful, because the link-editing phase will be unable to process it. The default value for **c89** and **c++** is 0. The default value for **cc** is 1.

*prefix\_***IL6SYSIX** (7, 16)

The system definition side-deck list that is used to resolve symbols during

the IPA Link step of the link-editing phase when using LP64 (see the description of LP64 in “Options” on page 491). The default value is whatever *prefix\_L6SYSIX* is set to or defaults to.

*prefix\_IL6SYSLIB* (7, 16)

The system library data set list that is used to resolve symbols during the IPA Link step of the link-editing phase when using LP64 (see the description of LP64 in “Options” on page 491). The default value is whatever *prefix\_L6SYSLIB* is set to or defaults to.

*prefix\_ILCTL* (14)

The name of the control file used by the IPA linker program. By default the control file is not used, so the `-W` option must be specified to enable its use, as in:

```
c89 -WI,control ...
```

The default value is `ipa.ct1`.

*prefix\_ILMSGs* (14)

The name of the message data set member, or the Language Environment national language name, used by the IPA linker program. The default value is whatever *prefix\_CMSGs* is. So if *prefix\_CMSGs* is set or defaults to "" (null), the default value is "" (null).

*prefix\_ILNAME* (14)

The name of the IPA linker program called by **c89/cc**. It must be a member of a data set in the search order used for MVS programs. The default value is whatever *prefix\_CNAME* is. So if *prefix\_CNAME* is set or defaults to CCNDRVR the default value is CCNDRVR.

*prefix\_ILSUFFIX* (15)

The suffix **c89/cc** uses when creating an IPA linker output file. The default value is `I`.

*prefix\_ILSUFFIX\_HOST* (15)

The suffix **c89/cc** uses when creating an IPA linker output data set. The default value is `IPA`.

*prefix\_ILSYSLIB* (7, 16)

The system library data set list to be used to resolve symbols during the IPA Link step of the link-editing phase of non-XPLINK programs. The default value is whatever *prefix\_PSYSLIB* is set or defaults to, followed by whatever *prefix\_LSYSLIB* is set or defaults to.

*prefix\_ILSYSIX* (7, 16)

The system definition side-deck list to be used to resolve symbols during the IPA Link step of the link-editing phase in non-XPLINK programs. The default value is whatever *prefix\_PSYSIX* is set or defaults to.

*prefix\_ILXSYSLIB* (7, 16)

The system library data set list to be used to resolve symbols during the IPA Link step of the link-editing phase when using XPLINK (see XPLINK (Extra Performance Linkage) in “Options” on page 491). The default value is whatever *prefix\_LXSYSLIB* is set or defaults to.

*prefix\_ILXSYSIX* (7, 16)

The system definition side-deck list to be used to resolve symbols during the IPA Link step of the link-editing phase when using XPLINK (see XPLINK (Extra Performance Linkage) in “Options” on page 491). The default value is whatever *prefix\_LXSYSIX* is set or defaults to.

*prefix\_INCDIRS* (22)

The directories used by **c89/cc/c++** as a default place to search for include files during compilation (before searching *prefix\_INCLIBS* and *prefix\_CSYSLIB*). If **c++** is not being used the default value is `/usr/include`. If **c++** is being used the default value is `/usr/include /usr/lpp/cbclib/include`.

*prefix\_INCLIBS* (22)

The directories used by **c89/cc/c++** as a default place to search for include files during compilation (after searching *prefix\_INCDIRS* and before searching *prefix\_CSYSLIB*). The default value depends on whether or not **c++** is being used. If **c++** is not being used the default value is `/${prefix_PLIB_PREFIX}.SCEEH.+'`

If **c++** is being used, the default value is `/${prefix_PLIB_PREFIX}.SCEEH.+' /${prefix_CLIB_PREFIX}.SCLBH.+'`

*prefix\_ISUFFIX* (15)

The suffix by which **c89/cc/c++** recognizes a preprocessed C source file. The default value is `i`.

*prefix\_ISUFFIX\_HOST* (15)

The suffix by which **c89/cc/c++** recognizes a preprocessed (expanded) C source data set. The default value is `CEX`.

*prefix\_IXXSUFFIX* (15)

The suffix by which **c++** recognizes a preprocessed C++ source file. The default value is `i`. This environment variable is only supported by the **c++** and **cxx** command names. `_CXX` is the only valid prefix.

*prefix\_IXXSUFFIX\_HOST* (15)

The suffix by which **c++** recognizes a preprocessed (expanded) C++ source data set. The default value is `CEX`. This environment variable is only supported by the **c++** and **cxx** command names. `_CXX` is the valid prefix.

*prefix\_L6SYSIX* (7, 16)

The system definition side-deck list that resolves symbols during the link-editing phase when using LP64 (see the description of LP64 in "Options" on page 491). A definition side-deck contains link-editing phase `IMPORT` control statements, which name symbols that are exported by a DLL. The default value depends on whether or not **c++** is used. If **c++** is not used, the default value is: `/${prefix_PLIB_PREFIX}.SCEELLIB(CELQS003)`. If **c++** is used, the default value is the list concatenation:

```
"${prefix_PLIB_PREFIX}.SCEELIB(CELQS003,CELQSCPP,C64)"
"${prefix_CLASSLIB_PREFIX}.SCLBSID(IOSX64)"
```

*prefix\_L6SYSLIB* (7, 16)

The system library data set concatenation that is used to resolve symbols during the link-editing step when using LP64 (see the description of LP64 in "Options" on page 491). The default value is the concatenation:

```
"${prefix_PLIB_PREFIX}.SCEEEND2"
"${prefix_SLIB_PREFIX}.CSSLIB"
```

*prefix\_LIBDIRS* (22)

The directories used by **c89/cc/c++** as the default place to search for archive libraries which are specified using the `-I` operand. The default value is `/lib /usr/lib`.

*prefix\_LSYSLIB* (7, 16)

The system library data set concatenation to be used to resolve symbols during the IPA Link step and the link-edit step of the non-XPLINK link-editing phase. The *prefix\_PSYSLIB* libraries always precede the

*prefix\_LSYSLIB* libraries when resolving symbols in the link-editing phase. The default value is the concatenation:

```
"${prefix_PLIB_PREFIX}.SCEELKEX"  
"${prefix_PLIB_PREFIX}.SCEELKED"  
"${prefix_SLIB_PREFIX}.CSSLIB"
```

*prefix\_LXSYSLIB* (7, 16)

The system library data set concatenation to be used to resolve symbols during the IPA Link step and the link-editing phase when using XPLINK (see XPLINK (Extra Performance Linkage) in “Options” on page 491). The default value is the concatenation:

```
"${prefix_PLIB_PREFIX}.SCEEEND2"  
"${prefix_SLIB_PREFIX}.CSSLIB"
```

*prefix\_LXSYSIX* (7, 16)

The system definition side-deck list to be used to resolve symbols during the link-editing phase when using XPLINK (see XPLINK (Extra Performance Linkage) in “Options” on page 491). A definition side-deck contains link-editing phase IMPORT control statements naming symbols which are exported by a DLL. The default value depends on whether or not **c++** is being used. For 32-bit objects, if **c++** is not being used, the default value is the list `${prefix_PLIB_PREFIX}.SCEELIB(CELHS003,CELHS001)`. For 32-bit objects, if **c++** is being used with *prefix\_PVERSION* and *prefix\_CLASSVERSION* defaulted to the current z/OS release, the default value is the list concatenation:

```
"${prefix_PLIB_PREFIX}.SCEELIB(CELHS003,CELHS001,CELHSCPP,C128)"  
"${prefix_CLASSLIB_PREFIX}.SCLBSID(IOSTREAM,COMPLEX)"
```

For 32-bit objects, if **c++** is being used with *prefix\_PVERSION* and *prefix\_CLASSVERSION* set to a release prior to z/OS V1R2 for a 32-bit program, the default value is the list concatenation:

```
"${prefix_PLIB_PREFIX}.SCEELIB(CELHS003,CELHS001,CELHSCPP)"  
"${prefix_CLASSLIB_PREFIX}.SCLBSID(ASCCOLL,COMPLEX,IOSTREAM)"
```

**Note:** For 64-bit objects, see *prefix\_L6SYSIX*.

*prefix\_MEMORY*

A suggestion as to the use of XL C/C++ run-time library memory files by **c89/cc/c++**. When set to 0, **c89/cc/c++** uses temporary data sets for all work files. When set to 1, **c89/cc/c++** uses memory files for all work files that it can. The default value is 1.

*prefix\_NEW\_DATACLAS* (18)

The DATACLAS parameter used by **c89/cc/c++** for any new data sets it creates. The default value is "" (null).

*prefix\_NEW\_DSNTYPE* (18, 20)

The DSNTYPE parameter used by **c89/cc/c++** for any new data sets it creates. The default value is "" (null).

*prefix\_NEW\_MGMTCLAS* (18)

The MGMTCLAS parameter used by **c89/cc/c++** for any new data sets it creates. The default value is "" (null).

*prefix\_NEW\_SPACE* (18, 19)

The SPACE parameters used by **c89/cc/c++** for any new data sets it creates. A value for the number of directory blocks should always be specified. When allocating a sequential data set, **c89/cc/c++** automatically ignores the specification. The default value is (, (10,10,10)).

*prefix\_NEW\_STORCLAS* (18)

The STORCLAS parameter used by **c89/cc/c++** for any new data sets it creates. The default value is "" (null).

*prefix\_NEW\_UNIT* (18)

The UNIT parameter used by **c89/cc/c++** for any new data sets it creates. The default value is "" (null).

*prefix\_NOCMDOPTS* (27)

Controls how the compiler processes the default options set by **c89**. Setting this variable to 1, reverts the compiler to the behavior that was available prior to z/OS V1R5, when the compiler was unable to distinguish between the **c89** defaults and the user-specified options. Setting this variable to 0, results in the default behavior where the compiler is now able to recognize **c89** defaults. The default value is 0.

*prefix\_OPERANDS* (22)

These operands are parsed as if they were specified after all other operands on the **c89/cc/c++** command line. The default value is "" (null).

*prefix\_OPTIONS* (22)

These options are parsed as if they were specified before all other options on the **c89/cc/c++** command line. The default value is "" (null).

*prefix\_OSUFFIX* (15)

The suffix by which **c89/cc/c++** recognizes an object file. The default value is o.

*prefix\_OSUFFIX\_HOST* (15)

The suffix by which **c89/cc/c++** recognizes an object data set. The default value is OBJ.

*prefix\_OSUFFIX\_HOSTQUAL*

The data set name of an object data set is determined by the setting of this option. If it is set to 0, then the suffix *prefix\_OSUFFIX\_HOST* is appended to the source data set name to produce the object data set name. If it is set to 1, then the suffix *prefix\_OSUFFIX\_HOST* replaces the last qualifier of the source data set name to produce the object data set name (unless there is only a single qualifier, in which case the suffix is appended). The default value is 1.

**Note:** Earlier versions of c89 always appended the suffix, which was inconsistent with the treatment of files in the hierarchical file system. It is recommended that any existing data sets be converted to use the new convention.

*prefix\_OSUFFIX\_HOSTRULE*

The way in which suffixes are used for host data sets is determined by the setting of this option. If it is set to 0, then data set types are determined by the rule described in the note which follows. If it is set to 1, then the data set types are determined by last qualifier of the data set (just as a suffix is used to determine the type of hierarchical file system file). Each host file type has an environment variable by which the default suffix can be modified. The default value is 1.

**Notes:**

1. Earlier versions of c89 scanned the data set name to determine if it was an object data set. It searched for the string OBJ in the data set name, exclusive of the first qualifier and the member name. If it was found, the data set was determined to be an object data set, and otherwise it was

determined to be a C source data set. It is recommended that any existing data sets be converted to use the new convention. Also, because the earlier convention only provided for recognition of C source files, assembler source cannot be processed if it is used.

2. The **c++** command does not support this environment variable, as the earlier convention would not provide for recognition of both C++ and C source files. Therefore regardless of its setting, **c++** always behaves as if it is set to 1.

#### *prefix\_***PLIB\_PREFIX** (17)

The prefix for the following named data sets used during the compilation, assemble, and link-editing phases, and during the execution of your application.

To be used, the following data sets must be cataloged:

- The data sets  $\${prefix\_PLIB\_PREFIX}.SCEEH.+$  contain the include (header) files for use with the run-time library functions (where + can be any of H, SYS.H, ARPA.H, NET.H, and NETINET.H).
- The data set  $\${prefix\_PLIB\_PREFIX}.SCEEMAC$  contains COPY and MACRO files to be used during assembly.
- The data sets  $\${prefix\_PLIB\_PREFIX}.SCEEOBJ$  and  $\${prefix\_PLIB\_PREFIX}.SCEECPP$  contain run-time library bindings which exploit constructed reentrancy, used during the link-editing phase of non-XPLINK programs.
- The data set  $\${prefix\_PLIB\_PREFIX}.SCEELKEX$  contains C run-time library bindings which exploit L-names used during the link-editing phase of non-XPLINK programs. For more information about L-names, see usage note 23 on page 524.
- The data set  $\${prefix\_PLIB\_PREFIX}.SCEELKED$  contains all other Language Environment run-time library bindings, used during the link-editing phase of non-XPLINK programs.
- The data set  $\${prefix\_PLIB\_PREFIX}.SCEEBND2$  contains all static Language Environment run-time library bindings, used during the link-editing phase of XPLINK programs.
- The data set  $\${prefix\_PLIB\_PREFIX}.SCEELIB$  contains the definition side-decks for the run-time library bindings, used during the link-editing phase of XPLINK programs.

The following data sets are also used:

- The data sets  $\${prefix\_PLIB\_PREFIX}.SCEERUN$  and  $\${prefix\_PLIB\_PREFIX}.SCEERUN2$  contain the run-time library programs.

The above data sets contain MVS programs that are invoked during the execution of **c89/cc/c++** and during the execution of a C/C++ application built by **c89/cc/c++**. To be executed correctly, these data sets must be made part of the MVS search order. Regardless of the setting of this or any other **c89/cc/c++** environment variable, **c89/cc/c++** does not affect the MVS program search order. These data sets are listed here for information only, to assist in identifying the correct data sets to be added to the MVS program search order. The default value is CEE.

#### *prefix\_***PMEMORY**

A suggestion as to the use of prelinker C/C++ Runtime Library memory



files. When set to 0, **c89/cc/c++** uses the prelinker NOMEMORY option. When set to 1, **c89/cc/c++** uses the prelinker MEMORY option. The default value is 1.

*prefix\_PMSG* (14)

The name of the message data set used by the prelinker program. It must be a member of the cataloged data set `${prefix_PLIB_PREFIX}.SCEEMSGP`. The default value is `EDCPMSG`.

*prefix\_PNAME* (14)

The name of the prelinker program called by **c89/cc/c++**. It must be a member of a data set in the search order used for MVS programs. The prelinker program is shipped as a member of the `${prefix_PLIB_PREFIX}.SCEERUN` data set. The default value is `EDCPRLK`.

*prefix\_PSUFFIX* (15)

The suffix **c89/cc/c++** uses when creating a prelinker (composite object) output file. The default value is `p`.

*prefix\_PSUFFIX\_HOST* (15)

The suffix **c89/cc/c++** uses when creating a prelinker (composite object) output data set. The default value is `CPOBJ`.

*prefix\_PSYSIX* (16)

The system definition side-deck list to be used to resolve symbols during the non-XPLINK link-editing phase. A definition side-deck contains link-editing phase `IMPORT` control statements naming symbols which are exported by a DLL. The default value when **c++** is not being used is null. If **c++** is being used with *prefix\_PVERSION* and *prefix\_CLASSVERSION* set or defaulted to the current z/OS release, the default value is the list concatenation:

```
"${prefix_PLIB_PREFIX}.SCEELIB(C128)"
"${prefix_CLASSLIB_PREFIX}.SCLBSID(IOSTREAM,COMPLEX)"
```

If **c++** is being used with *prefix\_PVERSION* and *prefix\_CLASSVERSION* set to a release prior to z/OS V1R2, the default value is the list `${prefix_CLASSLIB_PREFIX}.SCLBSID(ASCCOLL,COMPLEX,IOSTREAM)`

*prefix\_PSYSLIB* (16)

The system library data set list to be used to resolve symbols during the non-XPLINK link-editing phase. The *prefix\_PSYSLIB* libraries always precede the *prefix\_LSYSLIB* libraries when resolving symbols in the link-editing phase. The default value depends on whether or not **c++** is being used. If **c++** is not being used, the default value is the list containing the single entry:

```
"${prefix_PLIB_PREFIX}.SCEE0BJ"
```

If **c++** is being used, the default value is the list:

```
"${prefix_PLIB_PREFIX}.SCEE0BJ"
"${prefix_PLIB_PREFIX}.SCEE0PP"
```

*prefix\_PVERSION* (26)

The version of the Language Environment to be used with **c89/cc/c++**. The setting of this variable allows **c89/cc/c++** to control which Language Environment named data sets are used during the **c89/cc/c++** processing phases. These named data sets include those required for use of the C/C++ run-time library as well as the ISO C++ Library. It also sets default values for other environment variables.

The format of this variable is the same as the result of the Language Environment C/C++ run-time library function `_librel()`. See *z/OS XL C/C++ Run-Time Library Reference* for a description of the `_librel()` function. The default value is the result of the C/C++ Run-Time library `_librel()` function.

*prefix\_***SLIB\_PREFIX** (17)

The prefix for the named data sets used by the link editor (CSSLIB) and the assembler system library data sets (MACLIB and MODGEN). The data set `_${prefix_}SLIB_PREFIX.CSSLIB` contains the z/OS UNIX assembler callable services bindings. The data sets `_${prefix_}SLIB_PREFIX.MACLIB` and `_${prefix_}SLIB_PREFIX.MODGEN` contain COPY and MACRO files to be used during assembly. These data sets must be cataloged to be used. The default value is SYS1.

*prefix\_***SNAME** (14)

The name of the assembler program called by **c89/cc/c++**. It must be a member of a data set in the search order used for MVS programs. The default value is ASMA90.

*prefix\_***SSUFFIX** (15)

The suffix by which **c89/cc/c++** recognizes an assembler source file. The default value is s.

*prefix\_***SSUFFIX\_HOST** (15)

The suffix by which **c89/cc/c++** recognizes an assembler source data set. The default value is ASM.

*prefix\_***SSYSLIB** (16)

The system library data set concatenation to be used to find COPY and MACRO files during assembly. The default concatenation is:

```
"${prefix_}PLIB_PREFIX.SCEEMAC"  
"${prefix_}SLIB_PREFIX.MACLIB"  
"${prefix_}SLIB_PREFIX.MODGEN"
```

*prefix\_***STEPS**

The steps that are executed for the link-editing phase can be controlled with this variable. For example, the prelinker step can be enabled, so that the inputs normally destined for the link editor instead go into the prelinker, and then the output of the prelinker becomes the input to the link editor.

This variable allows the prelinker to be used in order to produce output which is compatible with previous releases of **c89/cc/c++**. The prelinker is normally used by **c89/cc/c++** when the output file is a data set which is not a PDSE (partitioned data set extended).

**Note:** The prelinker and XPLINK are incompatible. When using the link editor XPLINK option, the prelinker cannot be used. Thus, specifying the prelinker on this variable will have no effect.

The format of this variable is a set of binary switches which either enable (when turned on) or disable (when turned off) the corresponding step. Turning a switch on will not cause a step to be enabled if it was not already determined by **c89/cc/c++** that any other conditions necessary for its use are satisfied. For example, the IPA Link step will not be executed unless the -W option is specified to enable the IPA linker. Enabling the IPA linker is described under the -W option on page 499.



Considering this variable to be a set of 32 switches, numbered left-to-right from 0 to 31, the steps corresponding to each of the switches are as follows:

|             |                 |
|-------------|-----------------|
| <b>0-27</b> | Reserved        |
| <b>28</b>   | TEMPINC/IPATEMP |
| <b>29</b>   | IPALINK         |
| <b>30</b>   | PRELINK         |
| <b>31</b>   | LINKEDIT        |

**Example:** To override the default behavior of **c89/cc/c++** and cause the prelinker step to be run (this is also the default when the output file is a data set which is not a PDSE), set this variable to: 0xffffffff or the equivalent, -1. The default value when the output file is a z/OS UNIX file or a PDSE data set is 0xfffffffD or the equivalent, -3.

**Note:** The IPATEMP step is the IPA equivalent of the TEMPINC (automatic template generation) step, just as the IPACOMP step is the IPA equivalent of the COMPILE step. See the description of IPA under the -W option for more information.

*prefix\_***SUSRLIB** (16)

The user library data set concatenation to be used to find COPY and MACRO files during assembly (before searching *prefix\_SSYSLIB*). The default value is "" (null).

*prefix\_***TMPS**

The use of temporary files by **c89/cc/c++** can be controlled with this variable.

The format of this variable is a set of binary switches which either cause a temporary file to be used (when turned on) or a permanent file to be used (when turned off) in the corresponding step.

The correspondence of these switches to steps is the same as for the variable *prefix\_STEPS*. Only the prelinker and IPA linker output can be captured using this variable.

**Example:** To capture the prelinker output, set this variable to: 0xfffffffD or the equivalent, -3. The default value is 0xfffffffF or the equivalent, -1.

*prefix\_***WORK\_DATACLAS** (18)

The DATACLAS parameter used by **c89/cc/c++** for unnamed temporary (work) data sets. The default value is "" (null).

*prefix\_***WORK\_DSNTYPE** (18, 20)

The DSNTYPE parameter used by **c89/cc/c++** for unnamed temporary (work) data sets. The default value is "" (null).

*prefix\_***WORK\_MGMTCLAS** (18)

The MGMTCLAS parameter used by **c89/cc/c++** for unnamed temporary (work) data sets. The default value is "" (null).

*prefix\_***WORK\_SPACE** (18, 19)

The SPACE parameters used by **c89/cc/c++** for unnamed temporary (work) data sets. The default value is (32000,(30,30)).

*prefix\_***WORK\_STORCLAS** (18)

The STORCLAS parameter used by **c89/cc/c++** for unnamed temporary (work) data sets. The default value is "" (null).

**prefix\_WORK\_UNIT** (18)

The UNIT parameter used by **c89/cc/c++** for unnamed temporary (work) data sets. The default value is SYSDA.

**prefix\_XSUFFIX** (15)

The suffix by which **c89/cc/c++** recognizes a definition side-deck file of exported symbols. The default value is x.

**prefix\_XSUFFIX\_HOST** (15)

The suffix by which **c89/cc/c++** recognizes a definition side-deck data set of exported symbols. The default value is EXP.

## Files

**libc.a** z/OS XL C/C++ run-time library function library (see Usage Note 7 on page 520).

**libm.a** C/C++ Runtime Library math function library (see Usage Note 7 on page 520)

**libl.a** lex function library

**liby.a** yacc function library

**/dev/fd0, /dev/fd1, ...**

Character special files required by **c89/cc/c++**. For installation information, see *z/OS UNIX System Services Planning*.

**/usr/include**

The usual place to search for include files (see Usage Note 4 on page 519).

**/lib** The usual place to search for run-time library bindings (see Usage Note 7 on page 520).

**/usr/lib**

The usual place to search for run-time library bindings (see Usage Note 7 on page 520).

## Usage notes

1. To be able to specify an operand that begins with a dash (-), before specifying any other operands that do not, you must use the double dash (--) end-of-options delimiter. This also applies to the specification of the -1 operand. (See the description of environment variable *prefix\_CCMODE* for an alternate style of argument parsing.)
2. When invoking **c89/cc/c++** from the shell, any option-arguments or operands specified that contain characters with special meaning to the shell must be escaped. For example, some -W option-arguments contain parentheses. Source files specified as PDS member names contain parentheses; if they are specified as fully qualified names, they contain single quotes.  
To escape these special characters, either enclose the option-argument or operand in double quotes, or precede each character with a backslash.
3. Some **c89/cc/c++** behavior applies only to hierarchical files (and not to data sets).
  - If the compile or assemble is not successful, the corresponding object file (*file.o*) is always removed.
  - If the DLL option is passed to the link-editing phase, and afterwards the *file.x* file exists but has a size of zero, then that file is removed.

4. MVS data sets may be used as the usual place to resolve C and C++ #include directives during compilation.

Such data sets are installed with Language Environment. When it is allocated, searching for these include files can be specified on the -I option as //DD:SYSLIB. (See the description of environment variable *prefix\_CSYSLIB* for information.)

When include files are MVS PDS members, z/OS XL C/C++ uses conversion rules to transform the include (header) file name on a #include preprocessor directive into a member name. If the "//dataset\_prefix.+" syntax is not used for the MVS data set which is being searched for the include file, then this transformation strips any directory name on the #include directive, and then takes the first 8 or fewer characters up to the first dot (.).

If the "//dataset\_prefix.+" syntax is used for the MVS data set which is being searched for the include file, then this transformation uses any directory name on the #include directive, and the characters following the first dot (.), and substitutes the "+" of the data set being searched with these qualifiers.

In both cases the data set name and member name are converted to uppercase and underscores (\_) are changed to at signs (@).

If the include (header) files provided by Language Environment are installed into the hierarchical file system in the default location (in accordance with the *prefix\_INCDIRS* environment variable), then the compiler will use those files to resolve #include directives during compilation. **c89/cc/c++** by default searches the directory /usr/include as the usual place, just before searching the data sets just described. See the description of environment variables *prefix\_CSYSLIB*, *prefix\_INCDIRS*, and *prefix\_INCLIBS* for information on customizing the default directories to search.

5. Feature test macros control which symbols are made visible in a source file (typically a header file). **c89/cc/c++** automatically defines the following feature test macros along with the errno macro, according to whether or not **cc** was invoked.

- Other than **cc**
  - D "errno>(\*\_\_errno())"
  - D \_OPEN\_DEFAULT=1
- **cc**
  - D "errno>(\*\_\_errno())"
  - D \_OPEN\_DEFAULT=0
  - D \_NO\_PROTO=1

**c89/cc/c++** add these macro definitions only after processing the command string. Therefore, you can override these macros by specifying -D or -U options for them on the command string.

6. The default LANGLVL and related compiler options are set according to whether **cc**, **c89**, or **c++ (cxx)** was invoked. These options affect various aspects of the compilation, such as z/OS XL C/C++ predefined macros, which are used like feature test macros to control which symbols are made visible in a source file (typically a header file), but are normally not defined or undefined except by this compiler option. They can also affect the language rules used by the compiler. For more information about z/OS XL C/C++ predefined macros, see *z/OS XL C/C++ Language Reference*. The options are shown here in a syntax that the user can specify on the **c89/cc/c++** command line to override them:

- **c89** (also **c++ (cxx)**) when using a C++ compiler older than z/OS v1r2
  - W "c,langlvl(ansi),noupconv"
- **c++ (cxx)**

-W "c,langlvl(extended,nolibext,nolonglong)

- **cc**

-W "c,langlvl(commonc),upconv"

7. By default the usual place for the -L option search is the /lib directory followed by the /usr/lib directory. See the description of environment variable *prefix\_LIBDIRS* for information on customizing the default directories to search. The archive libraries libc.a and libm.a exist as files in the usual place for consistency with other implementations. However, the run-time library bindings are not contained in them. Instead, MVS data sets installed with the Language Environment run-time library are used as the usual place to resolve run-time library bindings. In the final step of the link-editing phase, any MVS load libraries specified on the -I operand are searched in the order specified, followed by searching these data sets. See the *prefix\_PLIB\_PREFIX* description, as well as descriptions of the environment variables featured in the following list.

*prefix\_ILSYSLIB*  
*prefix\_ILSYSIX*  
*prefix\_LSYSLIB*  
*prefix\_PSYSIX*  
*prefix\_PSYSLIB*

This list of environment variables affects the link-editing phase of c89, but only for non-XPLINK link-editing. See XPLINK (Extra Performance Linkage) in “Options” on page 491.

The following list of environment variables affects the link-editing phase of c89, but only for ILP32 XPLINK link-editing. See XPLINK (Extra Performance Linkage) in “Options” on page 491.

*prefix\_ILXSYSLIB*  
*prefix\_ILXSYSIX*  
*prefix\_LXSYSLIB*  
*prefix\_LXSYSIX*

The following list of environment variables affects the link-editing phase of c89, but only for LP64 link-editing. See the description of LP64 in “Options” on page 491.

*prefix\_IL6SYSLIB*  
*prefix\_IL6SYSIX*  
*prefix\_L6SYSLIB*  
*prefix\_L6SYSIX*

8. Because archive library files are searched when their names are encountered, the placement of -I operands and *file.a* operands is significant. You may have to specify a library multiple times on the command string, if subsequent specification of *file.o* files requires that additional symbols be resolved from that library.
9. When the prelinker is used during the link-editing phase, you cannot use as input to **c89/cc/c++** an executable file produced as output from a previous use of **c89/cc/c++**. The output of **c89/cc/c++** when the -r option is specified (which is not an executable file) may be used as input.
10. All MVS data sets used by **c89/cc/c++** must be cataloged (including the system data sets installed with the z/OS XL C/C++ compiler and the Language Environment run-time library).
11. **c89/cc/c++** operation depends on the correct setting of their installation and configuration environment variables (see “Environment variables” on page 504). Also, they require that certain character special files are in the /dev directory. For additional installation and configuration information, see *z/OS UNIX System Services Planning*.

12. Normally, options and operands are processed in the order read (from left to right). Where there are conflicts, the last specification is used (such as with **-g** and **-s**). However, some **c89/cc/c++** options will override others, regardless of the order in which they are specified. The option priorities, in order of highest to lowest, are as follows:
- v** specified twice  
The pseudo-JCL is printed only, but the effect of all the other options and operands as specified is reflected in the pseudo-JCL.
  - E** Overrides **-0**, **-O**, **-1**, **-2**, **-3**, **-V**, **-c**, **-g** and **-s** (also ignores any *file.s* files).
  - g** Overrides **-0**, **-O**, **-1**, **-2**, **-3**, and **-s**.
  - s** Overrides **-g** (the last one specified is honored).
  - 0 (zero), -O (capital letter O), -1, -2, -3, -V, -c**  
All are honored if not overridden. **-0**, **-O**, **-1**, **-2**, **-3** override each other (the last one specified is honored).
- Note:** The preferred way for specifying optimization options, is **-O** (capital letter O) followed by a number; for example, **-O2**.
13. For options that have option-arguments, the meaning of multiple specifications of the options is as follows:
- D** All specifications are used. If the same name is specified on more than one **-D** option, only the first definition is used.
  - e** The entry function used will be the one specified on the last **-e** option.
  - I** All specifications are used. If the same directory is specified on more than one **-I** option, the directory is searched only the first time.
  - L** All specifications are used. If the same directory is specified on more than one **-L** option, the directory is searched only the first time.
  - o** The output file used will be the one specified on the last **-o** option.
  - U** All specifications are used. The name is *not* defined, regardless of the position of this option relative to any **-D** option specifying the same name.
  - u** All specifications are used. If a definition cannot be found for any of the functions specified, the link-editing phase will be unsuccessful.
  - W** All specifications are used. All options specified for a phase are passed to it, as if they were concatenated together in the order specified.
14. The following environment variables can be at most eight characters in length. For those whose values specify the names of MVS programs to be executed, you can dynamically alter the search order used to find those programs by using the STEPLIB environment variable.
- c89/cc/c++** environment variables do not affect the MVS program search order. Also, for **c89/cc/c++** to work correctly, the setting of the STEPLIB environment variable should reflect the Language Environment library in use at the time that **c89/cc/c++** is invoked.
- For more information on the STEPLIB environment variable, see *z/OS UNIX System Services Planning*. It is also described under the **sh** command. Note that the STEPLIB allocation in the pseudo-JCL produced by the **-v** verbose

option is shown as a comment, and has no effect on the MVS program search order. Its appearance in the pseudo-JCL is strictly informational.

*prefix\_CMSGS*  
*prefix\_CNAME*  
*prefix\_DAMPNAME*  
*prefix\_ILCTL*  
*prefix\_ILNAME*  
*prefix\_ILMSGS*  
*prefix\_PMSGS*  
*prefix\_PNAME*  
*prefix\_SNAME*

15. The following environment variables can be at most 15 characters in length. You should not specify any dots (.) when setting these environment variables since they would then never match their corresponding operands:

*prefix\_ASUFFIX*  
*prefix\_ASUFFIX\_HOST*  
*prefix\_CSUFFIX*  
*prefix\_CSUFFIX\_HOST*  
*prefix\_CXXSUFFIX*  
*prefix\_CXXSUFFIX\_HOST*  
*prefix\_ISUFFIX*  
*prefix\_ISUFFIX\_HOST*  
*prefix\_ILSUFFIX*  
*prefix\_ILSUFFIX\_HOST*  
*prefix\_IXXSUFFIX*  
*prefix\_IXXSUFFIX\_HOST*  
*prefix\_OSUFFIX*  
*prefix\_OSUFFIX\_HOST*  
*prefix\_PSUFFIX*  
*prefix\_PSUFFIX\_HOST*  
*prefix\_SSUFFIX*  
*prefix\_SSUFFIX\_HOST*  
*prefix\_XSUFFIX*  
*prefix\_XSUFFIX\_HOST*

16. The following environment variables are parsed as colon-delimited data set names, and represent a data set concatenation or a data set list. The maximum length of each specification is 1024 characters:

*prefix\_CSYSLIB*  
*prefix\_IL6SYSIX*  
*prefix\_IL6SYSLIB*  
*prefix\_ILSYSIX*  
*prefix\_ILSYSLIB*  
*prefix\_ILXSYSIX*  
*prefix\_ILXSYSLIB*  
*prefix\_L6SYSIX*  
*prefix\_L6SYSLIB*  
*prefix\_LSYSLIB*  
*prefix\_LXSYSIX*  
*prefix\_LXSYSLIB*  
*prefix\_PSYSIX*  
*prefix\_PSYSLIB*  
*prefix\_SSYSLIB*  
*prefix\_SUSRLIB*

17. The following environment variables can be at most 44 characters in length:

*prefix\_CLASSLIB\_PREFIX*

*prefix\_CLIB\_PREFIX*  
*prefix\_PLIB\_PREFIX*  
*prefix\_SLIB\_PREFIX*

18. The following environment variables can be at most 63 characters in length:

*prefix\_NEW\_DATACLAS*  
*prefix\_NEW\_DSNTYPE*  
*prefix\_NEW\_MGMTCLAS*  
*prefix\_NEW\_SPACE*  
*prefix\_NEW\_STORCLAS*  
*prefix\_NEW\_UNIT*  
*prefix\_WORK\_DATACLAS*  
*prefix\_WORK\_DSNTYPE*  
*prefix\_WORK\_MGMTCLAS*  
*prefix\_WORK\_SPACE*  
*prefix\_WORK\_STORCLAS*  
*prefix\_WORK\_UNIT*

19. The following environment variables are for specification of the SPACE parameter, and support only the syntax as shown with their default values (including all commas and parentheses). Also as shown with their default values, individual subparameters can be omitted, in which case the system defaults are used.

*prefix\_NEW\_SPACE*  
*prefix\_WORK\_SPACE*

20. The following environment variables are for specification of the DSNTYPE parameter, and support only the subparameters LIBRARY or PDS (or null for no DSNTYPE):

*prefix\_NEW\_DSNTYPE*  
*prefix\_WORK\_DSNTYPE*

21. The following environment variables can be at most 127 characters in length:

*prefix\_DCBF2008*  
*prefix\_DCBU*  
*prefix\_DCB121M*  
*prefix\_DCB133M*  
*prefix\_DCB137*  
*prefix\_DCB137A*  
*prefix\_DCB3200*  
*prefix\_DCB80*  
*prefix\_DEBUG\_FORMAT*

These environment variables are for specification of DCB information, and support only the following DCB subparameters, with the noted restrictions:

**RECFM**

Incorrect values are ignored.

**LRECL**

None

**BLKSIZE**

None

**DSORG**

Incorrect values are treated as if no value had been specified.

22. The following environment variables are parsed as blank-delimited words, and therefore no embedded blanks or other white-space is allowed in the value specified. The maximum length of each word is 1024 characters:

*prefix\_INCDIRS*  
*prefix\_INCLIBS*  
*prefix\_LIBDIRS*



*prefix\_OPTIONS*  
*prefix\_OPERANDS*

23. An S-name is a *short* external symbol name, such as produced by the z/OS XL C/C++ compiler when compiling z/OS XL C programs with the NOLONGNAME option. An L-name is a *long* external symbol name, such as produced by the z/OS XL C/C++ compiler when compiling z/OS C programs with the LONGNAME option.
24. The z/OS XL C/C++ run-time library supports a file naming convention of // (the filename can begin with exactly two slashes). *c89/cc/c++* indicate that the file naming convention of // can be used.  
  
However, the Shell and Utilities feature *does not* support this convention. Do not use this convention (//) unless it is specifically indicated (as here in **c89/cc/c++**). The z/OS Shell and Utilities feature does support the POSIX file naming convention where the filename can be selected from the set of character values excluding the slash and the null character.
25. When coding in C and C++, **c89**, **cc**, and **c++**, by default, produce reentrant executables. For more information on reentrancy, see *z/OS XL C/C++ Programming Guide*. When coding in assembler language, the code must not violate reentrancy. If it does, the resulting executable may not be reentrant.
26. The *prefix\_CVERSION*, *prefix\_PVERSION* and *prefix\_CLASSVERSION* environment variables are set to a hex string in the format 0xPVVRRMMM where P is product, VV is version, RR is release and MMM is modification level. For example, the *prefix\_CVERSION* and *prefix\_CLASSVERSION* for the z/OS V1R2 compiler is 0x41020000.
27. *c89* passes some options to the compiler to ensure that expected behavior is achieved; for example, POSIX behavior. These options are passed onto the compiler as defaults that the user can overwrite. When default options passed by *c89* are in conflict with options and/or pragmas that the user specified, the compiler issues warning and/or severe error messages. Since the user did not specify options that *c89* passed as defaults, these messages may confuse the user. Prior to the z/OS V1R5 release, the compiler was unable to differentiate between the options that *c89* passed as defaults and the user-specified options so it was unable to correctly resolve conflicting pragma/option combinations. In some cases, the compiler would overwrite pragmas with the options that *c89* passed as defaults thus limiting a user's ability to use pragmas. As of z/OS V1R5, the compiler is now able to recognize *c89* defaults and avoid confusion from messages for options, which were not explicitly specified by the user, and overriding pragmas, when the user did not explicitly request it. It is believed that most users will benefit from this feature so it is the default behavior. To enable the old behavior, environment variable *prefix\_NOCMDOPTS* must have a non-zero value. **Example:** The following sequence will preserve the old behavior:

```
export _C89_NOCMDOPTS=1
c89 -o hello hello.c
```

---

## Localization

**c89/cc/c++** use the following localization environment variables:

- LANG
- LC\_ALL
- LC\_CTYPE
- LC\_MESSAGES



---

## Exit values

- 0 Successful completion.
- 1 Failure due to incorrect specification of the arguments.
- 2 Failure processing archive libraries:
  - Archive library was not in any of the library directories specified.
  - Archive library was incorrectly specified, or was not specified, following the **-l** operand.
- 3 Step of compilation, assemble, or link-editing phase was unsuccessful.
- 4 Dynamic allocation error, when preparing to call the compiler, assembler, IPA linker, prelinker, or link editor, for one of the following reasons:
  - The file or data set name specified is incorrect.
  - The file or data set name cannot be opened.
- 5 Dynamic allocation error, when preparing to call the compiler, assembler, prelinker, IPA linker, or link editor, due to an error being detected in the allocation information.
- 6 Error copying the file between a temporary data set and a hierarchical file system file (applies to the **-2** option, when processing assembler source files, and **-r** option processing).
- 7 Error creating a temporary control input data set for the link-editing phase.
- 8 Error creating a temporary system input data set for the compile or link-editing phase.

---

## Portability

For **c89**, X/Open Portability Guide, POSIX.2 C-Language Development Utilities Option.

For **cc**, POSIX.2 C-Language Development Utilities Option, UNIX systems.

The following are extensions to the POSIX standard:

- The **-v**, **-V**, **-0**, **-1**, **-2** and **-3** options
- DLL support
- IPA optimization support
- The behavior of the **-o** option in combination with the **-c** option and a single source file.

**Note:** **-Ox** (where **x** is 0, 1, 2, or 3) is equivalent to **-x** because **-x** overrides **-O**. This happens to match the standard compliant syntax of optimization level **x** (**-Ox**), but **Ox** is not treated as a single entity. It may appear redundant to use **-Ox** but it is recommended because it improves portability. In order to avoid creating non-portable legacy, the xlc utility does not support **-x** extension syntax. For example, the following are equivalent but the first syntax is recommended:

```
c89 -02 hello.c
c89 -2 hello.c
```

Features have been added to z/OS releases, which have made it easier to port applications from other platforms to z/OS and improve performance. For compatibility reasons, these portability and performance enhancements could not be

## c89, cc, and c++

made the default. If you are porting an application from another platform to z/OS, you may want to start by specifying the following options:

```
c89 -o HelloWorld -2 -Wc,NOANSIALIAS -Wc,XPLINK\  
-Wl,XPLINK -Wc,'FLOAT(IEEE)' -Wc,'GONUM' HelloWorld.c
```

**Note:** The above string is one line (had to be split to fit page). A space exists between `-Wc,XPLINK` and `-Wl,XPLINK`.

---

## Related information

See the information on the following utilities in *z/OS UNIX System Services Command Reference*: `ar`, `dbx`, `file`, `lex`, `makedepend`, `nm`, `strings`, `strip`, and `yacc`.

---

## Chapter 21. xlc — Compiler invocation using a customizable configuration file

---

### Format

|       |         |          |
|-------|---------|----------|
| xlc   | xlc_x   | xlc_64   |
| xlC   | xlC_x   | xlC_64   |
| xlc++ | xlc++_x | xlc++_64 |
| cc    | cc_x    | cc_64    |
| c89   | c89_x   | c89_64   |
| c99   | c99_x   | c99_64   |
| cxx   | cxx_x   | cxx_64   |
| c++   | c++_x   | c++_64   |

---

### Description

xlc is a utility that uses an external configuration file to control the invocation of the compiler. **xlc** and related commands compile C and C++ source files. They also process assembler source files and object files.

**Note:** Unless the **-c** option is specified, xlc calls the binder to produce an executable module.

All commands accept the following input files with their default z/OS UNIX file system and host suffixes:

- filename with .C suffix (C++ source file)
- filename with .c suffix (C source file)
- filename with .i suffix (preprocessed C or C++ source file)
- filename with .o suffix (object file for binder/IPA Link)
- filename with .s suffix (assembler source file)
- filename with .a suffix (archive library)
- filename with .p suffix (prelinker output file for the binder/IPA Link)
- filename with .l suffix (IPA Link output file for the binder)
- filename with .x suffix (definition side-file or side deck)
- filename with .CXX suffix (C++ source host file)
- filename with .C suffix (C source host file)
- filename with .CEX suffix (preprocessed C or C++ source host file)
- filename with .OBJ suffix (object host file for the binder/IPA Link)
- filename with .ASM suffix (assembler source host file)
- filename with .LIB suffix (host archive library)
- filename with .CPOBJ suffix (prelinker output host file for the binder/IPA Link)
- filename with .IPA suffix (IPA Link output host file for the binder)
- filename with .EXP suffix (host definition side-file or side deck)

The xlc utility invokes the assembler, the z/OS XL C/C++ compiler, and the binder. Invocation of the compiler and the binder is described in “Invoking the compiler” on page 538 and “Invoking the binder” on page 538.

---

## Invocation commands

The xlc utility provides two basic compiler invocation commands, **xlc** and **xIC** (**xlc++**), along with several other compiler invocation commands to support various C/C++ language levels and compilation environments. In most cases, you would use the **xlc** command to compile C source files and **xIC** (**xlc++**) command to compile C++ source files.

You can however, use other forms of the command if your particular environment requires it. The various compiler invocation commands for C are:

- **xlc**
- **cc**
- **c89**
- **c99**
- **xlc\_x**
- **cc\_x**
- **c89\_x**
- **c99\_x**
- **xlc\_64**
- **cc\_64**
- **c89\_64**
- **c99\_64**

The various compiler invocation commands for C++ are:

- **xIC** (**xlc++**)
- **cxx**
- **c++**
- **xIC\_x** (**xlc++\_x**)
- **c++\_x**
- **cxx\_x**
- **xIC\_64** (**xlc++\_64**)
- **c++\_64**
- **cxx\_64**

The two basic compiler invocation commands appear as the first entry of each list item shown above. Select an invocation command using the following criteria:

**xlc** Invokes the compiler for C source files with a default language level of ANSI, the compiler option **-qansialias** to allow type-based aliasing, and the compiler option **-qcpluscmt** to allow C++ style comments (`//`).

### **xIC** (**xlc++**)

Invokes the compiler so that source files are compiled as C++ language source code.

Files with `.c` suffixes, assuming you have not used the `-+` compiler option, are compiled as C language source code with a default language level of ANSI, and compiler option **-qansialias** to allow type-based aliasing.

If any of your source files are C++, you must use this invocation to link with the correct run-time libraries.

**cc** Invokes the compiler for C source files with a default language level of

extended and compiler options **-qnor** and **-qnorconst** (to provide placement of string literals or constant values in read/write storage).

Use this invocation for legacy C code that does not require compliance with ANSI C. This invocation is intended to provide the same compiler behavior as when invoked by the **cc** command name of the c89 utility.

**c89** Invokes the compiler for C source files, with a default language level of ANSI, and specifies compiler options **-qansialias** (to allow type-based aliasing) and **-qolonglong** (disabling use of long long). Use this invocation for strict conformance to the *ISO/IEC 9899:1990* standard. This invocation is intended to provide the same compiler behavior as when invoked by the **c89** command name of the c89 utility.

**c99** Invokes the compiler for C source files, with a default language level of STDC99 and specifies compiler option **-qansialias** (to allow type-based aliasing). Use this invocation for strict conformance to the *ISO/IEC 9899:1999* standard.

#### **cxx/c++**

**cxx** and **c++** invoke the compiler for C++ language source code. Both are intended to provide the same compiler behavior as when invoked using the **cxx** and **c++** command names of the c89 utility.

You can combine the previously described command names with the following suffixes:

**\_x** Command invocations using command names with suffix **\_x** are the same as invocations using names without suffixes, except the **-qxplink** option is also specified and appropriate XPLINK libraries are used in the link step. If you are building an XPLINK application, you no longer need to use command names with suffix **\_x** to link with the correct run-time libraries. This can be achieved through the new configuration attributes that have been introduced to enable XPLINK behavior without the use of suffixes. See “Configuration file attributes” on page 531 for further information.

**\_64** Command invocations using command names with suffix **\_64** are the same as invocations using names without suffixes, except the **-q64** option is also specified and appropriate 64-bit libraries are used in the link step. If you are building a 64-bit application, you no longer need to use command names with suffix **\_64** to link with the correct run-time libraries. This can be achieved through the new configuration attributes that have been introduced to enable 64-bit behavior without the use of suffixes. See “Configuration file attributes” on page 531 for further information.

#### **Notes:**

1. Suffixes are used as a naming convention and do not enforce behavior. The content of the command line will take precedence over the suffixes.
2. When compiling and linking a C++ application using a single command line invocation, the application will be correctly link edited with any stanza if at least one C++ source file is specified on the command line. If only object files or a mix of C sources and C++ object files are specified on the command line, a C++ stanza must be used to correctly link edit the application.

---

## Setting up the compilation environment

Before you compile your C and C++ programs, you must set up the environment variables and the configuration file for your application. For more information on the configuration file, see “Setting up a configuration file” on page 531.

## Environment variables

You can use environment variables to specify necessary system information.

### Setting environment variables

Different commands are used to set the environment variables depending on whether you are using the z/OS UNIX System Services shell (sh), which is based on the Korn Shell and is upward-compatible with the Bourne shell, or tcsh shell, which is upward-compatible with the C shell. To determine the current shell, use the echo command, which is **echo \$SHELL**.

The z/OS UNIX System Services shell path is /bin/sh. The tcsh shell path is /bin/tcsh.

For more information about the NLSPATH and LANG environment variables, see *z/OS XL C/C++ Programming Guide* and *z/OS UNIX System Services Command Reference*.

### Setting environment variables in z/OS shell

The following statements show how you can set environment variables in the z/OS shell:

```
LANG=En_US
NLSPATH=/usr/lib/nls/msg/%L/%N:/usr/lib/nls/msg/%L/%N.cat
PATH=/bin:/usr/lpp/cbc/lib/xlc/bin${PATH:+:${PATH}}
export LANG NLSPATH PATH
```

To set the variables so that all users have access to them, add the commands to the file /etc/profile. To set them for a specific user only, add the commands to the .profile file in the user's home directory. The environment variables are set each time the user logs in.

### Setting environment variables in tcsh shell

The following statements show how you can set environment variables in the tcsh shell:

```
setenv LANG En_US
setenv NLSPATH /usr/lib/nls/msg/%L/%N:/usr/lib/nls/msg/%L/%N.cat
setenv PATH /bin:/usr/lpp/cbc/lib/xlc/bin${PATH:+:${PATH}}
```

To set the variables so that all users have access to them, add the commands to the file /etc/csh.cshrc. To set them for a specific user only, add the commands to the .tcshrc file in the user's home directory. The environment variables are set each time the user logs in.

### Setting environment variables for the message file

Before using the compiler, you must install the message catalogs and set the environment variables:

**LANG** Specifies the national language for message and help files.

#### NLSPATH

Specifies the path name of the message and help files.

#### XL\_CONFIG

Specifies the name of an alternative configuration file (.cfg) for the xlc utility.  
 Note: For the syntax of the configuration file, see the description for the -F flag option in "Flag options syntax" on page 540.

The LANG environment variable can be set to any of the locales provided on the system. See the description of locales in *z/OS XL C/C++ Programming Guide* for more information.

The national language code for United States English may be En\_US or C. If the Japanese message catalog has been installed on your system, you can substitute Ja\_JP for En\_US.

To determine the current setting of the national language on your system, see the output from both of the following echo commands:

- **echo \$LANG**
- **echo \$NLSPATH**

The LANG and NLSPATH environment variables are initialized when the operating system is installed, and may differ from the ones you want to use.

---

## Setting up a configuration file

The configuration file specifies information that the compiler uses when you invoke it. This file defines values used by the compiler to compile C or C++ programs. You can make entries to this file to support specific compilation requirements or to support other C or C++ compilation environments.

A configuration file is a UNIX file consisting of named sections called stanzas. Each stanza contains keywords called configuration file attributes, which are assigned values. The attributes are separated from their assigned value by an equal sign. A stanza can point to a default stanza by specifying the "use" keyword. This allows specifying common attributes in a default stanza and only the deltas in a specific stanza, referred to as the local stanza.

For any of the supported attributes not found in the configuration file, the xlc utility uses the built-in defaults. It uses the first occurrence in the configuration file of a stanza or attribute it is looking for. Unsupported attributes, and duplicate stanzas and attributes are not diagnosed.

**Note:** The difference between specifying values in the stanza and relying on the defaults provided by the xlc utility is that the defaults provided by the xlc utility will not override pragmas.

## Configuration file attributes

A stanza in the configuration file can contain the following attributes:

|                     |   |
|---------------------|---|
| <b>as</b>           | Path name to be used for the assembler. The default is /bin/c89.  |
| <b>asopt</b>        | The list of options for the assembler and not for the compiler. These override all normal processing by the compiler and are directed to the assembler specified in the as attribute. Options are specified following the c89 utility syntax. |
| <b>asuffix</b>      | The suffix for archive files. The default is a.   |
| <b>asuffix_host</b> | The suffix for archive data sets. The default is LIB.   |
| <b>ccomp</b>        | The C compiler. The default is usr/lpp/cbclib/xlc/exe/ccndrvr.  |
| <b>cinc</b>         | A comma separated list of directories or data set wild cards used to search for C header files. The default for this attribute is: -I//CEE.SCEEH.+'. For further information on the list of search  |

places used by the compiler to search for system header files, see the note at the end of this list of configuration file attributes.

- | **classversion** The USL class library version. The default matches the current  
| release, as described in “TARGET” on page 198.
- cppcomp** The C++ compiler. The default is /usr/lpp/cbclib/xlc/exe/ccndrvr.
- cppinc** A comma separated list of directories or data set wild cards used to  
search for C++ header files. The default for this attribute is:  
-I//CEE.SCEEH.+’,-I//CBC.SCLBH.+’.For further information on the  
list of search places used by the compiler to search for system  
header files, see the note at the end of this list of configuration file  
attributes.
- csuffix** The suffix for source programs. The default is c (lowercase c).
- csuffix\_host** The suffix for C source data sets. The default is C (uppercase C).
- | **cversion** The compiler version. The default matches the current release, as  
| described in “TARGET” on page 198. The oldest release supported  
| is z/OS V1R6.
- cxxsuffix** The suffix for C++ source files. The default is C (uppercase C).
- cxxsuffix\_host**  
The suffix for C++ source data sets. The default is CXX.
- exportlist** A colon separated list of data sets with member names indicating  
definition side-decks to be used to resolve symbols during the  
link-editing phase. This attribute is only used for compatibility with  
configuration files that are defined using the z/OS V1R6 release.  
Attributes with an appropriate suffix should be used instead (see  
descriptions for `exportlist` attributes with a suffix). The default for  
this attribute should match the type of stanza for which it is  
specified.  
  
Suffix-less C stanzas do not have a default.  
  
The default for suffix-less C++ stanzas is:  
CEE.SCEELIB(C128N):CBC.SCLBSID(IOSTREAM,COMPLEX)  
  
The default for C stanzas with an `_x` suffix is:  
CEE.SCEELIB(CELHS003,CELHS001)  
  
The default for C++ stanzas with an `_x` suffix is:  
CEE.SCEELIB(CELHS003,CELHSCPP,CELHS001,C128):CBC.SCLBSID  
(IOSTREAM,COMPLEX)  
  
The default for C stanzas with a `_64` suffix is:  
CEE.SCEELIB(CELQS003)  
  
The default for C++ stanzas with a `_64` suffix is:  
CEE.SCEELIB(CELQS003,CELQSCPP,C64):CBC.SCLBSID(IOSQ64)
- exportlist\_c** A colon separated list of data sets with member names indicating  
definition side-decks to be used to resolve symbols during the  
link-editing phase of non-XPLINK C applications. The default for this  
attribute is NONE.
- exportlist\_cpp**  
A colon separated list of data sets with member names indicating



definition side-decks to be used to resolve symbols during the link-editing phase of non-XPLINK C++ applications. The default for this attribute is:

```
CEE.SCEELIB(C128n):CBC.SCLBSID(IOSTREAM,COMPLEX)
```

#### **exportlist\_c\_x**

A colon separated list of data sets with member names indicating definition side-decks to be used to resolve symbols during the link-editing phase of XPLINK C applications. The default for this attribute is:

```
CEE.SCEELIB(CELHS003,CELHS001)
```

#### **exportlist\_cpp\_x**

A colon separated list of data sets with member names indicating definition side-decks to be used to resolve symbols during the link-editing phase of XPLINK C++ applications. The default for this attribute is:

```
CEE.SCEELIB(CELHS003,CELHSCPP,CELHS001,C128):CBC.SCLBSID(IOSTREAM,COMPLEX)
```

#### **exportlist\_c\_64**

A colon separated list of data sets with member names indicating definition side-decks to be used to resolve symbols during the link-editing phase of 64-bit C applications. The default for this attribute is:

```
CEE.SCEELIB(CELQS003)
```

#### **exportlist\_cpp\_64**

A colon separated list of data sets with member names indicating definition side-decks to be used to resolve symbols during the link-editing phase of 64-bit C++ applications. The default for this attribute is:

```
CEE.SCEELIB(CELQS003,CELQSCPP,C64):CBC.SCLBSID(IOSQ64)
```

#### **isuffix**

The suffix for C preprocessed files. The default is i.

#### **isuffix\_host**

The suffix for C preprocessed data sets. The default is CEX.

#### **ilsuffix**

The suffix for IPA output files. The default is I.

#### **ilsuffix\_host**

The suffix for IPA output data sets. The default is IPA.

#### **ixxsuffix**

The suffix for C++ preprocessed files. The default is i.

#### **ixxsuffix\_host**

The suffix for C++ preprocessed data sets. The default is CEX.

#### **ld**

The path name to be used for the binder. The default is /bin/c89.

#### **ld\_c**

The path name to be used for the binder when only C sources appear on the command line invoked with a C stanza. The default is: /bin/c89.

#### **ld\_cpp**

The path name to be used for the binder when at least one C++ source appears on the command line, or when a C++ stanza is used. The default is: /bin/cxx.

#### **libraries2**

libraries2 specifies the libraries that the binder is to use at bind time. The default is empty.

#### **options**

A string of option flags, separated by commas, to be processed by the compiler as if they had been entered on the command line.

## xlc and xlc

|                     |  |
|---------------------|--|
| <b>osuffix</b>      | The suffix for object files. The default is .o.  |
| <b>osuffix_host</b> | The suffix for object data sets. The default is OBJ.   |
| <b>psuffix</b>      | The suffix for prelinked files. The default is p.  |
| <b>psuffix_host</b> | The suffix for prelinked data sets. The default is CPOBJ.  |
| <b>pversion</b>     | The run-time library version. The default matches the current release, as described in “TARGET” on page 198.   |
| <b>ssuffix</b>      | The suffix for assembler files. The default is .s.   |
| <b>ssuffix_host</b> | The suffix for assembler data sets. The default is ASM.  |
| <b>steplib</b>      | A colon separated list of data sets or keyword NONE used to set the STEPLIB environment variable. The default is NONE, which causes all programs to be loaded from LPA or linklist.  |
| <b>syslib</b>       | <p>A colon separated list of data sets used to resolve run-time library references. Data sets from this list are used to construct the SYSLIB DD for the IPA Link and the binder invocation for non-XPLINK applications. For compatibility with configuration files defined using the z/OS V1R6 release, this attribute is also used with XPLINK applications as a fallback when the <code>syslib_x</code> attribute is not specified. When the <code>syslib_x</code> attribute is not specified, the default for this attribute should match the type of stanza for which it is specified. When the <code>syslib_x</code> attribute is specified, the default for this attribute matches the default for suffix-less stanzas.</p> <p>The default for suffix-less stanzas is:<br/>CEE.SCEELKEX:CEE.SCEELKED:CBC.SCCNOBJ:SYS1.CSSLIB</p> <p>The default for stanzas with <code>_x</code> and <code>_64</code> suffixes is:<br/>CEE.SCEEBND2:CBC.SCCNOBJ:SYS1.CSSLIB</p> |
| <b>syslib_x</b>     | <p>A colon separated list of data sets used to resolve run-time library references. Data sets from this list are used to construct the SYSLIB DD for the IPA Link and the binder invocation when building XPLINK applications (31-bit and 64-bit).</p> <p>The default for this attribute is:<br/>CEE.SCEEBND2:CBC.SCCNOBJ:SYS1.CSSLIB</p>  |
| <b>sysobj</b>       | <p>A colon separated list of data sets containing object files used to resolve run-time library references. Data sets from this list are used to construct the LIBRARY control statements and the SYSLIB DD for the IPA Link and the binder invocation. This attribute is ignored for XPLINK and 64-bit applications.</p> <p>The default is:<br/>CEE.SCEE0BJ:CEE.SCEECPP</p>   |
| <b>use</b>          | Values for attributes are taken from the named stanza and from the local stanza. For single-valued attributes, values in the use stanza apply if no value is provided in the local, or default stanza. For comma-separated lists, the values from the use stanza are added to the values from the local stanza.  |
| <b>xlc</b>          | The path name of the C++ compiler invocation command. The default is /usr/lpp/cbclib/xlc/bin/xlc.  |

|                     |  |
|---------------------|--|
| <b>xICcopt</b>      | A string of option flags, separated by commas, to be processed when the <b>xlc</b> command is used for compiling a C file. |
| <b>xsuffix</b>      | The suffix for definition side-deck files. The default is <b>x</b> .   |
| <b>xsuffix_host</b> | The suffix for definition side-deck data sets. The default is <b>EXP</b> .   |

**Note:** When using the **xlc** utility to invoke the compiler, the compiler uses the following list of search places to search for system header files:

- If the **-qnosearch** option is not specified on the command line or in the configuration file:
  1. search places defined in the customizable defaults module (CCNEDFLT)
  2. followed by those specified on the command line using the **-I** flag option
  3. followed by those specified in the configuration file
- If the **-qnosearch** is specified only in the configuration file:
  1. search places specified on the command line using the **-I** flag option
  2. followed by those specified in the configuration file
- If the **-qnosearch** option is specified on the command line:
  1. search places specified on the command line following the last specified **-qnosearch** option
  2. followed by those specified in the configuration file

## Tailoring a configuration file

The default configuration file is installed in `/usr/lpp/cbclib/xlc/etc/xlc.cfg`.

You can copy this file and make changes to the copy to support specific compilation requirements or to support other C or C++ compilation environments. The **-F** option is used to specify a configuration file other than the default. For example, to make **-qnor** the default for the **xIC** compiler invocation command, add **-qnor** to the **xIC** stanza in your copied version of the configuration file.

You can link the compiler invocation command to several different names. The name you specify when you invoke the compiler determines which stanza of the configuration file the compiler uses. You can add other stanzas to your copy of the configuration file to customize your own compilation environment.

**Example:** You can use the **-F** option with the compiler invocation command to make links to select additional stanzas or to specify a stanza or another configuration file:

```
xlc myfile.C -Fmyconfig:SPECIAL
```

would compile `myfile.C` using the `SPECIAL` stanza in a `myconfig` configuration file that you had created.

## Default configuration file

The default configuration file, (`/usr/lpp/cbclib/xlc/etc/xlc.cfg`), specifies information that the compiler uses when you invoke it. This file defines values used by the compiler to compile C or C++ programs. You can make entries to this file to support specific compilation requirements or to support other C or C++ compilation environments. Options specified in the configuration file override the default settings of the option. Similarly, options specified in the configuration file are in turn

overridden by options set in the source file and on the command line. Options that do not follow this scheme are listed in “Specifying compiler options” on page 543.

**Example:** The following example shows a default configuration file:

```

*
* FUNCTION: z/OS 1.8 XL C/C++ Compiler Configuration file
*
* Licensed Materials - Property of IBM
* 5694-A01 (C) Copyright IBM Corp. 2004, 2006
* All Rights Reserved
* US Government Users Restricted Rights - Use, duplication or
* disclosure restricted by GSA ADP Schedule Contract with IBM Corp.
*
* C compiler, extended mode
xlc:      use          = DEFLT

* XPLINK C compiler, extended mode
xlc_x:    use          = DEFLT

* 64 bit C compiler, extended mode
xlc_64:   use          = DEFLT

* C compiler, common usage C
cc:       use          = DEFLT

* XPLINK C compiler, common usage C
cc_x:     use          = DEFLT

* 64 bit C compiler, common usage C
cc_64:    use          = DEFLT

* Strict ANSI C 89 compiler
c89:      use          = DEFLT

* XPLINK Strict ANSI C 89 compiler
c89_x:    use          = DEFLT

* 64 bit Strict ANSI C 89 compiler
c89_64:   use          = DEFLT

* ISO/IEC 9899:1999 Standard Compliant C Compiler
c99:      use          = DEFLT

* XPLINK ISO/IEC 9899:1999 Standard Compliant C Compiler
c99_x:    use          = DEFLT

* 64 bit ISO/IEC 9899:1999 Standard Compliant C Compiler
c99_64:   use          = DEFLT

* ANSI C++ compiler
cxx:      use          = DEFLT
          xlc          = /usr/lpp/cbclib/xlc/bin/.orig/xlc
          ipa          = /bin/cxx

* XPLINK ANSI C++ compiler
cxx_x:    use          = DEFLT
          xlc          = /usr/lpp/cbclib/xlc/bin/.orig/xlc
          ipa          = /bin/cxx

* 64 bit ANSI C++ compiler
cxx_64:   use          = DEFLT
          xlc          = /usr/lpp/cbclib/xlc/bin/.orig/xlc
          ipa          = /bin/cxx

* ANSI C++ compiler
c++:      use          = DEFLT

```

```

xlc          = /usr/lpp/cbclib/xlc/bin/.orig/xlc
ipa         = /bin/cxx

* XPLINK ANSI C++ compiler
c++_x:      use      = DEFLT
           xlc      = /usr/lpp/cbclib/xlc/bin/.orig/xlc
           ipa      = /bin/cxx

* 64 bit ANSI C++ compiler
c++_64:     use      = DEFLT
           xlc      = /usr/lpp/cbclib/xlc/bin/.orig/xlc
           ipa      = /bin/cxx

* C++ compiler, extended mode
xlc:        use      = DEFLT
           xlc      = /usr/lpp/cbclib/xlc/bin/.orig/xlc
           ipa      = /bin/cxx

* XPLINK C++ compiler, extended mode
xlc_x:      use      = DEFLT
           xlc      = /usr/lpp/cbclib/xlc/bin/.orig/xlc
           ipa      = /bin/cxx

* 64 bit C++ compiler, extended mode
xlc_64:     use      = DEFLT
           xlc      = /usr/lpp/cbclib/xlc/bin/.orig/xlc
           ipa      = /bin/cxx

* C++ compiler, extended mode
xlc++:      use      = DEFLT
           xlc      = /usr/lpp/cbclib/xlc/bin/.orig/xlc
           ipa      = /bin/cxx

* XPLINK C++ compiler, extended mode
xlc++_x:    use      = DEFLT
           xlc      = /usr/lpp/cbclib/xlc/bin/.orig/xlc
           ipa      = /bin/cxx

* 64 bit C++ compiler, extended mode
xlc++_64:  use      = DEFLT
           xlc      = /usr/lpp/cbclib/xlc/bin/.orig/xlc
           ipa      = /bin/cxx

* common definitions
DEFLT:      cppcomp   = /usr/lpp/cbclib/xlc/exe/ccndrvr
           ccomp     = /usr/lpp/cbclib/xlc/exe/ccndrvr
           ipacomp   = /usr/lpp/cbclib/xlc/exe/ccndrvr
           as        = /bin/c89
           ld_c      = /bin/c89
           ld_cpp    = /bin/cxx
           xlc       = /usr/lpp/cbclib/xlc/bin/xlc
           xlccopt   = -D_XOPEN_SOURCE
           sysobj    = cee.sceobj:cee.sceecpp
           syslib    = cee.sceelkex:cee.sceelked:cbc.sccnobj:sys1.csslib
           syslib_x  = cee.sceebnd2:cbc.sccnobj:sys1.csslib
           exportlist_c = NONE
           exportlist_cpp = cee.sceelib(c128n):cbc.sclbsid(iostream,complex)
           exportlist_c_x = cee.sceelib(celhs003,celhs001)
           exportlist_cpp_x = cee.sceelib(celhs003,celhs001,celhscpp,c128):
           cbc.sclbsid(iostream,complex)
           exportlist_c_64 = cee.sceelib(celqs003)
           exportlist_cpp_64 = cee.sceelib(celqs003,celqscpp,c64):cbc.sclbsid(iosx64)
           steplib   = NONE

```

---

## Invoking the compiler

The z/OS XL C/C++ compiler is invoked using the following syntax, where *invocation* can be replaced with any valid z/OS XL C/C++ invocation command:

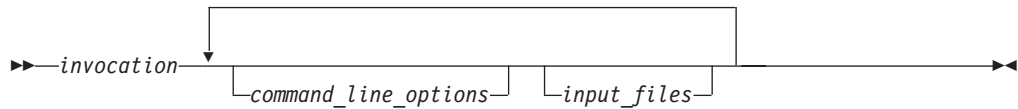

The parameters of the compiler invocation command can be names of input files, compiler options, and linkage-editor options. Compiler options perform a wide variety of functions such as setting compiler characteristics, describing object code and compiler output to be produced, and performing some preprocessor functions.

To compile without binding, use the **-c** compiler option. The **-c** option stops the compiler after compilation is completed and produces as output, an object file *file\_name.o* for each *file\_name.c* input source file, unless the **-o** option was used to specify a different object filename. The binder is not invoked. You can bind the object files later using the invocation command, specifying the object files without the **-c** option.

### Notes:

1. Any object files produced from an earlier compilation with the same name as expected object files in this compilation are deleted as part of the compilation process, even if new object files are not produced.
2. By default, the invocation command calls both the compiler and the binder. It passes binder options to the binder. Consequently, the invocation commands also accept all binder options.

---

## Invoking the binder

All invocation commands invoke the binder using the *c89* utility, so all binder options must follow the syntax supported by the *c89* utility. Standard libraries required to bind your program are controlled by the *sysobj*, *syslib*, and *exportlist* attributes in the configuration file.

The specified object files are processed by the binder to create one executable file. Invoking the compiler with one of the invocation commands, automatically calls the binder unless you specify one of the following compiler options: **-E**, **-c**, **-P**, **-qsyntaxonly**, **-qpponly**, or **-#**.

All input and output files supported by the *c89* utility are valid for all invocation commands.

---

## Supported options

In addition to **-W** syntax for specifying keyword options, the *xlc* utility supports AIX **-q** options syntax and several new flag options.

### -q options syntax

The following principles apply to the use of z/OS option names with **-q** syntax:

- Any valid abbreviation of a z/OS option name that matches (in full or in part) the spelling of the corresponding option on AIX, can be specified using **-q** syntax. For

example, ATTRIBUTE can be specified as **-qatt**, **-qattr**, **-qattri**, **-qattrib**, **-qattribu**, **-qattribut**, and **-qattribute**. This is true even if the AIX option name is longer, as in the case of **-qbitfields**, which can be specified as **-qbitf**, **-qbitfi**, **-qbitfie**, **-qbitfiel**, **-qbitfield**, and **-qbitfields**. This is the common case that applies to most z/OS options.

- Any z/OS-specific option name and its valid abbreviation can also be specified using **-q** syntax; for example, DBRMLIB.
- Any z/OS option name that has a different spelling from the corresponding AIX option name can not be specified using **-q** syntax. For example, CHECKOUT, EXH, ILP32, LP64, SSCOMM, and TEST can not be specified using **-q** syntax. Instead use, **-qinfo**, **-qeh**, **-q32**, **-q64**, **-qcpluscmt**, and **-qdebug=format=isd**. For historical reasons, OBJECTMODEL and PHASEID are exceptions to this principle, as both can be specified using **-q** syntax. However, **-qobjmodel** and **-qphsinfo** should be used instead to enhance portability with AIX.

Options that do not exist on AIX, and are not required to accomplish a z/OS-specific task, and their effect can be accomplished by other means, are not supported with **-q** syntax. For example, use **-D** instead of DEFINE, **-U** instead of UNDEFINE, and **-co** instead of OBJECT.

Suboptions with negative forms of **-q** options are not supported, unless they cause an active compiler action, as in the case of **-qnokeyword=<keyword>**.

Compiler options for AIX that do not apply to z/OS are accepted and ignored with a diagnostic message. For a brief description of the compiler options that can be specified with xlc, type **xlc** or any other supported command name. For detailed descriptions of the compiler options that can be specified with xlc, refer to Chapter 4, "Compiler Options," on page 45.

The following syntax diagram shows how to specify keyword options using **-q** syntax:

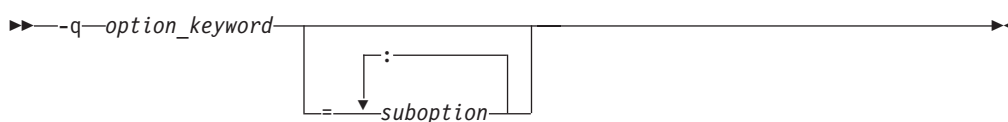

In the diagram, *option\_keyword* is an option name and the optional *suboption* is a value associated with the option. Keyword options with no suboptions represent switches that may be either on or off. The *option\_keyword* by itself turns the switch on, and the *option\_keyword* preceded by the letters NO turns the switch off. For example, **-qLIST** tells the compiler to produce a listing and **-qNOLIST** tells the compiler not to produce a listing. If an option that represents a switch is set more than once, the compiler uses the last setting.

Some keyword options only have values. Keywords which have values are specified as keyword=value pairs.

#### Example:

```
-qfloat=ieee
```

where *ieee* is a value.





**Notes:**

1. The optional prefix defines part of a path name to the new programs. The compiler does not add a / between the prefix and the program name.
2. To form the complete path name for each program, the xlc utility adds prefix to the program names indicated by the **-t** option. The program names can be any combination of z/OS XL C/C++ compiler, assembler, IPA Link and binder.
3. If **-Bprefix** is not specified, or if **-B** is specified without the prefix, the default path (/usr/lpp/cbclib/xlc/bin/) is used.
4. **-tprograms** specifies the programs for which the path name indicated by the **-B** option is to be applied.
5. **-Bprefix** and **-tprograms** options override the path names of the programs that are specified inside the configuration file indicated by the **-Fconfig\_file** option.

**Example:** To compile myprogram.c using a substitute compiler and binder from /lib/tmp/mine/, enter:

```
xlc myprogram.c -B/lib/tmp/mine/
```

**Example:** To compile myprogram.c using a substitute binder from /lib/tmp/mine/, enter:

```
xlc myprogram.c -B/lib/tmp/mine/ -t1
```

**-F** Names an alternative configuration file (.cfg) for the xlc utility.

Suboptions are:

- *config\_file* (specifies the name of an xlc configuration file.)
- *stanza* (specifies the name of the command used to invoke the compiler. This directs the compiler to use the entries under *stanza* in the *config\_file* to set up the compiler environment.)

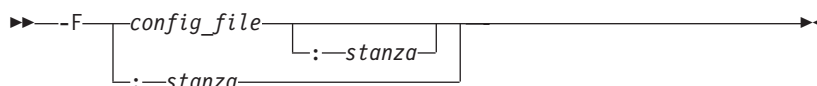
**Notes:**

1. The default configuration file supplied at installation time is called /usr/lpp/cbclib/xlc/etc/xlc.cfg. Any file names or stanzas that you specify on the command line override the defaults specified in the /usr/lpp/cbclib/xlc/etc/xlc.cfg configuration file.
2. The **-B**, **-t**, and **-W** options override entries in the configuration file indicated by the **-F** option.

**Example:** To compile myprogram.c using a configuration file called /usr/tmp/mycbc.cfg, enter:

```
xlc myprogram.c -F/usr/tmp/mycbc.cfg
```

**-O** Optimizes generated code.



**-O2** Same as **-O**.

## xlc and xlc

►► -O2 ◄◄

**-O3** Performs some memory and compile time intensive optimizations in addition to those executed with -O2. The -O3 specific optimizations have the potential to alter the semantics of a user's program. The compiler guards against these optimizations at -O2 and the option **-qstrict** is provided at -O3 to turn off these aggressive optimizations.

►► -O3 ◄◄

|

**-O4** Equivalent to -O3 **-qipa** and **-qhot**.

►► -O4 ◄◄

|

**-O5** Equivalent to -O3 **-qipa=level=2** and **-qhot**.

►► -O5 ◄◄

|

**-P** Produces preprocessed output in a file that has a suffix that is defined by `isuffix`, `isuffix_host`, `ixxsuffix`, and `ixxsuffix_host`. The default for host files is `.CEX` and for z/OS UNIX files is `.i`.

As with the -E option, the -C option can be combined with the -P option to preserve the comments.

**-t** Adds the prefix specified by the -B option to the designated programs, where programs are:

- a (assembler)
- c (z/OS XL C/C++ compiler)
- L (Interprocedural Analysis tool - link phase)
- l (binder)



**Note:** This option must be used together with the -B option.

If -B is specified but the prefix is not, the default prefix is `/usr/lpp/cbclib/xlc/bin/`. If **-Bprefix** is not specified at all, the prefix of the standard program names is `/usr/lib/cbclib/xlc/bin/`.

If -B is specified but **-tprograms** is not, the default is to construct path names for all of the standard program names: a, c, L, and l.

**Example:** To compile `myprogram.c` so that the name `/u/new/compilers/` is prefixed to the binder and assembler program names, enter:

```
xlc myprogram.c -B/u/new/compilers/ -tla
```

- W** Passes the listed options to a designated compiler program where programs are:
- a (assembler)
  - c (z/OS XL C/C++ compiler)
  - I (Interprocedural Analysis tool - compile phase)
  - l (binder)

**Note:** When used in the configuration file, the **-W** option requires the escape sequence back slash comma (\,) to represent a comma in the parameter string.

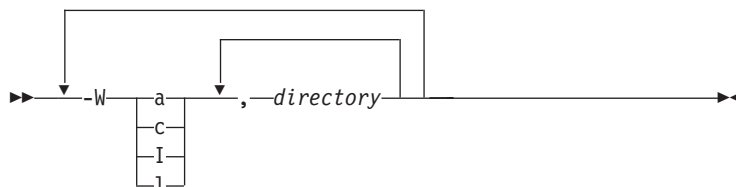

**Example:** To compile myprogram.s so that the option **map** is passed to the binder and the option list is passed to the assembler, enter:

```
xlc myprogram.s -Wl,map -Wa,list
```

**Example:** In a configuration file, use the \, sequence to represent the comma (,):

```
-Wl\,map,-Wa\,list
```

## Specifying compiler options

Compiler options perform a wide variety of functions, such as setting compiler characteristics, describing the object code and compiler output to be produced, and performing some preprocessor functions. You can specify compiler options in one or more of the following ways:

- On the command line
- In your source program
- In a configuration file

The compiler uses default settings for the compiler options not explicitly set by you in the ways listed above. The defaults can be compiler defaults, installation defaults, or the defaults set by the c89 or the xlc utility. The compiler defaults are overridden by installation defaults, which are overridden by the defaults set by the c89 or the xlc utilities.

When specifying compiler options, it is possible for option conflicts and incompatibilities to occur. z/OS XL C/C++ resolves most of these conflicts and incompatibilities in a consistent fashion, as follows:

|             |           |              |           |                    |           |                  |
|-------------|-----------|--------------|-----------|--------------------|-----------|------------------|
| Source file | overrides | Command line | overrides | Configuration file | overrides | Default settings |
|             | ----->    |              | ----->    |                    | ----->    |                  |

Options that do not follow this scheme are summarized in the following table:

Table 45. Compiler option conflict resolution

| Option | Conflicting Options   | Resolution                 |
|--------|---|----------------------------|
| -qxref | -qxref=FULL   | -qxref=FULL                |
| -qattr | -qattr=FULL   | -qattr=FULL                |
| -E     | -o  | -E                         |
| -#     | -v  | -#                         |
| -F     | -B   -t   -W   -qpath  <br><i>configuration file settings</i> | -B   -t   -W   -qpath      |
| -qpath | -B   -t   | -qpath overrides -B and -t |

In general, if more than one variation of the same option is specified (with the exception of xref and attr), the compiler uses the setting of the last one specified. Compiler options specified on the command line must appear in the order you want the compiler to process them.

If a command-line flag is valid for more than one compiler program (for example -B, -W, or -I applied to the compiler, binder, and assembler program names), you must specify it in options, or asopt in the configuration file. The command-line flags must appear in the order that they are to be directed to the appropriate compiler program.

Three exceptions to the rules of conflicting options are the *-ldirectory* or *-I//dataset\_name*, *-llibrary*, and *-Ldirectory* options, which have cumulative effects when they are specified more than once.

## Specifying compiler options on the command line

There are two kinds of command-line options:

- **-qoption\_keyword** (compiler-specific)
- Flag options (available to z/OS XL C/C++ compilers in z/OS UNIX System Service environment)

Command-line options in the **-q option\_keyword** format are similar to on and off switches. For most **-q** options, if a given option is specified more than once, the last appearance of that option on the command line is the one recognized by the compiler. For example, **qsource** turns on the source option to produce a compiler listing, and **-qnosource** turns off the source option so that no source listing is produced.

**Example:** The following example would produce a source listing for both MyNewProg.C and MyFirstProg.C because the last source option specified (**-qsource**) takes precedence:

```
xlc -qnosource MyFirstProg.C -qsource MyNewProg.C
```

You can have multiple **-q option\_keyword** instances in the same command line, but they must be separated by blanks. Option keywords can appear in mixed case, but you must specify the **-q** in lowercase.

**Example:** You can specify any **-q option\_keyword** before or after the file name:

```
xlc -qLIST -qnomaf file.c
xlc file.c -qxref -qsource
```

Some options have suboptions. You specify these with an equal sign following the **-qoption**. If the option permits more than one suboption, a colon (:) must separate each suboption from the next.

**Example:** The following example compiles the C source file `file.c` using the option **-qipa** to specify the inter procedural analysis options. The suboption `level=2` tells the compiler to use the full inter procedural data flow and alias analysis, **map** tells the compiler to produce a report, and the **noobj** tells the compiler to produce only an IPA object without a regular object. The option **-qattr** with suboption `full` will produce an attribute listing of all identifiers in the program.

```
xlc -qipa=level=2:map:noobj -qattr=full file.c
```

## Specifying flag options

The z/OS XL C/C++ compilers use a number of common conventional flag options. Lowercase flags are different from their corresponding uppercase flags. For example, **-c** and **-C** are two different compiler options:

- **-c** specifies that the compiler should only preprocess, compile, and not invoke the binder
- **-C** can be used with **-E** or **-P** to specify that user comments should be preserved

Some flag options have arguments that form part of the flag.

**Example:**

```
xlc stem.c -F/home/tools/test3/new.cfg:myc -qflag=w
```

where `new.cfg` is a custom configuration file.

You can specify flags that do not take arguments in one string.

**Example:**

```
xlc -0cv file.c
```

has the same effect as:

```
xlc -0 -v -c test.c
```

## Specifying compiler options in a configuration file

The default configuration file, (`/usr/lpp/cbclib/xlc/etc/xlc.cfg`), specifies information that the compiler uses when you invoke it. This file defines values used by the compiler to compile C or C++ programs. You can make entries to this file to support specific compilation requirements or to support other C or C++ compilation environments.

Options specified in the configuration file override the default settings of the option. Similarly, options specified in the configuration file are in turn overridden by options set in the source file and on the command line.

## Specifying compiler options in your program source files

You can specify compiler options within your program source by using `#pragma` directives. Options specified with `pragma` directives in program source files override all other option settings.

## Specifying compiler options for architecture-specific 32-bit or 64-bit compilation

You can use z/OS XL C/C++ compiler options to optimize compiler output for use on specific processor architectures. You can also instruct the compiler to compile in either 32-bit or 64-bit mode.

The compiler evaluates compiler options in the following order, with the last allowable one found determining the compiler mode:

1. Compiler default (32-bit mode)
2. Configuration file settings
3. Command line compiler options (**-q32**, **-q64**, **-qarch**, **-qtune**)
4. Source file statements (**#pragma options(ARCH(suboption),TUNE(suboption))**)

The compilation mode actually used by the compiler depends on a combination of the settings of the **-q32**, **-q64**, **-qarch**, and **-qtune** compiler options, subject to the following conditions:

- Compiler mode is set according to the last-found instance of the **-q32**, or **-q64** compiler options. If neither of these compiler options is chosen, the compiler mode is set to 32-bit.
- Architecture target is set according to the last-found instance of the **-qarch** compiler option, provided that the specified **-qarch** setting is compatible with the compiler mode setting. If the **-qarch** option is not set, the compiler assumes a **-qarch** setting of 5.
- Tuning of the architecture target is set according to the last-found instance of the **-qtune** compiler option, provided that the **-qtune** setting is compatible with the architecture target and compiler mode settings. If the **-qtune** option is not set, the compiler assumes a default **-qtune** setting according to the **-qarch** setting in use.

Possible option conflicts and compiler resolution of these conflicts are described below:

- **-q32** or **-q64** setting is incompatible with user-selected **-qarch** option.  
Resolution: **-q32** or **-q64** setting overrides **-qarch** option; compiler issues a warning message, sets **-qarch** to 5, and sets the **-qtune** option to the **-qarch** setting's default **-qtune** value.
- **-q32** or **-q64** setting is incompatible with user-selected **-qtune** option.  
Resolution: **-q32** or **-q64** setting overrides **-qtune** option; compiler issues a warning message, and sets **-qtune** to the **-qarch** settings's default **-qtune** value.
- **-qarch** option is incompatible with user-selected **-qtune** option.  
Resolution: Compiler issues a warning message, and sets **-qtune** to the **-qarch** setting's default **-qtune** value.
- Selected **-qarch** and **-qtune** options are not known to the compiler.  
Resolution: Compiler issues a warning message, sets **-qarch** to 5, and sets **-qtune** to the **-qarch** setting's default **-qtune** setting. The compiler mode (32 or 64-bit) is determined by the **-q32** or **-q64** compiler settings.

---

## Part 6. Appendixes





---

## Appendix A. Prelinking and linking z/OS XL C/C++ programs

Instead of using the prelinker and linkage editor, you can use the binder. See Chapter 9, “Binding z/OS XL C/C++ programs,” on page 355 for more information.

This chapter shows how to prelink and link your programs under z/OS with z/OS Language Environment. The z/OS Language Environment prelinker combines the object modules that comprise a C or C++ application into a single object module. The linkage editor then processes this object module and generates a load module that can be retrieved for execution.

You do not need to prelink object modules that:

- Do not refer to writable static
- Do not contain long names
- Do not contain DLL code

You must use the z/OS Language Environment prelinker before linking your application when any of the following are true:

- Your application contains C++ code.
- Your application contains C code that is compiled with the RENT, LONGNAME, DLL, or IPA compiler options.
- Your application is compiled to run under z/OS UNIX System Services.

If you do not need to prelink your application, continue to the information in “Linking an application” on page 554. For information on creating object libraries in z/OS XL C++, refer to Chapter 13, “Object library utility,” on page 437. For information on prelinking and linking object modules under z/OS UNIX System Services, refer to “Prelinking and link-editing under the z/OS Shell” on page 580.

**Note:** When you use the prelinker to prelink C++ object modules, you may get duplicate symbol warnings due to virtual function symbols generated by the compiler. You can ignore these symbols and warnings. You will not get these messages if you use the binder.

---

### Restrictions on using the prelinker

You cannot use the prelinker if you specified either the XPLINK or GOFF compiler option when you compiled.

**Note:** The prelinker cannot be used for 64-bit compiled object modules, therefore you cannot use the prelinker if any of the object modules were compiled using the LP64 option.

---

### Prelinking an application

To prelink multiple object modules and then link with a load module, you must run the multiple object modules through the prelinker and add the load module in the link step (for example, when prelinking and linking a CICS program).

You must prelink together all components that require prelinking prior to linking. For example, `LINK(PRELINK(XOBJ1,XOBJ2))` and `LINK(PRELINK(XOBJ1,XOBJ2),OBJ3)` are valid but `LINK(PRELINK(XOBJ1), PRELINK(XOBJ2))` is not. The prelinker only handles a subset of what the linker handles, in particular, it does not understand load modules (or program objects).

For object modules with writable static references:

- The prelinker combines writable static initialization information
- The prelinker assigns relative offsets to objects in writable static storage
- The prelinker removes writable static name and relocation information

For object modules that contain long names, the prelinker maps long names to short names on output. Long names are mixed-case external names of up to 1024 characters. Short names are eight character, uppercase external names.

For object modules that contain DLL code (C++ code, or C code that was compiled with the DLL compiler option), the prelinker does the following:

- It generates a function descriptor (linkage section) in writable static for each DLL referenced function
- It generates a variable descriptor (linkage section) for each unresolved DLL referenced variable
- It generates an IMPORT control statement in the SYSDEFSD data set for each exported function and variable
- It generates internal information for the load module that describes which symbols are exported and which symbols are imported from other load modules
- It combines static DLL initialization information

z/OS Language Environment Library functions are not included as part of automatic library calls. This omission can result in warning messages about unresolved references to C library functions or C library objects. These unresolved C library functions or objects will be resolved in a following link-edit step.

For C or C++ object modules from applications that were compiled with the DLL compiler option, the prelinker uses long names to resolve exported and imported symbols. For information on how to create a DLL or an application that uses DLLs, see *z/OS XL C/C++ Programming Guide*.

## Using DD Statements for the standard data sets - prelinker

The prelinker always requires three standard data sets. You must define these data sets in DD statements with the ddnames SYSIN, SYSMOD, and SYSMSGs.

You may need five other data sets that are defined by DD statements with the names STEPLIB, SYSLIB, SYSDEFSD, SYSOUT, and SYSPRINT. For a list of the data sets and their usage see Table 46. For details on the attributes of specific data sets see “Description of data sets used” on page 424.

Table 46. Data sets used for prelinking

| ddname                | Type            | Function   |
|-----------------------|-----------------|--|
| SYSIN                 | Input           | Primary input data, usually the output of the compiler                 |
| SYSMSGs               | Input           | Location of prelinker message file                                     |
| STEPLIB <sup>2</sup>  | Utility Library | Location of prelinker and z/OS Language Environment run-time data sets |
| SYSLIB                | Library         | Secondary input  |
| SYSDEFSD <sup>1</sup> | Output          | Definition side-deck   |
| SYSOUT                | Output          | Prelinker Map  |
| SYSMOD                | Output          | Output data set for the prelinked object module                        |

Table 46. Data sets used for prelinking (continued)

| ddname   | Type   | Function   |
|--|--------|--|
| SYSPRINT   | Output | Destination of error messages generated by the prelinker |
| User-specified   | Input  | Obtain additional object modules and load modules        |
| <b>Notes:</b><br><sup>1</sup> Required output from the prelinker if you are exporting variables or functions.<br><sup>2</sup> Optional data sets, if the compiler and run-time library are installed in the LPA or ELPA. To save resources and improve compile time, especially in z/OS UNIX System Services, do not unnecessarily specify data sets on the STEPLIB DD name. |        |  |

### Primary input (SYSIN)

Primary input to the prelinker consists of a sequential data set, a member of a partitioned data set, or an inline object module. The primary input must consist of one or more separately compiled object modules or prelinker control statements. (See “INCLUDE control statement” on page 583.)

If the primary input to the prelinker consists of a mix of object modules and include control statements, include control statements must be placed last (or after all object modules).

If you are prelinking an application that imports symbols from a DLL, you must include the definition side-deck for that DLL in SYSIN. The prelinker uses the definition side-deck to resolve external symbols for functions and variables that are imported by your application. If you call more than one DLL, you need to include a definition side-deck for each.

### Prelinker message file (SYSMSGs)

With this DD statement name, you provide the prelinker with the information it needs to generate error messages and the Prelinker Map.

### Prelinker and z/OS Language Environment library (STEPLIB)

To prelink your program, the system must be able to locate the data sets that contain the prelinker and z/OS Language Environment run-time library. The DD statement with the name STEPLIB points to these data sets. If the run-time library is installed in the LPA or ELPA, it is found automatically. Otherwise, SCEERUN and SCEERUN2 must be in the JOBLIB or STEPLIB. For information on the search order, see Chapter 11, “Running a C or C++ application,” on page 409.

### Secondary input (SYSLIB)

Secondary input to the prelinker consists of object modules that are not part of the primary input data set, but are to be included in the output prelinked object module from the automatic call library. The *automatic call library* contains object modules that will be used as secondary input to the prelinker to resolve external symbols left undefined after all the primary input has been processed. Concatenate multiple object module libraries by using the DD statement with the name SYSLIB. For more information on concatenating data sets, see page 301.

**Note:** SYSLIB data sets that are used as input to the prelinker must be cataloged.

### Definition side-deck (SYSDEFSD)

The prelinker generates a definition side-deck if you are prelinking an application that exports external symbols for functions and variables (a DLL). You must provide this side-deck to any user of your DLL. The users of the DLL must prelink the

side-deck of the DLL with their other object modules. The definition side-deck (SYSDEFSD) is not generated if the NODYNAM option is in effect.

### **Listing (SYSOUT)**

If you specify the MAP prelinker option, the prelinker writes a map to the SYSOUT data set. This map provides you with warnings, files that are included in input to the prelinker, and names of external symbols.

### **Output (SYSMOD)**

The prelinker produces a single prelinked object module, and stores it in the SYSMOD data set. The linkage editor uses this data set as input.

### **Prelinker error messages (SYSPRINT)**

If the prelinker encounters problems in its attempt to prelink your program, it generates error messages and places them in the SYSPRINT data set.

## **Input to the prelinker**

Input to the prelinker can be:

- One or more object modules (not previously prelinked)
- Prelinker control statements (INCLUDE, LIBRARY ...)
- Object module libraries

The process of resolving or including input from these sources depends on the type of the source and the current input and prelink options.

Unresolved references or undefined writable static objects often result if you give the prelinker input object modules produced with a mixture of inconsistent compiler options (for example, RENT | NORENT, LONGNAME | NOLONGNAME, or DLL options). These options may expose symbol names in different ways in your object file, so that the prelinker may be unable to find the matching definition of a referenced symbol if the definition and the reference are exposed differently.

### **Primary input**

Primary input to the prelinker consists of a sequential data set (file) that contains one or more separately compiled object modules, possibly with prelinker control statements. Specify the primary input data set through the SYSIN ddname.

### **Secondary input**

Secondary input to the prelinker consists of object modules that are not part of the primary input data set but are to be included as a result of processing of primary input. Object modules that are brought in because of INCLUDE control statements are secondary input. Object modules brought in as a result of automatic call library (library search) processing of currently unresolved symbols through a LIBRARY control statement or through SYSLIB are also secondary input.

An automatic call library may be in the form of:

- PDS Libraries that contain object modules
- PDSE Libraries that contain object modules
- Archive Libraries that contain object modules (if you used OMVS prelinker option)

## **Prelinker output**

Writable static references that are not resolved by the prelinker cannot be resolved later. Only the prelinker can be used to resolve writable static. The output object module of the prelinker should not be used as input to another prelink.

## Prelinker Map

When you use the MAP prelinker option, the z/OS Language Environment prelinker produces a Prelinker Map. The default is to generate a listing file. The listing contains several individual sections that are only generated if they are applicable. Unresolved references generate error or warning messages to the Prelinker Map.

## Mapping long names to short names

You can use the output object module of the prelinker as input to a system linkage editor.

Because system linkage editors accept only short names, the z/OS Language Environment prelinker maps long names to short names on output. It does not change short names. Long names can be up to 1024 characters in length. Truncation of the long names to the 8 character short name limit is therefore not sufficient because name collisions may occur.

The z/OS Language Environment prelinker maps a given long name to a short name on output according to the following hierarchy:

1. If any occurrence of the long name is a reserved run-time name, or was caused by a **#pragma map** or C **#pragma csect** directive, then that same name is chosen for all occurrences of the name. This name must not be changed, even if a RENAME control statement for the name exists. For information on the RENAME control statement, see “RENAME control statement” on page 585.
2. If the long name was found to have a matching short name, the same name is chosen. For example, D0TOTALS is coded in both a C (or C++) and an assembler program. This name must not be changed, even if a RENAME statement for the name exists. This rule binds the long name to its short name.
3. If a valid RENAME statement for the long name is present, then the short name specified on the RENAME statement is chosen.
4. If the name corresponds to a Language Environment Library function or library object for which you did not supply a replacement, the name chosen is the truncated, uppercased version of the long name library name (with `_` mapped to `@`).
5. If you specify the prelinker OMVS option and the name corresponds to a POSIX Language Environment Library function for which you did not supply a replacement, the name chosen is the internal Language Environment Library short name.

This short name is not chosen, if either:

- A valid RENAME statement renames another long name to this short name. For example, the RENAME statement `RENAME mybigname PRINTF` would make the library function `printf()` unavailable if `mybigname` is found in input.
- Another long name is found to have the same name as this short name. For example, explicitly coding and referencing `SPRINTF` in the C or C++ source program would make the library function `sprintf()` unavailable.

Avoid such practices to ensure that the appropriate Language Environment Library function is chosen.

6. If the UPCASE option is specified for a C application, names that are 8 characters or fewer are changed to uppercase, with `_` mapped to `@`. Names that begin with IBM or CEE will be changed to `IB$`, and `CE$`, respectively. Because of this rule, two different names can map to the same name. You should therefore exercise care when using the UPCASE option. The prelinker issues a warning message if it finds a collision, but it still maps the names.

7. If none of the above rules apply, a default mapping is performed. This mapping is the same as the one the compiler option NOLONGNAME uses for external names, taking collisions into account. That is, the name is truncated to 8 characters and changed to uppercase (with `_` mapped to `@`). Names that begin with IBM or CEE will be changed to IB\$ and CE\$, respectively. If this name is the same as the original name, it is always chosen. This name is also chosen if a name collision does not occur. A name collision occurs if either
- The short name has already been seen in *any* input; that is, the name is not new.
  - After applying this default mapping, the same name is generated for at least two, previously unmapped, names.

If a name collision occurs, a unique name is generated for the output name. For example, the name @ST00033 is generated.

A C application that is compiled with the NOLONGNAME compiler option and link-edited, except for collisions, presents the linkage editor with the same names as when the application is compiled with the LONGNAME option and prelinked.

See *z/OS Language Environment Debugging Guide* for a list of error messages that the prelinker returns.

---

## Linking an application

The linkage editor processes your compiled program (object module) and readies it for loading and execution. The processed object module becomes a load module which is stored in a program library or z/OS UNIX System Services file system directory and can be retrieved for execution at any time.

## Using DD statements for standard data sets—linkage editor

The linkage editor always requires four standard data sets. You must define these data sets in DD statements with the ddnames SYSLIN, SYSLMOD, SYSUT1, and SYSPRINT.

A fifth data set, defined by a DD statement with the name SYSLIB, is necessary if you want to use the automatic call library. Table 47 shows the five data set names and their characteristics.

Table 47. Data sets used for linking

| ddname              | Type    | Function  |
|---------------------|---------|---|
| SYSLIN              | Input   | Primary input data, the output of the prelinker, compiler, or assembler             |
| SYSPRINT            | Output  | Diagnostic messages<br>Informational messages<br>Module map<br>Cross-reference list |
| SYSLMOD             | Output  | Output data set for the linkage editor  |
| SYSUT1              | Utility | Temporary workspace   |
| SYSLIB <sup>1</sup> | Library | Secondary input   |
| User-specified      | Input   | Obtain additional object modules and load modules                                   |

**Notes:**

<sup>1</sup> Required for library run-time routines

## Primary input (SYSLIN)

Primary input to the linkage editor consists of a sequential data set, a member of a partitioned data set, or an inline object module. The primary input must be composed of one or more separately compiled object modules or linkage control statements. A load module cannot be part of the primary input, although the control statement INCLUDE can introduce it. (See “INCLUDE control statement” on page 583.)

## Listing (SYSPRINT)

The linkage editor generates a listing that includes reference tables that are related to the load modules that it produces. You must define the data set where you want the linkage editor to store its listing in a DD statement with the name SYSPRINT.

## Output (SYSLMOD)

Output (one or more linked load modules) from the linkage editor is always stored in a partitioned data set that is defined by the DD statement with the name SYSLMOD, unless you specify otherwise. This data set is known as a library.

## Temporary workspace (SYSUT1)

The linkage editor requires a data set for use as a temporary workspace. The data set is defined by a DD statement with the name SYSUT1. This data set must be on a direct access device.

## Secondary input (SYSLIB)

Secondary input to the linkage editor consists of object modules or load modules that are not part of the primary input data set, but are to be included in the load module from the automatic call library. The automatic call library contains load modules or object modules that are to be used as secondary input to the linkage editor to resolve external symbols that remain undefined after all the primary input has been processed.

The call library used as input to the linkage editor or loader can be a system library, a private program library, or a subroutine library.

## Input to the linkage editor

Input to the linkage editor can be:

- One or more object modules (created through the OBJECT compiler option)
- Linkage editor control statements (NAME and ALIAS) that are generated by the ALIAS compiler option
- Previously link-edited load modules that you want to combine into one load module
- z/OS Language Environment library stub routines (SYSLIB)
- Other libraries

### Primary input

Primary input to the linkage editor consists of a sequential data set that contains one or more separately compiled object modules, possibly with linkage editor control statements.

Specify the primary input data set with the SYSLIN statement. For more information on the data sets that are used with z/OS XL C/C++, refer to “Description of data sets used” on page 424.



## Secondary input

Secondary input to the linkage editor consists of object modules or load modules that are not part of the primary input data set but are to be included in the load module as the automatic call library.

The automatic call library contains object modules to be used as secondary input to the linkage editor to resolve external symbols left undefined after all primary input has been processed.

The automatic call library may be in the form of:

- Libraries that contain object modules, with or without linkage editor control statements
- Libraries that contain load modules
- The Language Environment Library, if any of the library functions are needed to resolve external references.

Secondary input is either all object modules or all load modules, but it cannot contain both types.

Specify the secondary input data sets with a SYSLIB statement and, if the data sets are object modules, add the linkage editor LIBRARY and INCLUDE control statements.

## Additional object modules as input

You can use the INCLUDE and LIBRARY linkage editor control statements to do the following:

1. Specify additional object modules that you want included in the output load module (INCLUDE statement).
2. Specify additional libraries to be searched for object modules to be included in the load module (LIBRARY statement). This statement has the effect of concatenating any specified member names with the automatic call library.

Linkage editor control statements in the primary input must specify any linkage editor processing beyond the basic processing that is described above.

## Output from the linkage editor

The output from the linkage editor can be a single load module, or multiple load modules, that are generated by using the NAME control statement of the linkage editor.

For more information on using linkage editor control statements, see *z/OS MVS Program Management: User's Guide and Reference*.

SYSLMOD and SYSPRINT are the data sets that are used for link-edit output. The output from the linkage editor varies, depending on the options you select, as shown in Table 48.

Table 48. Options for controlling link-edit output

| To Get This Output   | Use This Option |
|--|-----------------|
| A map of the load modules generated by the linkage editor. | MAP             |
| A cross-reference list of data variables                   | XREF            |
| Informational messages                                     | Default         |



Table 48. Options for controlling link-edit output (continued)

| To Get This Output  | Use This Option |
|---|-----------------|
| Diagnostic messages   | Default         |
| Listing of the linkage editor control statements              | LIST            |
| One or more load modules (which you must assign to a library) | Default         |

By default, you receive diagnostic and informative messages as the result of link-editing. You can get the other output items by specifying options in the PARM parameter in the EXEC statement in your link-edit JCL.

The load modules that are created are written in the data set that is defined by the SYSLMOD DD statement in your link-edit JCL. All diagnostic output to be listed is written in the data set that is defined by the SYSPRINT DD statement.

### Detecting link-edit errors

You receive a listing of diagnostic messages in SYSPRINT. Check the linkage editor map to make sure that all the object and load modules you expected were included.

You can find a description of link-edit messages in *z/OS MVS Program Management: User's Guide and Reference*.

The instructions for link-edit processing vary, depending on whether you are running under z/OS batch or TSO.

**Note:** For information on link-editing modules for interlanguage calls, refer to *z/OS Language Environment Programming Guide*.

### Library routine considerations

The Language Environment Library consists of one run-time component that contains all Language Environment-enabled languages, such as C, C++, COBOL, and PL/I. For detailed instructions on linking and running z/OS XL C/C++ programs under z/OS Language Environment, refer to *z/OS Language Environment Programming Guide*.

The Language Environment Library is *dynamic*. This means that many of the functions, such as library functions, available in z/OS XL C/C++ are not physically stored as a part of your executable program. Instead, only a small portion of code is stored with your executable program, resulting in a smaller executable module size. This portion of code is known as a stub routine. The stub routine represents each required library function. Each of these stub routines has:

- The same name as the library function which it represents.
- Enough code to locate the true library function at run time.

The C stub routines are in the file CEE.SCEELKED, which is part of z/OS Language Environment and must be specified as one of the libraries to be searched during autocall.

## Link-editing multiple object modules

z/OS XL C generates a CEESTART CSECT at the beginning of the object module for any source program that contains the function `main()` (and for which the START compiler option was specified) or a function for which a **#pragma linkage (name, FETCHABLE)** preprocessor directive applies. When multiple object modules are link-edited into a single load module, the entry point of the resulting load module is

resolved to the external symbol CEESTART. Run-time errors occur if the load module entry point is forced to some other symbol by use of the linkage editor ENTRY control statement.

If a C main() function is link-edited with object modules produced by C, other language processors or by assembler, the module containing the C main() must be the first module to receive control. You must also ensure that the entry point of the resulting load module is resolved to the external symbol CEESTART. To ensure this, the input to the linkage editor can include the following linkage editor ENTRY control statement:

```
ENTRY CEESTART
```

If you are building a DLL, you may need to use the ENTRY control statement as described above.

---

## Building DLLs

**Note:** This section does not describe all of the steps that are required to build a DLL. It only describes the prelink step. For a complete description of how to build DLLs, see *z/OS XL C/C++ Programming Guide*.

Except for the object modules you require for creating the DLL, you do not require additional object modules. The prelinker automatically creates a definition side-deck that describes the functions and the variables that DLL applications can import.

**Note:** Although some C applications may need only the linkage editor to link them, all DLLs require either the use of the binder with the DYNAM(DLL) option, or the prelinker before the linkage editor.

When you build a DLL, the prelinker creates a definition side-deck, and associates it with the SYSDEFSD ddname. You must provide the generated definition side-deck to all users of the DLL. Any DLL application which implicitly loads the DLL must include the definition side-deck when they prelink.

**Example:** The following is an example of a definition side-deck generated by the prelinker when prelinking a C object module:

```
IMPORT CODE 'BASICIO'   bopen
IMPORT DATA 'BASICIO'  bclose
IMPORT DATA 'BASICIO'  bread
IMPORT DATA 'BASICIO'  bwrite
IMPORT DATA 'BASICIO'  berror
```

You can edit the definition side-deck to remove any functions or variables that you do not want to export. For instance, in the above example, if you do not want to expose function berror, remove the control statement IMPORT DATA 'BASICIO' berror from the definition side-deck.

**Note:** You should also provide a header file that contains the prototypes for exported functions and external variable declarations for exported variables.

**Example:** The following is an example of a definition side-deck generated by the prelinker when prelinking a C++ object module:

```
IMPORT CODE 'TRIANGLE' getarea__8triangleFv
IMPORT CODE 'TRIANGLE' getperim__8triangleFv
IMPORT CODE 'TRIANGLE' __ct__8triangleFv
```

You can edit the definition side-deck to remove any functions and variables that you do not want to export. For instance, in the above example, if you do not want to expose `getperim()`, remove the control statement `IMPORT CODE 'TRIANGLE' getperim__8triangleFv` from the definition side-deck.

The definition side-deck contains mangled names, such as `getarea__8triangleFv`. If you want to know what the original function or variable name was in your source module, look at the compiler listing created. Alternatively, use the `CXXFILT` utility to see both the mangled and demangled names. For more information on the `CXXFILT` utility, see Chapter 14, “Filter utility,” on page 449.

**Note:** You should also provide users of your DLL with a header file that contains the prototypes for exported functions and extern variable declarations for exported variables.

The prelinker `NODYNAM` option must not be in effect when building DLLs.

## Linking your code

When you link your code, ensure that you specify the `RENT` or `REUS(SERIAL)` options.

---

## Using DLLs

The prelinker is used to build DLLs that export defined external functions and variables, and to build programs or DLLs that import external functions and variables from other DLLs.

**Note:** The prelinker `NODYNAM` option must not be in effect when using or building DLLs.

To assign a name to a DLL, use either the `DLLNAME()` prelinker option, or the `NAME` control statement. If you do not assign a name, and the data set `SYSMOD` is a PDS member, the member name is used as the DLL name. Otherwise, the name `TEMPNAME` is used.

To build a DLL, you need to compile object code that exports external functions or variables, then prelink and link that code into a load module. During the prelink step you need to capture the definition side-deck which is written to the ddname `SYSDEFSD`. The definition side-deck is a list of `IMPORT` control statements that correspond to the external functions and variables exported by the DLL.

Include the `IMPORT` statements at prelink time for any program that imports variables or functions from the DLL.

**Example:** In the following C example, `EXPONLY` is a DLL which only exports a single variable `year`:

```
/* EXPONLY.C */
int year = 2001;      /* exported from this DLL */
```

**Example:** In the following example, IMPEXP is a DLL that both imports and exports external functions and variables. It imports the external variable year from DLL EXPONLY, and exports external functions next\_year and get\_year.

```
/* IMPEXP.C */
extern int year;          /* imported from DLL EXPONLY */

void next_year(void) { /* exported from this DLL */
    ++year;           /* load DLL EXPONLY, modify 'year' in DLL */
}

int get_year(void) { /* exported from this DLL */
    return year;     /* get value of 'year' from DLL EXPONLY */
}
```

**Example:** In the following example, IMPONLY is a program that only imports functions and variables. It imports the variable year from DLL EXPONLY, and it imports functions next\_year and get\_year from DLL IMPEXP.

```
/* IMPONLY.C */
#include <stdio.h>
extern int get_year(void); /* import from DLL IMPEXP */
extern void next_year(void); /* import from DLL IMPEXP */
extern int year;          /* import from DLL EXPONLY */
int main(void)
{
    int y;
    next_year();          /* load DLL IMPEXP, call function from DLL */
    y = get_year();      /* call function in DLL IMPEXP */
    if ( y == 2002
        && year == 2002) /* get value of 'year' from DLL EXPONLY */
        printf("pass\n");
    else
        printf("fail\n");
    return 0;
}
```

**Example:** The following JCL builds the DLLs EXPONLY, IMPEXP, and the program IMPONLY, and then runs IMPONLY:

```

/* -----
//CEXPONLY EXEC EDCC,
// INFILE='USERID.DLL.C(EXPONLY)',
// OUTFILE='USERID.DLL.OBJECT(EXPONLY),DISP=SHR ',
// CPARM='LONG RENT EXPORTALL'
/* -----
//CIMPEXP EXEC EDCC,
// INFILE='USERID.DLL.C(IMPEXP)',
// OUTFILE='USERID.DLL.OBJECT(IMPEXP),DISP=SHR ',
// CPARM='LONG RENT DLL EXPORTALL'
/* -----
//CIMPONLY EXEC EDCC,
// INFILE='USERID.DLL.C(IMPONLY)',
// OUTFILE='USERID.DLL.OBJECT(IMPONLY),DISP=SHR ',
// CPARM='LONG RENT DLL'
/* -----
//LINK1 EXEC CBCL,PPARM='DLLNAME(EXPONLY)',
// OUTFILE='USERID.DLL.LOAD(EXPONLY),DISP=SHR '
//PLKED.SYSIN DD DSN=USERID.DLL.OBJECT(EXPONLY),DISP=SHR
//PLKED.SYSDEFSD DD DSN=USERID.DLL.IMPORTS(EXPONLY),DISP=SHR
/* -----
//LINK2 EXEC CBCL,PPARM='DLLNAME(IMPEXP)',
// OUTFILE='USERID.DLL.LOAD(IMPEXP),DISP=SHR '
//PLKED.SYSIN DD DSN=USERID.DLL.OBJECT(IMPEXP),DISP=SHR
// DD DSN=USERID.DLL.IMPORTS(EXPONLY),DISP=SHR
//PLKED.SYSDEFSD DD DSN=USERID.DLL.IMPORTS(IMPEXP),DISP=SHR

```

Figure 48. JCL to build DLLs (Part 1 of 2)

```

/* -----
//LINK3 EXEC CBCL,
// OUTFILE='USERID.DLL.LOAD(IMPONLY),DISP=SHR '
//PLKED.SYSIN DD DSN=USERID.DLL.OBJECT(IMPONLY),DISP=SHR
// DD DSN=USERID.DLL.IMPORTS(EXPONLY),DISP=SHR
// DD DSN=USERID.DLL.IMPORTS(IMPEXP),DISP=SHR
/* -----
//GO EXEC PGM=IMPONLY
//STEPLIB DD DSN=USERID.DLL.LOAD,DISP=SHR
// DD DSN=CEE.SCEERUN,DISP=SHR
// DD DSN=CEE.SCEERUN2,DISP=SHR
//SYSOUT DD SYSOUT=*
//SYSPRINT DD SYSOUT=*

```

Figure 48. JCL to build DLLs (Part 2 of 2)

- Both EXPONLY and IMPEXP are compiled with the option EXPORTALL because they export external functions and variables.
- Both IMPEXP and IMPONLY are compiled with the option DLL because they import functions and variables from other DLLs.
- Step LINK1 generates a definition side-deck USERID.DLL.IMPORTS(EXPONLY) which is a list of external functions and variables that are exported by DLL EXPONLY.
- Step LINK2 uses the definition side-deck that is generated in step LINK1 as part of the prelinker input to import the variable year from DLL EXPONLY.
- Step LINK2 generates a definition side-deck USERID.DLL.IMPORTS(IMPEXP) that is a list of external functions and variables that are exported by DLL IMPEXP.
- Both steps LINK1 and LINK2 use the prelinker DLLNAME option to set the DLL name seen on IMPORT statements generated in the definition side-decks.
- Step LINK3 uses the definition side-decks generated in step LINK1 and LINK2 as part of the prelinker input to import the variable year from DLL EXPONLY and to import the functions get\_year and set\_year from DLL IMPEXP.

- Step LINK3 does not specify a definition side-deck; program IMPONLY does not export any functions or variables.
- If you explicitly specify link-time parameters, be sure to specify the RENT option. The IBM-supplied cataloged procedure CBCL does this by default.
- The load module name of a DLL must match the DLLNAME seen on the corresponding IMPORT statements.
- Step GO has the program IMPONLY and the DLLs. EXPONLY and IMPEXP in its STEPLIB concatenation so that the DLLs can be dynamically loaded at run time.

To see which functions and variables are imported or exported use the Prelinker Map. The following is a portion of the Prelinker Map from step LINK2:

```

=====
|                               Load Module Map 1                               |
=====

MODULE ID  MODULE NAME

    00001   EXPONLY

=====
|                               Import Symbol Map 2                               |
=====

*TYPE      FILE ID  MODULE ID  NAME
    D       00001   00001     year
*TYPE:  D=imported data  C=imported code

=====
|                               Export Symbol Map 3                               |
=====

*TYPE      FILE ID  NAME
    C       00001   get_year
    C       00001   next_year
*TYPE:  D=exported data  C=exported code

```

### 1 Load Module Map

This section lists the load modules from which functions and variables are imported. The load module names come from the input IMPORT control statements processed.

### 2 Import Symbol Map

This section lists the imported functions and variables. The MODULE ID indicates the DLL from which the function or variable is imported. The FILE ID indicates the file in which the IMPORT control statement was processed that resulted in this import.

### 3 Export Symbol Map

This section lists the external functions and variables which are exported. For each symbol that is listed in this section, an IMPORT control statement is written out to the DDname SYSDEFSD, the definition side-deck.

**Note:** The export symbol map will not be produced when the NODYNAM option is in effect.

## Prelinking and linking an application under z/OS batch and TSO

Figure 49 shows the basic prelinking and linking process for your C or C++ application.

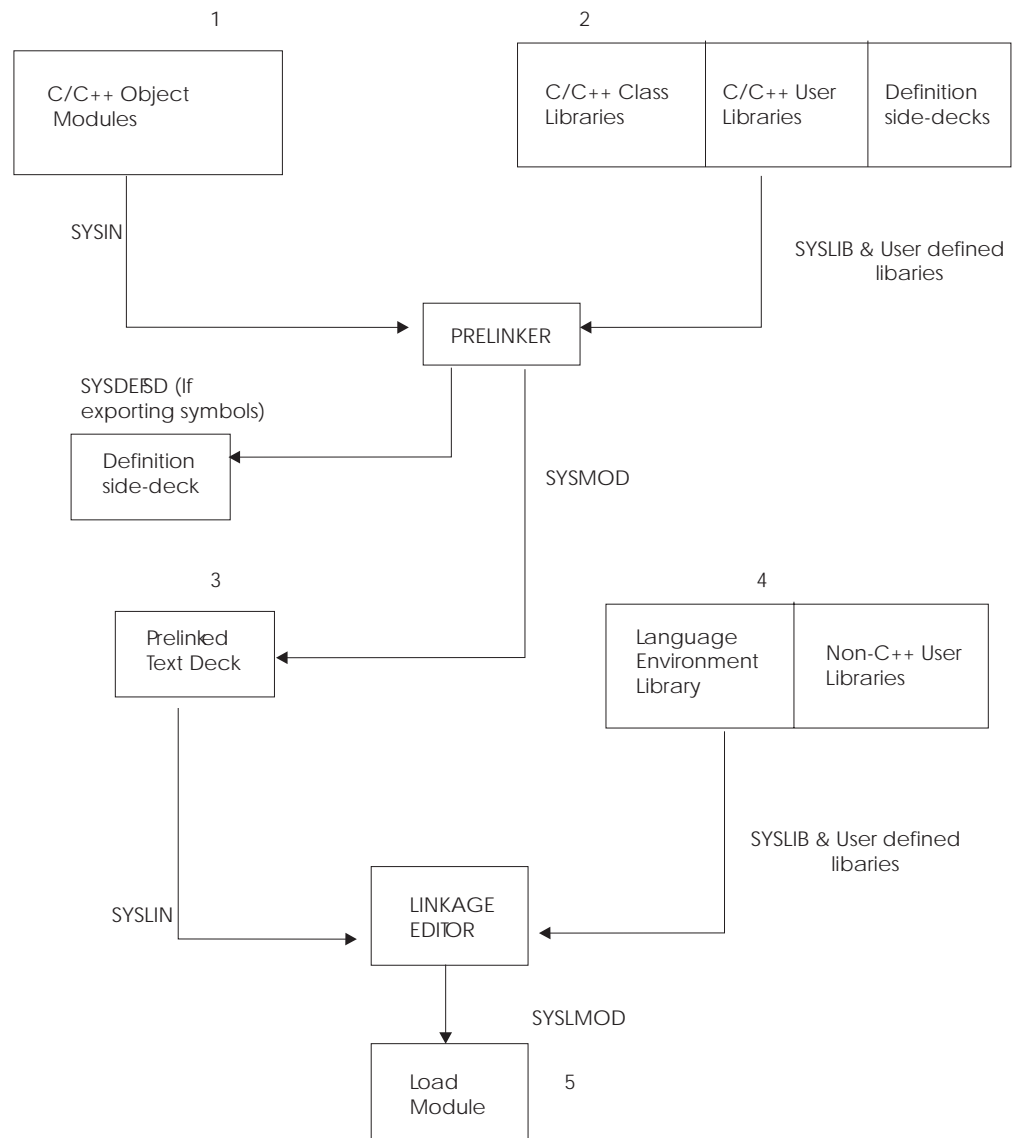

Figure 49. Basic prelinker and linkage editor processing

The data set SYSIN, **1**, that contains your object modules forms the primary input of the prelinker.

**Note:** If you are creating an application that imports symbols from DLLs, you must provide the definition side-deck for each DLL referenced in SYSIN.

The prelinker uses its primary input, and its secondary input, **2**, from SYSLIB to produce a prelinked object module and, if you are exporting symbols, a definition side-deck. SYSLIB points to PDS libraries or PDSE libraries which may contain the following:

- Object modules with long names
- Object modules with writable static references

- C/C++ object module libraries
- DLL definition side-decks

The prelinked output object module is put in SYSMOD. If a definition side-deck is generated, it is put in SYSDEFSD, which is a sequential data set or a PDS member.

The linkage editor takes its primary input from SYSLIN which refers to the prelinked object module data set, **3**. The linkage editor uses the primary input and secondary input, **4**, to produce a load module, **5**. The secondary input consists of non-C++ user defined libraries, and the z/OS Language Environment run-time library (SCEELKED) specified using SYSLIB.

The load module, **5**, is put in the SYSLMOD data set. The load module becomes a permanent member of SYSLMOD. You can retrieve it at any time to run in the job that created it, or in any other job.

---

## z/OS Language Environment Prelinker Map

When you use the MAP prelinker option, the z/OS Language Environment prelinker produces a Prelinker Map. The listing contains several individual sections that are only generated if they are applicable.

**Example:** Consider the following example. The data set USERID.DLL.SOURCE(EXPONLY) contains

```
/* EXPONLY.C */
   int year = 2001; /* exported from this DLL */
```

After step LINK0 in Figure 51 on page 565, the definition side-deck USERID.DLL.IMPORTS(EXPONLY) contains the record IMPORT DATA 'EXPONLY' year.

The map that is shown in Figure 52 on page 565 was created by compiling the program that is shown in Figure 50. Figure 52 on page 565 is the corresponding Prelinker Map from step LINK1. The linkage editor places the resulting load module in USERID.DLL.LOAD(IMPEXP2).

```
/* IMPEXP2.C */
#pragma variable(this_int_not_in_writable_static, NORENT)
int this_int_not_in_writable_static = 2001;
extern int year;
int this_int_is_in_writable_static = 1900;
int get_year(void) {
    return year;
}
void next_year(void) {
    year++;
}
void Name_Collision_In_First8(void) {
}
void Name_Collision_In_First_Eight(void) {
}
```

*Figure 50. z/OS XL C++ source file used for the example Prelinker Map*



```

/*
//COMP0 EXEC CBCC,CPARM='EXPORTALL',
// INFILE='USERID.DLL.SOURCE(EXPONLY)',
// OUTFILE='USERID.DLL.OBJECT(EXPONLY),DISP=SHR'
//LINK0 EXEC CBCL,PPARM='DLLNAME(EXPONLY) NONCAL MAP',
// OUTFILE='USERID.DLL.LOAD(EXPONLY),DISP=SHR'
//PLKED.SYSIN DD DSN=USERID.DLL.OBJECT(EXPONLY),DISP=SHR
//PLKED.SYSDEFSD DD DSN=USERID.DLL.DEFSD(EXPONLY),DISP=SHR
/*
//COMP1 EXEC CBCC,CPARM='EXPORTALL',
// INFILE='USERID.DLL.SOURCE(IMPEXP2)',
// OUTFILE='USERID.DLL.OBJECT(IMPEXP2),DISP=SHR'
//LINK1 EXEC CBCL,PPARM='DLLNAME(IMPEXP2) NONCAL MAP',
// OUTFILE='USERID.DLL.LOAD(IMPEXP2),DISP=SHR'
//PLKED.SYSIN DD DSN=USERID.DLL.OBJECT(IMPEXP2),DISP=SHR
// DD DSN=USERID.DLL.DEFSD(EXPONLY),DISP=SHR
//PLKED.SYSDEFSD DD DSN=USERID.DLL.DEFSD(IMPEXP2),DISP=SHR

```

Figure 51. Example of JCL used to generate the example Prelinker Map for a C++ program.

```

=====
|                               Prelinker Map 1                               |
| CPLINK:5645001 V1 R8 M00 IBM Language Environment 2006/02/23 01:32:51 |
=====

Command Options. . . . . : NONCAL  NOMEMORY ER      DUP      MAP
                        : NOOMVS  NOUPCASE  DYNAM

=====
|                               Object Resolution Warnings 2                               |
=====

WARNING EDC4015: Unresolved references are detected:
CEESTART CEESG003 @@TRGLOR

```

Figure 52. Prelinker Map (Part 1 of 3)

```
=====
|                                     File Map 3                                     |
=====
```

```
*ORIGIN  FILE ID  FILE NAME
```

```
  P      00001  DD:SYSIN
  A      00002  CEE210.SCEECPP(EDCHSG03)
  IN     00003  *** DESCRIPTORS ***
```

```
*ORIGIN:  P=primary input      PI=primary INCLUDE    SI=secondary INCLUDE
           A=automatic call     R=RENAME card      L=C Library
           IN=internal
```

```
=====
|                                     Writable Static Map 4                                     |
=====
```

```
  OFFSET    LENGTH  FILE ID  INPUT NAME
```

```
      0         4   00001  this_int_is_in_writable_static
      8        10   00003  <year>
     18         4   00001  @STATIC
```

```
=====
|                                     Load Module Map 5                                     |
=====
```

```
MODULE ID  MODULE NAME
```

```
  00001    EXPONLY
```

```
=====
|                                     Import Symbol Map 6                                     |
=====
```

```
*TYPE     FILE ID  MODULE ID  NAME
```

```
  D      00001    00001  year
```

```
*TYPE:  D=imported data  C=imported code
```

Figure 52. Prelinker Map (Part 2 of 3)

```

=====
|                               Export Symbol Map 7                               |
=====

```

```

*TYPE    FILE ID  NAME
C        00001   get_year()
C        00001   next_year()
D        00001   this_int_is_in_writable_static
C        00001   Name_Collision_In_First_Eight()
C        00001   Name_Collision_In_First8()

```

\*TYPE: D=exported data C=exported code

```

=====
|                               ESD Map of Defined and Long Names 8                               |
=====

```

```

          OUTPUT
*REASON  FILE ID  ESD NAME  INPUT NAME
P                CEESTART  CEESTART
D        00001   THIS@INT  this_int_not_in_writable_static
D        00001   GET@YEAR  get_year()
D        00001   NEXT@YEA  next_year()
D        00001   @ST00003  Name_Collision_In_First8()
D        00001   @ST00002  Name_Collision_In_First_Eight()
P                CEESG003  CEESG003
P        00002   CBCSG003  CBCSG003
P                @@TRGLOR  @@TRGLOR

```

\*REASON: P=#pragma or reserved    S=matches short name    R=RENAME card  
          L=C Library                U=UPCASE option        D=Default

```

=====  E N D   O F   P R E - L I N K A G E   M A P   =====

```

Figure 52. Prelinker Map (Part 3 of 3)

The numbers in the following text correspond to the numbers that are shown in the map.

### 1 Heading

The heading is always generated. It contains the product number, the library release number, the library version number, and the date and the time the prelink step began. A list of the prelinker options that are in effect for the step follow.

### 2 Object Resolution Warnings

This section is generated if objects remained undefined at the end of the prelink step, or the IPA Link step, or if duplicate objects were detected during the step. The names of the applicable objects are listed.

### 3 File Map

This section lists the object modules that were included in input. An object module consisting only of RENAME control statements, for example, is *not* shown. Also provided in this section are source origin (FILE NAME), and identifier (FILE ID) information. The object module came from primary input because of:

- An INCLUDE control statement in primary or secondary input
- A RENAME control statement
- The resolution of long name library references
- The object module was internal and self-generated by the prelink step

The FILE ID may appear in other sections, and is used as a cross reference to the object module. The FILE NAME can be one of:

- The data set name and, if applicable, the member name
- The ddname and, if applicable, the member name
- The z/OS UNIX System Services file name

If you are prelinking an application that imports variables or functions from a DLL, the variable descriptors and function descriptors are defined in a file called `*** DESCRIPTORS ***`. This file has an origin of internal.

#### **4 Writable Static Map**

This section is generated if an object module was encountered that contains defined static external data. This area also contains variable descriptors for any imported variables and, if required, function descriptors. This section lists the names of such objects, their lengths, their relative offset within the writable static area, and a FILE ID for the file containing the definition of the object.

#### **5 Load Module Map**

This section is generated if the application imports symbols from other load modules. This section lists the names of the load modules.

#### **6 Import Symbol Map**

This section is generated if symbols are imported from other load modules. These otherwise unresolved DLL references are resolved through IMPORT control statements. This section lists those symbols. It describes the type of symbol; that is, D (variable) or C (function). It also lists the file id of the object module containing the corresponding IMPORT control statements, the module id of the load module on that control statement, and the symbol name.

A DLL application would generate this section.

#### **7 Export Symbol Map**

This section is generated if an object module is encountered that exports symbols. This section lists those symbols. It describes the type of symbol; that is, D (variable) or C (function). It also lists the file id of the object where the symbol is defined and the symbol name. Only externally defined data objects in writable static or externally defined functions can be exported.

Code that is compiled with the EXPORTALL compiler option or code that contains the `#pragma export` directive would generate an object module that exports symbols.

**Note:** The export symbol map will not be produced if the NODYNAM option is in effect.

#### **8 ESD Map of Defined and Long Names**

This section lists the names of external symbols that are not in writable static. It also shows a mapping of input long names to output short names.

If the object is defined, the FILE ID indicates the file that contains the definition. Otherwise, this field is left blank. For any name, the input name and output short name are listed. If the input name is indeed an long name, the rule that is used to map the long name to the short name is applied. If the name is not an long name, this field is left blank.

**Note:** Although mangled names exist in the object modules, the Prelinker Map and messages emit the demangled equivalent, which is like the names seen in the C++ source code.

## Processing the prelinker automatic library call

The following hierarchy is used to resolve a referenced and currently undefined symbol.

- The undefined name is an short name, for example SNAME.
  - If the NONCAL command option is in effect, the partitioned data sets that are concatenated to SYSLIB are searched in order as follows:
    - If the data set contains a C370LIB-directory created using the z/OS XL C/C++ object library utility, and the C370LIB-directory shows that a defined symbol by that name exists, the member of the PDS containing that symbol is read.
    - If the data set does not contain a C370LIB-directory created using the z/OS XL C/C++ object library utility and the reference is not to static external data, the member or alias, with the same name as SNAME is read.
- The undefined name is an long name.
  - If the NONCAL command option is in effect, the partitioned data sets that are concatenated to SYSLIB are searched. If the data set contains a C370LIB-directory created using the z/OS XL C/C++ object library utility, and the C370LIB-directory shows that a defined symbol by that name exists, the member of the PDS indicated as containing that symbol is read.

For more information about the z/OS XL C/C++ object library utility, see Chapter 13, “Object library utility,” on page 437.

## References to currently undefined symbols (external references)

If the symbol is undefined after the prelink step, and is not a writable static symbol, it may be subsequently defined during the link step. However, the definition must be exactly the same as the output ESD name. For more information, see the Figure 52 on page 565.

If you are writing a C application, and the symbol is an long name that was not resolved by automatic library call and for which a RENAME statement with the SEARCH option exists, the symbol is resolved under the short name on the RENAME statement by automatic library call.

See “RENAME control statement” on page 585 for a complete description of the RENAME control statement.

Unresolved requests generate error or warning messages to the Prelinker Map.

## Prelinking and linking under z/OS batch

### Using IBM-supplied cataloged procedures

The IBM-supplied catalog procedures and REXX EXECs use the DLL versions of the IBM-supplied class libraries by default. That is, the IBM-supplied Class Libraries definition side-deck data set, SCLBSID, is included in the SYSIN concatenation.

If you are *statically* linking the relevant class library object code, you must override the PLKED.SYSLIB concatenation to include the SCLBCPP or SCLBCPP2 data set. The z/OS V1R2 version of the static library is in CBC.SCLBCPP2.

**Note:** If your application consists of multiple modules (for example, a main module and a DLL) that use the same class library, make sure that all your modules link dynamically to the class library. Otherwise, the class library will be linked

in multiple times, and there will be multiple copies in use by your application. You cannot use multiple copies of a class library within a single application. If you do, you can have unexpected results.

You can use one of the following IBM-supplied cataloged procedures that include a link-edit step to link-edit your z/OS XL C program:

**EDCCL**

Compile and link-edit

**EDCCLG**

Compile, link-edit, and run

**EDCCPL**

Compile, prelink, and link-edit

**EDCCPLG**

Compile, prelink, link-edit, and run

**Note:** By default, the procedures EDCCL, EDCCLG, and EDCCPLG do not save the compiled object. EDCCLG and EDCCPLG do not save load modules. See Chapter 12, “Cataloged procedures and REXX EXECs,” on page 419 for more information on REXX EXECs and their uses.

**Example:** The following example shows the general job control procedure for link-editing a program under z/OS batch using the Language Environment Library.

```
// jobcard
// *
// * THE FOLLOWING STEP LINKS THE MEMBERS TESTFILE AND DECODE FROM
// * THE LIBRARIES USERID.WORK.OBJECT AND USERID.LIBRARY.OBJECT AND
// * PLACES THE LOAD MODULE IN USERID.WORK.LOAD(TEST)
// *
//LKED EXEC PGM=IEWL,REGION=1024K,PARM='AMODE=31,RMODE=ANY,MAP'
//SYSLIB DD DSNAME=CEE.SCEELKED,DISP=SHR
//SYSLIN DD DDNAME=SYSIN
//SYSMOD DD DSNAME=USERID.WORK.LOAD(TEST),DISP=SHR
//OBJECT DD DSNAME=USERID.WORK.OBJECT,DISP=SHR
//LIBRARY DD DSNAME=USERID.LIBRARY.OBJECT,DISP=SHR
//SYSPRINT DD SYSOUT=*
//SYSUT1 DD UNIT=VIO,SPACE=(32000,(30,30))
//SYSIN DD DATA,DLM=@@
        INCLUDE OBJECT(TESTFILE)
        INCLUDE LIBRARY(DECODE)
@@
```

Figure 53. Link-editing a program under z/OS batch

You can use one of the following IBM-supplied cataloged procedures that include a prelink and link step to link your C++ program:

**CBCCL**

Compile, prelink, and link

**CBCL** Prelink and link

**CBCCLG**

Compile, prelink, link, and run

**CBCLG**

Prelink, link, and run.

### Specifying prelinker and link-edit options using cataloged procedures

In the cataloged procedures use the PPARM statement to specify prelinker options and the LPARM statement to specify link-edit options as follows:

```
PPARM="prelinker-options"
LPARM="link-edit-options"
```

where *prelinker-options* is a list of prelinker options and *link-edit-options* is a list of link-edit options. Separate link-edit options and prelinker options with commas.

## Writing JCL for the prelinker and linkage editor

You can use cataloged procedures rather than supply all of the job control language (JCL) required for a job step that invokes the prelinker or linkage editor. However, you should be familiar with these JCL statements. This familiarity enables you to make the best use of the prelinker and linkage editor and, if necessary, override the statements of the cataloged procedure.

For a description of the IBM-supplied cataloged procedures that include a prelink and link step, see Chapter 12, “Cataloged procedures and REXX EXECs,” on page 419.

The following sections describe the basic JCL statements for prelinking and linking.

### Using the EXEC statement

Use the EXEC job control statement in your JCL to invoke the prelinker. The following example shows an EXEC statement that invokes the prelinker:

```
//PLKED EXEC PGM=EDCPRLK
```

You can also use the EXEC job control statement in your JCL to invoke the linkage editor. The following is a sample EXEC statement that invokes the linkage editor:

```
//LKED EXEC PGM=HEWL
```

**Note:** If you are using DLLs, you must use the RENT linkage editor option.

### Using the PARM parameter

By using the PARM parameter of the EXEC statement, you can select one or more of the optional facilities that the prelinker and linkage editor provide.

For example, if you want the prelinker to use the automatic call library to resolve unresolved references, specify the NONCAL prelinker option using the PARM parameter on the prelinker EXEC statement:

```
//PLKED EXEC PGM=EDCPRLK,PARM='NONCAL'
```

If you want a mapping of the load modules produced by the linkage editor, specify the MAP option with the PARM parameter on the linkage editor EXEC statement:

```
//LKED EXEC PGM=HEWL,PARM='MAP'
```

For a description of prelinker options see “Prelinker options” on page 591, for linkage editor options see “Linkage editor options” on page 593.

### Example of JCL to prelink and link

Figure 54 on page 572 shows a typical sequence of job control statements to link-edit an object module into a load module.

```

/*-----
/* PRE-LINKEDIT STEP:
/*-----
//PLKED EXEC PGM=EDCPRLK,REGION=2048K,PARM='MAP'
//STEPLIB DD DSN=CEE.SCEERUN,DISP=SHR
// DD DSN=CEE.SCEERUN2,DISP=SHR
//SYMSGS DD DSN=CEE.SCEEMSGP(EDCPMSGE),DISP=SHR
//SYSLIB DD DSN=CEE.SCEECPP,DISP=SHR
// DD DSN=CBC.SCLBCPP,DISP=SHR
//SYSIN DD DSN=USERID.TEXT(PROG1),DISP=SHR
//SYSMOD DD DSN=&&PLKSET,UNIT=VIO,DISP=(MOD,PASS),
// SPACE=(32000,(30,30)),
// DCB=(RECFM=FB,LRECL=80,BLKSIZE=32000)
//SYSDEFS DD DSN=USERID.TEXT(PROG1IMP),DISP=SHR
//SYSOUT DD SYSOUT=*
//SYSPRINT DD SYSOUT=*
/*-----
/* LINKEDIT STEP:
/*-----
//LKED EXEC PGM=HEWL,REGION=1024K,COND=(8,LE,PLKED),PARM='MAP'
//SYSLIB DD DSN=CEE.SCEELKED,DISP=SHR
//SYSLIN DD DSN=*.PLKED.SYSMOD,DISP=(OLD,DELETE)
//SYSLOAD DD DSN=USERID.LOAD(PROG1),DISP=SHR
//SYSUT1 DD UNIT=VIO,SPACE=(32000,(30,30))
//SYSPRINT DD SYSOUT=*

```

Figure 54. Creating a load module under z/OS batch

**Note:** For a C++ application, this JCL uses static class libraries.

## Specifying link-edit options through JCL

In your JCL for link-edit processing, use the PARM statement to specify link-edit options:

```

PARM=(link-edit-options)
PARM.STEPNAME=('link-edit-options') (If a PROC is used)

```

where *link-edit-options* is a list of link-edit options. Separate the link-edit options with commas.

You can prelink and link C/C++ applications under z/OS batch by submitting your own JCL to the operating system or by using the IBM cataloged procedures. See Chapter 12, “Cataloged procedures and REXX EXECs,” on page 419 for more information on the supplied procedures.

## Secondary input to the linker

Secondary input is either all object modules or all load modules, but it cannot contain both types.

Specify the secondary input data sets with a SYSLIB statement and, if the data sets are object modules, add the linkage editor LIBRARY and INCLUDE control statements. If you have multiple secondary input data sets, concatenate them as follows:

```

//SYSLIB DD DSNAME=CEE.SCEELKED,DISP=SHR
// DD DSNAME=AREA.SALESLIB,DISP=SHR

```

To specify additional object modules or libraries, code INCLUDE and LIBRARY statements after your DD statements as part of your job control procedure, such as in Figure 55 on page 573.



```

:
//SYSLIN DD    DSNAME=&&GOFILE,DISP=(SHR,DELETE)
//          DD    *
          INCLUDE ddname(member)
          LIBRARY ADDLIB(CPGM10)
/*

```

Figure 55. Linkage editor control statements

When the linkage editor encounters the INCLUDE statement, it incorporates the data sets that the control statement specifies. In contrast, the linkage editor uses the data sets that are specified by the LIBRARY statement only when there are unresolved references after it.

When you use cataloged procedures or your own JCL to invoke the linkage editor, external symbol resolution by automatic library call involves a search of the data set defined by the DD statement with the name SYSLIB.

## Using additional input object modules under z/OS batch

When you use cataloged procedures or your own JCL to invoke the prelinker and linkage editor, external symbol resolution by automatic library call involves a search of the SYSLIB data set. The prelinker and linkage editor locate the functions in which the external symbols are defined (if such functions exist), and include them in the output module.

You can use prelinker and linkage control statements INCLUDE and LIBRARY to do the following:

1. Specify additional object modules that you want included in the output module (INCLUDE statement).
2. Specify additional libraries to be searched for modules to be included in the output module (LIBRARY statement). This statement has the effect of concatenating any specified member names with the automatic call library.

**Example:** Code these statements after your DD statements as part of your job control procedure; for example:

```

:
//SYSIN DD    DSNAME=&&GOFILE,DISP=(SHR,DELETE)
//          DD    *
          INCLUDE ddname(member)
          LIBRARY ADDLIB(CPGM10)
/*

```

Data sets specified by the INCLUDE statement are incorporated as the prelinker and linkage editor encounter the statement. In contrast, data sets specified by the LIBRARY statement are used only when there are unresolved references after all the other input is processed.

Any prelinker and linkage editor processing beyond the basic processing described above must be specified by linkage editor control statements in the primary input.

## Under TSO

The z/OS Language Environment prelinker is started under TSO through REXX EXECs. The IBM supplied REXX EXECs that invoke the prelinker and create an executable module are called CXXMOD and CPLINK. If you want to create a reentrant load module, you must use these REXX EXECs instead of the TSO LINK command. It is recommended that you use CXXMOD instead of CPLINK. For a

description of the CXXMOD REXX EXEC see “Prelinking and linking under TSO.” For a description of the CPLINK command see “Other z/OS XL C utilities” on page 431.

When using the TSO LINK command processor, the data set defined by the LIB operand will be used by the command processor for external symbol resolution. The linkage editor locates the functions in which the external symbols are defined (if such functions exist), and includes them in the load module.

Any linkage editor processing beyond the basic processing described above must be specified by linkage editor control statements in the primary input. The IBM-supplied catalog procedures and REXX EXECs use the DLL versions of the IBM-supplied class libraries by default.

To link-edit your z/OS XL C program under TSO, use either the CXXMOD, CMOD, or the LINK command. It is recommended that you use CXXMOD, particularly when linking z/OS XL C and z/OS XL C++ object decks. For a description of the CXXMOD REXX EXEC see “Prelinking and linking under TSO.” For a description of CMOD and the TSO LINK command see “Other z/OS XL C utilities” on page 431.

### Prelinking and linking under TSO

This section describes how to prelink and link your z/OS XL C++ or z/OS XL C program by invoking the CXXMOD REXX EXEC. This REXX EXEC creates an executable module.

The syntax for the CXXMOD REXX EXEC is:

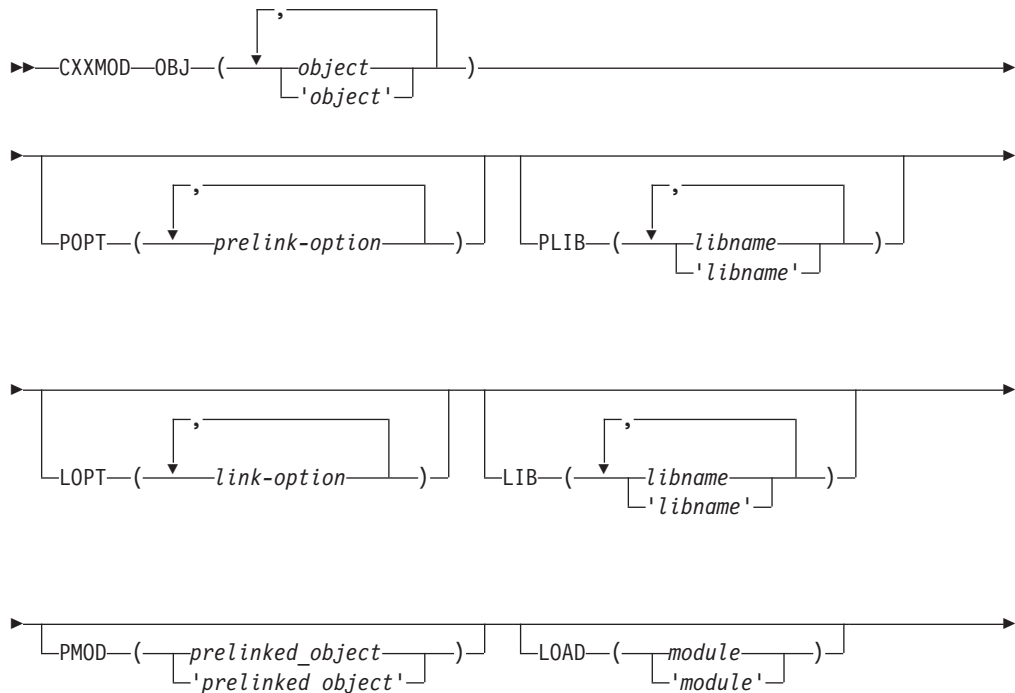

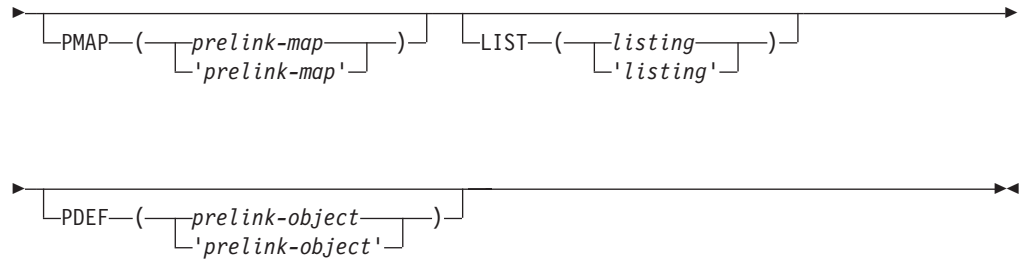

## CXXMOD

**OBJ** You must *always* specify the input file names on the OBJ keyword parameter. Each input file must be a C, C++ or assembler object module. Note that the file can be either a PDS member, a sequential file or a z/OS UNIX System Services file.

If the high-level qualifier of a file is not the same as your user prefix, you must use the fully qualified name of the file and place single quotation marks around the entire name.

**Note:** For z/OS UNIX file names, neither commas nor special characters need to be escaped. But you must place file names containing special characters or commas between single quotes. If a single quote is part of the file name, the quote must be specified twice. z/OS UNIX file names must be absolute names, that is they must begin with a slash (/).

**POPT** Prelinker options can be specified using the POPT keyword parameter. If the MAP prelink option is specified, a prelink map will be written to the file specified under the PMAP keyword parameter. For more details on generating a prelink map, see the information on the PMAP option below.

**LOPT** Linkage editor options can be specified using the LOPT keyword parameter. For details on how to generate a linkage editor listing, see the option LIST.

**PLIB** The library names that are to be used by the automatic call library facility of the prelinker must be specified on the PLIB keyword parameter. The default library used is the C++ base library, CEE.SCEECPP.

If the high-level qualifier of a library data set is not the same as your user prefix, you must use the fully qualified name of the data set and place single quotation marks around the entire name.

**LIB** If you want to specify libraries for the link step to resolve external references, use the LIB keyword parameter. The default library used is CEE.SCEELKED.

If the high-level qualifier of a library data set is not the same as your user prefix, you must use the fully qualified name of the data set and place single quotation marks around the entire name.

**PMOD** If you want to keep the output prelinked object module, specify the file that it should be placed in by using the PMOD keyword parameter. The default action is to create a file and erase it after the link is complete. The file can be either a data set or a z/OS UNIX file.

If the high-level qualifier of the output prelinked object module is not the same as your user prefix, you must use the fully qualified name of the file and place single quotation marks around the entire name.

**LOAD** To specify where the resultant load module should be placed, use the LOAD keyword parameter. The file can be either a data set or a z/OS UNIX file.

If the high-level qualifier of the load module is not the same as your user prefix, you must use the fully qualified name of the file and place single quotation marks around the entire name.

**LIST** To specify where the linkage editor listing should be placed, use the LIST keyword parameter. The file can be either a data set or a z/OS UNIX file. If you specify \*, the listing will be directed to your console.

If the high-level qualifier of the linkage editor listing is not the same as your user prefix, you must use the fully qualified name of the file and place single quotation marks around the entire name.

**PMAP** To specify where the Prelinker Map should be placed, use the PMAP keyword parameter. The file can be either a data set or a z/OS UNIX file. If you specify \*, the Prelinker Map will be directed to your console.

If the high-level qualifier of the Prelinker Map is not the same as your user prefix, you must use the fully qualified name of the file and place single quotation marks around the entire name.

**PDEF** To specify where the generated IMPORT control statements should be placed by the prelinker. The file can be either a data set or a z/OS UNIX file.

If the high-level qualifier of the IMPORT control statement listing is not the same as your user prefix, you must use the fully qualified name of the file and place single quotation marks around the entire name.

### Example of prelinking and linking under TSO

In the following example, the user prefix is RYAN and the input object module members MAIN and FN are in the PDS called RYAN.ACCOUNT.OBJ. A prelink map is to be generated and placed in 'RYAN.ACCOUNT.MAP(SALES)'. The load module will be placed in a PDS member called GROUP.ACCOUNT.LOAD(SALES). The linkage editor listing will be written to RYAN.ACCOUNT.LIST(SALES).

```
CXXMOD OBJ(ACCOUNT.OBJ(MAIN), ACCOUNT.OBJ(FN))
      POPT(MAP) LOPT(XREF, MAP)
      LOAD('GROUP.ACCOUNT.LOAD(SALES)') MAP(ACCOUNT.MAP(SALES))
      LIST(ACCOUNT.LIST(SALES))
```

In this instance, both the z/OS Language Environment stub library and the partitioned data set (library) SALESLIB are available as the automatic call libraries. The linkage editor LIBRARY control statement has the effect of concatenating any specified member names with the automatic call library.

## Using CPLINK

The CPLINK command has the following syntax:

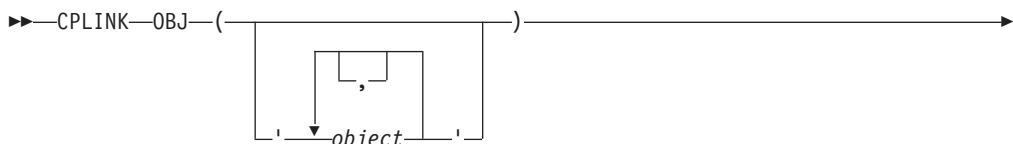

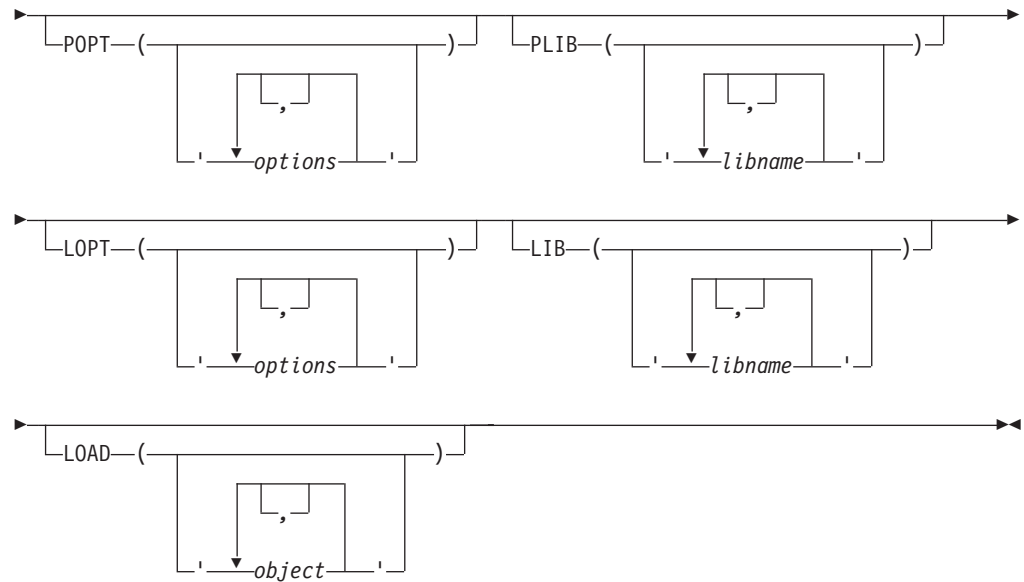

**OBJ** specifies an input data set name.

This is a required parameter. Each input data set must be a C object module compiled with the RENT or LONGNAME compiler options, or a compiled program (C or otherwise) having no static external data.

**POPT** specifies a string of prelink options.

The prelinker options available for CPLINK are the same as for z/OS batch. For example, if you want the prelinker to use the MAP option, specify the following:

```
CPLINK file name POPT('MAP')..
```

When you specify the prelink MAP option (as opposed to the link MAP option), the prelinker produces a file that shows the mapping of static external data. This map shows name, length, and address information. If there are any unresolved references or duplicate symbols during the prelink step, the map displays them.

**PLIB** specifies the library names that the prelinker uses for the automatic library call facility.

**LOPT** specifies a string of linkage editor options.

For example, if you want the prelink utility to use the MAP option, and the linkage editor to use the NOMAP option, use the following CLIST command:

```
CPLINK file name POPT('MAP') LOPT('NOMAP...')
```

**LIB** specifies any additional library or libraries that the TSO LINK command uses to resolve external references. These libraries are appended to the default C library functions.

**LOAD** specifies an output data set name.

If you do not specify an output data set name, a name is generated for you. The name that the CLIST generates consists of your user prefix, followed by CPOBJ.LOAD(TEMPNAME). For more information on

the file format for output data, refer to *z/OS MVS Program Management: User's Guide and Reference*.

## Examples

In the following example, your user prefix is RYAN, and the data set that contains the input object module is the partitioned data set RYAN.C.OBJ(INCCOMM). This example will generate a prelink listing without using the automatic call library. After the call, the load module is placed in the partitioned data set RYAN.CPOBJ.LOAD(TEMPNAME), and the prelink listing is placed in the sequential data set RYAN.CPOBJ.RMAP.

```
CPLINK OBJ('C.OBJ(INCCOMM)')
```

In the following examples, assume that your user prefix is PAUL, and the data set that contains the input object module is the partitioned data set PAUL.C.OBJ(INCPYRL). This example will not generate a prelink listing, and the automatic call facility will use the library RAINBOW.LIB.SUB. The load module is placed in the partitioned data set PAUL.TBD.LOAD(MOD).

```
/*-----  
/* Prelink and link 'PAUL.C.OBJ(INCPYRL)'  
/*-----  
//P0014001 EXEC EDCPL,  
//      INFILE='PAUL.C.OBJ(INCPYRL)',  
//      OUTFILE='PAUL.TBD.LOAD(MOD),DISP=SHR',  
//      PPARM='NOMAP,NONCAL',  
//      LPARM='AMODE(31),RMODE(ANY) '  
/*-----
```

Figure 56. Example of prelinking under z/OS batch

```
CPLINK OBJ(''PAUL.C.OBJ(INCPYRL)''')  
      POPT('NOMAP,NONCAL')  
      PLIB(''RAINBOW.LIB.SUB''')  
      LOAD('TBD.LOAD(MOD)')
```

Figure 57. Example of prelinking under TSO

## Using LINK

The general form of the TSO LINK command is:

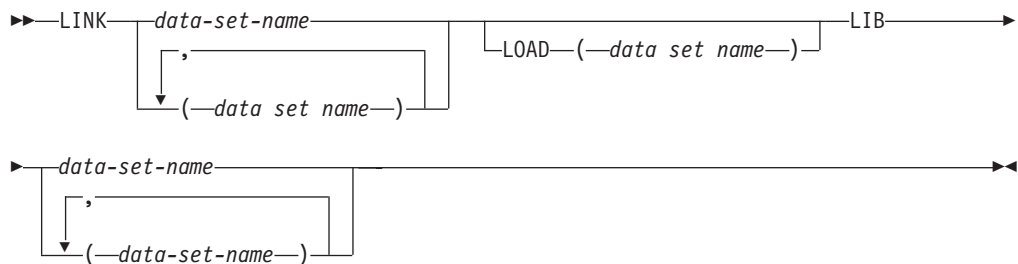

### Input to the LINK command

You must specify one or more object module names, or load module names, after the LINK keyword. For example, to link-edit *program2.obj*, using the Language Environment Library, you would issue the following:

```
LINK program2.obj LIB('CEE.SCEELKED')
```

#### Notes:

1. You must always specify 'CEE.SCEELKED' in the LIB operand. It is not required during the execution of a z/OS XL C/C++ program.

## LIB operand of the LINK command

The LIB operand specifies the names of data sets that are to be used to resolve external references by the automatic library call facility. Language Environment Library is made available to your program in this manner and must always be specified on the LIB operand. In the following example, *SALESLIB.LIB.SBRT2* is used to resolve external references used in *program2*.

```
LINK program2.obj LIB('CEE.SCEELKED.', 'SALESLIB.LIB.SBRT2')
```

A request coded this way searches CEE.SCEELKED and SALESLIB.LIB.SBRT2 to resolve external references.

## LOAD operand of the LINK command

In the LOAD operand, you can specify the name of the data set that is to hold the load module as follows:

```
LINK LOAD(load-mod-name(member)) LIB('CEE.SCEELKED')
```

The load module produced by the linkage editor must be a member in a partitioned data set.

If you do not specify a data set name for the load module, the system constructs a name by using the first data set name that appears after the keyword LINK, and it will be placed in a member of the *user-prefix.program-name.LOAD* data set. If the input data set is sequential and you do not specify a member name, TEMPNAME is used.

**Example:** The following example shows how to link-edit two object modules and place the resulting load module in member TEMPNAME of the *userid.LM.LOAD* data set.

```
LINK program1,program2 LOAD(lm)
```

You can also specify link-edit options in the link statement:

```
LINK program1 LOAD(lm) LET
```

Options for the linkage editor are discussed in “Output from the linkage editor” on page 556.

For more information about using the TSO command LINK, see *z/OS TSO/E Command Reference* .

## Specifying link-edit options through the TSO LINK command

TSO users specify link-edit options through the LINK command. For example, to use the MAP, LET, and NCAL options when the object module in SMITH.PROGRAM1.OBJ is placed in SMITH.PROGRAM1.LOAD(LM), enter:

```
LINK SMITH.PROGRAM1 'LOAD(LM) MAP LET NCAL'
```

You can use link-edit-options to display a map listing at your terminal:

```
LINK PROGRAM1 MAP PRINT(*)
```

## Storing load modules in a load library

If you want to link C functions, to store them in a load library, and to INCLUDE them later with main procedures, use the NCAL and LET linkage editor options.

---

## Prelinking and link-editing under the z/OS Shell

You can prelink and link your application under the shell by using the the OMVS prelinker option. The OMVS option causes the prelinker to change its processing of INCLUDE and LIBRARY control statements. The search library is pointed to immediately for any currently unresolved symbols. If the processing of subsequent INCLUDE or LIBRARY statements results in new or unresolved symbols, a previously encountered library will not be searched again. You may need another LIBRARY statement that points to the same library to search it again. For more information on the OMVS prelinker option, see Appendix B, “Prelinker and linkage editor options,” on page 591.

### Using your JCL

The example JCL in Figure 58 links to an archive library and to z/OS data sets. Include files may be PDS members, sequential files, or z/OS UNIX System Services files. Libraries may be partitioned data sets, or archive libraries.

```
//jobcard information...
//*-----
//*----- prelink -----
//RAWPLINK EXEC PGM=EDCPRLK,
//          PARM='OMVS,MEMORY,MAP,NONCAL'
//STEPLIB DD DISP=SHR,DSN=CEE.SCEERUN
//          DD DISP=SHR,DSN=CEE.SCEERUN2
//SYSMSGSGS DD DISP=SHR,DSN=CEE.SCEEMSGP(EDCPMSGG)
//SYSLIB DD DUMMY
//* object file
//DDOBJ1 DD PATH='/u/myuserid/callfoogoohoo.o'
//* PDS member
//DDOBJ2 DD DISP=SHR,DSN=MYUSERID.QAPARTNR.OBJ(MEM1)
//* archive library
//DDLIB3 DD PATH='/u/myuserid/mylibrary.a'
//* PDS Library
//DDLIB4 DD DISP=SHR,DSN=MYUSERID.QAPARTNR.OBJ
//SYSIN DD DATA,DLM=@@
INCLUDE DDOBJ1
INCLUDE DDOBJ2
LIBRARY DDLIB3
LIBRARY DDLIB4
@@
//SYSMOD DD DISP=SHR,DSN=MYUSERID.TEMP.OBJ(MEM1)
//SYSOUT DD SYSOUT=*
//SYSPRINT DD SYSOUT=*
//SYSDEFSD DD DUMMY
```

Figure 58. Using OMVS to prelink and link

The JCL in Figure 58 produces the following Prelinker Map:



```

=====
|                               Prelinker Map                               |
| CPLINK:5645001 V1 R8 M00 IBM Language Environment 2006/02/23 01:32:51 |
=====

Command Options. . . . . : NONCAL  MEMORY  ER      DUP      MAP
                        : OMVS    NOUPCASE

=====
|                               Object Resolution Warnings                               |
|-----|-----|-----|-----|-----|-----|-----|-----|-----|-----|-----|
WARNING EDC4015: Unresolved references are detected:
CEEBETBL CEER00TA goo      CEESG003 EDCINPL

=====
|                               File Map                                           |
|-----|-----|-----|-----|-----|-----|-----|-----|-----|-----|-----|
*ORIGIN  FILE ID  FILE NAME

      PI   00001  /u/myusrd/callfoogoo.hoo.o
      PI   00002  MYUSRID.QAPARTNR.OBJ(MEM1)
      A   00003  /u/myusrd/mylibrary.a(foo.o)
      A   00004  MYUSRID.QAPARTNR.OBJ(MEMH00)

*ORIGIN: P=primary input      PI=primary INCLUDE      SI=secondary INCLUDE
          A=automatic call     R=RENAME card       L=C Library
          IN=internal

=====
|                               Writable Static Map                               |
|-----|-----|-----|-----|-----|-----|-----|-----|-----|-----|-----|
INFORMATIONAL EDC4013: No map displayed as no writable static was found.

=====
|                               ESD Map of Defined and Long Names                               |
|-----|-----|-----|-----|-----|-----|-----|-----|-----|-----|-----|
*REASON  FILE ID  OUTPUT
          FILE ID  ESD NAME  INPUT NAME

      P   00001  CEESTART  CEESTART
      P   00001  CEEMAIN  CEEMAIN
      D   00001  MAIN     main
      D   00003  FOO      foo
      D   00003  GOO      goo
      D   00004  HOO      hoo
      P   00003  CEESG003 CEESG003
      P   00003  EDCINPL  EDCINPL
      D   00002  FUNC@IN@ func_in_MEM1

*REASON: P=#pragma or reserved      S=matches short name      R=RENAME card
          L=C Library                 U=UPCASE option          D=Default

=====
E N D   O F   P R E - L I N K A G E   M A P   =====

```

Figure 59. Prelinker Map produced when prelinking using OMVS

## Setting c89 to invoke the prelinker

The `c89`, `c++`, and `cc` utilities invoke the binder by default, unless the output file of the link-editing phase (`-o` option) is a PDS, in which case they use the prelinker.

You can set the `prefix_STEPS` environment for each of these utilities to use the prelinker for link-edit output files that are PDSEs or z/OS UNIX System Services files.

Once you set the `prefix_STEPS` environment variable for a utility so that the prelinker bit is turned on, that utility will always use the prelinker. If you want to use the binder, you must reset the `prefix_STEPS` environment variable.

For a complete description of `c89`, `c++`, and `cc`, see Chapter 20, “`c89` — Compiler invocation using host environment variables,” on page 489. For a description of the `prefix_STEPS` environment variable, see *z/OS UNIX System Services Command Reference*.

## Using the c89 utility

The `c89` utility specifies default values for some prelinker and linkage editor options. It also passes prelinker options and linkage editor options by using the `-W` option.

`c89` specifies prelinker and linkage editor options in order for it to provide the user with correct and consistent behavior. In order to determine exactly the prelinker and linkage editor options that `c89` specifies, you should use the `c89 -V` option.

Some `c89` options, such as `-V`, will change the settings of the prelinker options and the linkage editor options that `c89` specifies. For example, when you do not specify `-V`, `c89` specifies the prelinker option `NOMAP`, and when you specify `-V`, `c89` specifies the prelinker option `MAP`.

To explicitly override the options that `c89` specifies, use the `c89 -W` option. For example, to use the prelinker option `MAP` even when the `c89 -V` option is not specified, invoke

```
c89 -Wl,p,map ...
```

For a list of prelinker options and their uses, see “Prelinker options” on page 591.

---

## Prelinker control statement processing

The only control statements that the prelinker processes are `IMPORT`, `INCLUDE`, `LIBRARY`, and `RENAME` statements. The remaining control statements remain unchanged until the link step.

You can place the control statements in the input stream, or store them in a permanent data set. If you cannot fit all of the information on one control statement, you can use one or more continuations. The long name, for example, can be split across more than one statement. You can enable continuations in one of two ways:

- Place a non-blank character in column 72 of the statement that is to be continued. The continuation must begin in column 16 of the next statement.
- Enclose the name in single quotation marks. When such a name is continued across statements, it extends up to and includes column 71. Although column 72 is not considered part of the name, it must be non-blank for the name to be continued. On the following statement, column 1 must be blank (containing the `X'40'` character); the name then continues in column 2.

If you have a name that contains a single quotation mark, and you want to enclose the whole name in single quotation marks, put two single quotation marks next to each other where you want the single one to appear in the name.

**Example:** If you want the name

SymbolNameWithAQuote'InTheMiddle

specify it as follows:

'SymbolNameWithAQuote''InTheMiddle'

If you mix the two style of continuation in one control statement, after you continue a statement in column 2 due to a quote in the name, all subsequent statements will continue in column two.

## IMPORT control statement

The IMPORT control statement has the following syntax:

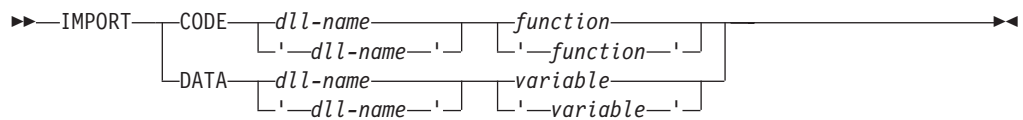

### *dll-name*

The name or alias of the load module for the DLL. The maximum length of an alias is 8 characters. However, the name itself can be a long name. The *dll-name* comes from the value specified on the DLLNAME prelinker option. For more information, see “Prelinker options” on page 591.

### *variable*

An exported *variable name*. It is a mixed case long name. To indicate a continuation across statements, either use a non-blank character in column 72 of the card and begin the next line in column 16, or enclose the name in single quotation marks, end the first line in column 71, and put a blank character in column 1 of the next line.

### *function*

An exported *function name*. It is a mixed case long name. You can indicate a continuation the same way you would for a variable.

The prelinker processes IMPORT statements, but does not pass them on to the link step.

## INCLUDE control statement

The INCLUDE control statement has the following syntax:

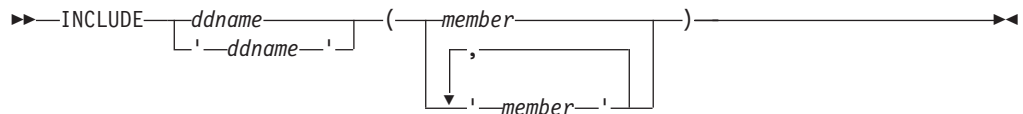

### *ddname*

A *ddname* associated with a file to be included. You can use the same kinds of continuations that you can for the *variable* on the IMPORT control statement.

*member*

The *member* of the DD to be included. You can use the same kinds of continuations that you can for the *variable* on the IMPORT control statement.

The prelinker processes INCLUDE statements like the z/OS linkage editor with the following exceptions:

An attempt is made to read the DD or member of the DD (whichever is specified). This request is resolved if the read is successful.

- INCLUDEs of identical member names are not allowed.
- INCLUDEs of both a ddname and a member from the same ddname are not allowed. The prelinker ignores the second INCLUDE.

**Note:** The INCLUDE control statement is removed and not placed in the prelinker output object module; the system linkage editor does not see the INCLUDE control statement.

For more information on the linkage editor, refer to *z/OS MVS Program Management: User's Guide and Reference* .

## LIBRARY control statement

The LIBRARY control statement has the following syntax:

### NOOMVS

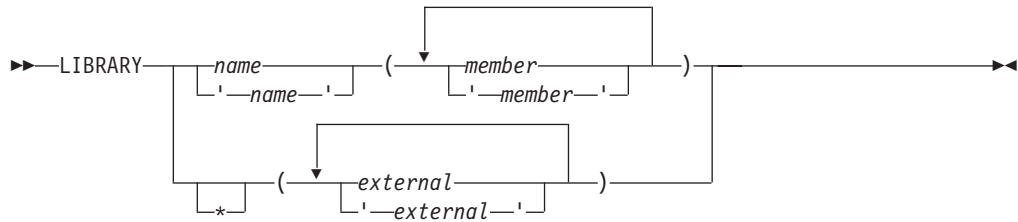

### OMVS



*name*

the *name* of a DD that defines a library, under z/OS. This could be a concatenation of one or more libraries that are created with or without the object library utility. You can use the same kinds of continuations that you can for the *variable* on the IMPORT control statement.

*member*

the name or alias of a member of the specified library. Because both short names and long names can be specified, case distinction is significant. If you use an long name, you can use the same kinds of continuations that you can for the *variable* on the IMPORT control statement.

Under z/OS, automatic library calls search the library and each subsequent library in the concatenation, if necessary, for the name instead of searching the primary input. If you specify the OMVS option, the only form of the LIBRARY card the prelinker accepts is LIBRARY *ddname* statement in SYSLIB.

*external*

an external reference that may be unresolved after primary input processing. An Automatic Library call will not resolve this external reference. Because both short names and long names can be specified, case distinction is significant. If you use an long name, you can use the same kinds of continuations that you can for the *variable* on the IMPORT control statement.

**Note:** The LIBRARY control statement is removed and not placed in the prelinker output object module; the system linkage editor does not see the LIBRARY control statement.

## RENAME control statement

The RENAME control statement has the following syntax:

### NOOMVS

```
►►—RENAME—long name—short name—SEARCH—►►  
          └─'—long name—'—┘                  └─SEARCH—┘
```

### OMVS

```
►►—RENAME—long name—short name—►►  
          └─'—long name—'—┘
```

*long name*

the *name* of the long name to be renamed on output. All occurrences of this long name are renamed. You can use the same kinds of continuations that you can for the *variable* on the IMPORT control statement.

*short name*

the *name* of the short name to which the long name will be changed. This name can be at most 8 characters, and case is respected.

### SEARCH

an optional parameter specifying that if the short name is undefined, the prelinker searches by an automatic library call for the definition of the short name. This is not available with the OMVS option.

The RENAME control statement is processed by the prelinker. You can use this statement to do the following:

- Explicitly override the default name that is given to an long name when an long name is mapped to a short name.

You can explicitly control the names that are presented to the system linkage editor so that external variable and function names are consistent from one linkage editor run to the next. This consistency makes it easier to recognize control section and label names that appear in system dumps and linkage editor listings. Another mapping rule can provide the suitable name, but if you need to replace the linkage editor control section, you need to maintain consistent names. See “Mapping long names to short names” on page 553 for a description of this rule.

- Explicitly bind a long name to a short name. This binding may be necessary when linking with other languages that use a different name for the same object.

A RENAME control statement cannot be used to rename a writable static object because its name is not contained in the output from the prelinker.

You can place RENAME control statements before, between, or after other control statements or object modules. An object module can contain only RENAME statements. RENAME statements can also be placed in input that is included because of other RENAME statements.

### Usage notes

- A RENAME statement is ignored if the long name is not encountered in the input.
- A RENAME statement for an long name is valid provided *all* of the following are true:
  - The long name was not already mapped because of a rule that preceded the RENAME statement rule in the hierarchy described in “Mapping long names to short names” on page 553.
  - The long name was not already mapped because of a previous valid RENAME statement for the long name.
  - The short name is not itself an long name. This rule holds true even if the short name has its own RENAME statement.
  - A previous valid RENAME statement did not rename another long name to the same short name.
  - Either the long name or the short name is not defined. Either the long name or the short name can be defined, but not both. This rule holds true even if the short name has its own RENAME statement.

---

## Reentrancy

This section discusses how to use the prelinker to make your program reentrant. For detailed information on reentrancy, see *z/OS XL C/C++ Programming Guide*.

Reentrant programs are structured to allow more than one user to share a single copy of a load module or to use a load module repeatedly without reloading it.

### Natural or constructed reentrancy

Reentrant programs can be categorized as having natural or constructed reentrancy. Programs that contain no references to the writable static objects that are listed above have natural reentrancy. Programs that refer to writable static objects must be processed with the IBM Language Environment Prelinker to make them reentrant; such programs have constructed reentrancy.

If you are using C, you do not need to use the RENT compiler option if your program is naturally reentrant.

Because all C++ programs are categorized as having constructed reentrancy, C++ code must be bound by the binder using the DYNAM(DLL) option. Alternatively, the C++ code must be processed by the prelinker before being processed by the linkage editor.

### Using the prelinker to make your program reentrant

The prelinker concatenates compile-time initialization information (for writable static) from one or more object modules into a single initialization unit. In the process, the writable static part is mapped.

If you are not using the binder, and your program contains writable static, you can use the prelinker to make your program reentrant. If the program is C and does not contain writable static, you do not need to use the prelinker to ensure reentrancy; the program is naturally reentrant. C++ programs always contain writable static.

If you compile your code and wish to link it using the z/OS system link procedures such as IEWL, you must first call the prelinker.

The z/OS UNIX System Services features require that all z/OS XL C/C++ application programs be reentrant. If you are using the c89 utility, it automatically invokes the z/OS XL C/C++ compiler with the RENT option and also invokes the prelinker.

The prelinker is not a post-compiler. That is, you do not prelink the object modules individually into separate prelinked object modules as if running the prelinker was an extension of the compile step. Instead, you prelink all the object modules together in the same job into one output prelinked object module. This is because the prelinker cannot process each object deck one at a time: it assigns offsets to each data item in the writable static area for the program, and thus needs all of the object decks that refer to data items in writable static input in a single step.

The prelinker does all of the following:

- It maps input long names from the object modules to output short names (8 characters maximum)
- It collects compile-time initialization information on static objects
- It collects constructor calls and destructor calls for static objects in C++
- It collects DLL information
- It collects objects that exist in writable static into one area by assigning an offset within the writable static area to each object
- It removes all relocation and name information of objects in the writable static area

The output of the prelinker is a single prelinked object module. You can link this object module only on the same platform where you prelinked it.

Because the prelinker maps names and removes the relocation information, you cannot use the resulting object module as input for another prelink. Also, you cannot use the linkage editor to replace a control section (CSECT) that either defines or references writable static objects.

## Steps for generating a reentrant load module in C

Perform the following steps to generate a reentrant load module in C:

1. Determine whether or not your program contains writable static. If you are unsure about whether your program contains writable static, compile it with the RENT option. Invoking the prelinker with the MAP option and the object module as input produces a Prelinker Map. Any writable static data in the object module appears in the writable static section of the map. Unresolved writable static references may also appear in the map as errors.

If you see the symbol `@STATIC` defined in the writable static section, your code contains unnamed writable static such as modifiable literal strings, or variables with the static qualifier. To ensure that literal strings stay in the code area, recompile with **`#pragma strings(readonly)`**, and prelink again.

2. If your program contains no writable static, compile your program as you would normally (without any special compiler options), and then go directly to step 4.

---

3. If your program contains writable static, you must compile your C source files with the RENT compiler option.

---

4. Use the z/OS Language Environment prelinker to combine *all* input object modules into a single output object module.

**Notes:**

a. The prelinker can handle compiled programs in languages other than C or C++. However, only C, C++, OO COBOL, or assembler code using the macros EDCDXD and EDCLA may refer to writable static.

b. You cannot use the output object module as further input to the z/OS Language Environment prelinker.

---

5. Optionally, you can use the output object module to link the program in the LPA or ELPA area of the system.

---

6. Under the z/OS shell, you can run the installed program by invoking it from z/OS UNIX System Services. To do so you must install the program in z/OS UNIX, and, from a superuser ID, enter a **chmod** Shell command to turn on the sticky bit for the program. See *z/OS UNIX System Services Planning* for more information.

---

## Steps for generating a reentrant load module in C++

Perform the following steps to generate a reentrant load module in C++:

1. Compile your source code.

If you see the symbol @STATIC defined in the writable static section, your code contains unnamed writable static such as modifiable literal strings, or variables with the static qualifier. To ensure that literal strings stay in the code area, recompile with **#pragma strings(readonly)**, and prelink again.

---

2. Use the supplied prelink and link utilities on the module. Under TSO, you can use the CXXMOD REXX EXEC to both prelink and link your module. Under z/OS batch, use these JCL procedures:

- CBCCL: compile and link
- CBCL: link
- CBCCLG: compile, link, and go
- CBCLG: link and go

For all of these, linking involves two steps: invocation of the prelinker, and then a call to the system linker.

---



---

## Resolving multiple definitions of the same template function

**Note:** For complete information on using C++ templates, see *z/OS XL C/C++ Programming Guide*.

When the prelinker generates template functions, it resolves multiple function definitions as follows:

- If a function has both a specialization and a generalization, the specialization takes precedence.
- If there is more than one specialization, the prelinker issues a warning message.

Because the link step does not remove unused instantiations from the executable program, instantiating the same functions in multiple compilation units may generate very large executable programs.

---

## External variables

For more information on external variables, see *z/OS XL C/C++ Programming Guide*.

The POSIX 1003.1 and X/Open CAE Specification 4.2 (XPG4.2) require that the C system header files declare certain external (global) variables. Additional variables are defined for use with POSIX or XPG4.2 functions. If you define one of the POSIX or XPG4 feature test macros and include one of these headers, the global variables will be declared in your program. These global variables are treated differently than other global variables in a multi-threaded environment (values are thread-specific rather than global to the process) and across a call to a fetched module (values are propagated rather than module-specific). To access the global variables, you must use either C with the RENT compiler option, C++, or the XPLINK compiler option. If you are not using XPLINK, you must also specify the SCEEOBJ autocall library. The SCEEOBJ library must be specified before the SCEELKEX and the SCEELKED libraries in the bind step. If the SCEEOBJ library is specified after the SCEELKEX and SCEELKED libraries, the bind step will resolve the external variables to the user application, but at run-time Language Environment will not use those same external variables, and so run-time errors can occur. You are also able to access the external variables by defining the `_SHARE_EXT_VARS` feature test macro during the compile step (or the `_SHR_name` feature test macro corresponding to the variable names you are accessing). For further information on feature test macros, see *z/OS XL C/C++ Run-Time Library Reference*. In this case, functions which access the thread-specific values of the external variables are provided for use in a multi-threaded environment. If you use the XPLINK compiler option for a 32-bit program, the global variables are resolved by import using the CELHS003 member of the SCEELIB data set. The thread-specific values are always used.

For a dynamically called DLL module to share access to the POSIX external variables, with its caller, the DLL module must define the `_SHARE_EXT_VARS` feature test macro. For more information, see the section on feature test macros in the *z/OS XL C/C++ Run-Time Library Reference*.



---

## Appendix B. Prelinker and linkage editor options

This chapter contains the prelink options and link options for your programs under z/OS Language Environment. For more information on using the z/OS Language Environment Prelinker, see Appendix A, “Prelinking and linking z/OS XL C/C++ programs,” on page 549.

---

### Prelinker options

The following section describes the prelink options available in z/OS XL C/C++ by using z/OS Language Environment.

#### DLLNAME(dll-name)

DLLNAME specifies the DLL name that appears on generated IMPORT control statements, described in “IMPORT control statement” on page 583. If you specify the DLLNAME option, the prelinker sets the DLL name to the value that you listed on the option.

If you do not specify DLLNAME, the prelinker sets the DLL name to the name that appeared on the last NAME control statement that it processed. If there are no NAME control statements, and the output object module of the prelinker is a PDS member, it sets the DLL name to the name of that member. Otherwise, the prelinker sets the DLL name to the value TEMPNAME, and issues a warning.

#### DUP | NODUP

DEFAULT: DUP

DUP specifies that if duplicate symbols are detected, their names should be directed to the console, and the return code minimally set to a warning level of 4. NODUP does not affect the return code setting when the prelinker detects duplicates.

#### DYNAM | NODYNAM

DEFAULT: DYNAM

When the NODYNAM option is in effect, export symbol processing is not performed by the prelinker even when export symbols are present in the input objects. The side-deck is not created and the resulting module will not be a DLL. Specify NODYNAM for prelinked C/C++ programs involved in COBOL C/C++ ILC calls.

#### ER | NOER

DEFAULT: ER

**Note:** For the z/OS UNIX Systems Services environment, the default is NOER.

If there are unresolved symbols, ER instructs the prelinker to write a messages and a list of unresolved symbols to the console. If there are unresolved references, the prelinker sets the return code to a minimum warning level of 4. If there are unresolved writable static references, the prelinker sets the return code to a minimum error level of 8. If you use NOER, the prelinker does not write the list of unresolved symbols to the console. If there are unresolved references, the return code is not affected. If there are unresolved writable static references, prelinker sets the return code to a minimum warning level of 4.

## MAP | NOMAP

DEFAULT: MAP

In the z/OS UNIX System Services environment, the c89, cc, and c++ utilities specify MAP when you use the -V flag, and NOMAP when you do not.

The MAP option specifies that the prelinker should generate a prelink listing. See “z/OS Language Environment Prelinker Map” on page 564 for a description of the map.

## MEMORY | NOMEMORY

DEFAULT: NOMEMORY

The MEMORY option instructs the prelinker to retain in storage, for the duration of the prelink step, those object modules that it reads and processes.

You can use the MEMORY option to increase prelinker speed. However, you may require additional memory to use this option. If you use MEMORY and the prelink fails because of a storage error, you must increase your storage size or use the prelinker without the MEMORY option.

## NCAL | NONCAL

DEFAULT: NONCAL

The NCAL option specifies that the prelinker should not use the automatic library call to resolve unresolved references.

The prelinker performs an automatic library call when you specify the NONCAL option. An automatic library call applies to a library of user routines. For NOOMVS, the data set must be partitioned, but for OMVS the data set that the prelinker searches can be either a PDS or an archive library. Automatic library call cannot apply to a library that contains load modules.

**Note:** If you are prelinking C++ object modules, you must use the NONCAL option and include the C++ base library in the CEE.SCEECP data set in your SYSLIB concatenation.

## OMVS | NOOMVS

DEFAULT: NOOMVS

The OMVS option causes the prelinker to change the way that it processes INCLUDE and LIBRARY control statements. The c89 utility turns on the OE option (which maps to the OMVS option) by default. Object files and object libraries from c89 are passed as primary input to the prelinker. Object files are passed via INCLUDE control statements, and object libraries via LIBRARY control statements. Only those LIBRARY control statements that are included in primary input are accepted by the prelinker. Their syntax is:

```
LIBRARY libname
```

where *libname* is the name of a DD that defines a library. The library may be either an archive file created through the ar utility or a partitioned data set (PDS) with object modules as members. The prelinker uses LIBRARY control statements like SYSLIBs, to resolve symbols through autocalls.

When you specify the OMVS option, the prelinker accepts INCLUDE and LIBRARY statements which refer to z/OS UNIX System Services files (PATH=) and data set name (DSNAME=) allocations.

When you use the OMVS option, the order in which object files and object libraries are passed is significant. The prelinker processes its primary input sequentially. It searches the library that you specified on the LIBRARY statement only at the point where it encounters the LIBRARY statement. It does not refer to that library or processes it again. For example, if you pass your object files and object libraries as follows:

```
c89 file1.o lib1.a file2.o lib2.a
```

The prelinker processes the INCLUDE control statement for file1.o, and incorporates new symbol definitions and unresolved references from the object file into the output file. The prelinker then processes the LIBRARY control statement for lib1.a, and searches the library for currently unresolved symbols. It then processes file2.o followed by lib2.a. If the processing of file2.o results in unresolved symbols, the prelinker will not search the library lib1.a again, because it has already processed it. If you have unresolved symbols that may be defined in a library that has already been processed, you must specify a new LIBRARY statement after your INCLUDE statement to resolve those symbols. You can do this on a **c89** command line as follows:

```
c89 file1.o lib1.a file2.o lib1.a lib2.a
```

RENAME control statements are processed on output from the prelinker, after all of its input has been processed. Because a library can be processed once only, the SEARCH option on the RENAME control statement has no effect.

**Note:** The OE prelinker option maps to the OMVS prelinker option.

## UPCASE | NOUPCASE

DEFAULT: NOUPCASE

The UPCASE option enforces the uppercase mapping of long names that are 8 characters or fewer and have not been explicitly mapped by another mechanism. These long names are uppercased (with \_ mapped to @), and names that begin with IBM or CEE are changed to IB\$ and CE\$, respectively.

The UPCASE option is useful when calling routines that are written in languages other than z/OS XL C/C++. For example, in COBOL and assembler, all external names are in uppercase. So, if the names are coded in lowercase in the z/OS XL C/C++ program and you use the LONGNAME option, the names will not match by default. You can use the UPCASE option to enforce this matching. You can also use the RENAME control statement for this purpose.

**Note:** Use of this option can be dangerous, since names with a length of 8 characters or less will lose their case sensitivity. A better way to get the linkage and names correct is through the use of the appropriate pragmas.

---

## Linkage editor options

You can specify link-edit options in either of two ways:

- Through JCL
- Through the TSO LINK command

For a description of link-edit options, see Chapter 5, “Binder options and control statements,” on page 285 or *z/OS MVS Program Management: User’s Guide and Reference*.

---

## Appendix C. Diagnosing problems

This appendix tells you how to diagnose failures in the z/OS XL C/C++ compiler. If you discover that the problem is a valid compiler problem, refer to [techsupport.services.ibm.com/guides/handbook.html](http://techsupport.services.ibm.com/guides/handbook.html) for further information on obtaining IBM service and support.

---

### Problem checklist

The following list contains suggestions to help you rule out some common sources of problems.

- Check that the program has not changed since you last compiled or executed it successfully. If it has, examine the changes. If the error occurs in the changed code and you cannot correct it, note the change that caused the error. Whenever possible, you should retain copies of both the original and the changed source programs.
- Be sure to correct all problems that are diagnosed by error messages, and ensure that the messages that were previously generated have no correlation to the current problem. Be sure to pay attention to warning messages.
- The message prefix can identify the system or subsystem that issued the message. This can help you determine the cause of the problem. Following are some of the prefixes and their origins.
  - CCN - indicates messages from the z/OS XL C/C++ compiler, its utility components, or the z/OS XL C/C++ IPA Link step. Information on the messages is found in *z/OS XL C/C++ Messages*.
  - EDC - a numeric portion between 0090 and 0096 indicates a *severe error*, and the solution should be self-evident from the accompanying text. If it is not, contact your Service Representative. If the numeric portion is in the 4000 series, this specifically relates to the prelinker and *alias* utility. Otherwise, the message relates to the z/OS XL C/C++-specific messages from the run-time environment. Information on Language Environment messages is found in *z/OS Language Environment Run-Time Messages*.
  - CEE - for language-independent messages from the common execution environment (CEE) library component of z/OS Language Environment. Information on Language Environment messages is found in *z/OS Language Environment Run-Time Messages*.
  - IBM, PLI, IGZ - for language-specific messages from z/OS Language Environment. Information on Language Environment messages is found in *z/OS Language Environment Run-Time Messages*.
  - CLB - for messages that relate to z/OS class libraries. See *z/OS XL C/C++ Messages* for more information.
  - BPX - messages that relate to z/OS UNIX System Services.
  - FSUM - messages for the c89 and xlc utilities.

You can cross reference the prefix to the message manual in most cases by using the table at the beginning of the *z/OS MVS System Messages* volumes which accompany the z/OS operating system.

- Ensure that you are compiling the correct version of the source code. It is possible that you have incorrectly indicated the location of your source file. For example, check your high-level qualifiers.
- In any program failure, keep a record of the conditions and options in effect at the time the problem occurred. The listing file shows the options. To get the

listing, compile with the SOURCE option. The listing only contains options that appear after the command line is processed, hence C **#pragma options** do not appear.

Information about some of the options appears as a comment at the end of the object file. For both C or C++ compilers, there is always a comment showing the OPTIMIZE level. For C compilers, information about some of the options (for example, ALIAS, GONUMBER, INLINE, RENT, or UPCONV options) is included only if you specify the option when you compile. Note any changes from the previous compilation.

- Your installation may have received an IBM Program Temporary Fix (PTF) for the problem. Verify that you have received all issued PTFs and have installed them, so that your installation is at the current maintenance level. Specifying the compiler option PHASEID when doing a compile provides information about the maintenance level of each compiler component (phase).
- The preventive service planning (PSP) bucket, which is an online database available to IBM customers through IBM service channels. It gives information about product installation problems and other problems. See the z/OS Program Directory for more details.
- Use the Debug Tool, dbx (for z/OS UNIX System Services) or some other debugging aid to determine the statement where the program fails and possible causes of the failure.
- If a failing application is communicating with other IBM products, make sure that it uses the correct interface procedure as documented in *z/OS XL C/C++ Programming Guide*. In many cases, you can localize the failing condition by taking out the function calls or making them no-ops.
- If your application has been developed on a different platform (such as a microcomputer or workstation) and you try to compile and run using the z/OS XL C/C++ compiler, the following may cause problems:
  - The source code does not support the applicable following standards:
    - *ISO C Standard*
    - *ISO C++ Standard*
  - The source code includes dependencies on the ASCII character set or uses the long double data type in the IEEE floating-point format. You need the ASCII compiler option to process the ASCII characters, and you need the FLOAT(IEEE) option to process IEEE floating-point data types. Note that the IEEE long double data types may have different sizes on a different platform.
  - The source code is system dependent
- If your application was prelinked, make sure that the prelinking was successful as indicated in Appendix A, “Prelinking and linking z/OS XL C/C++ programs,” on page 549.

---

## When does the error occur?

Determine when the problem is occurring (at compile time, bind time, prelink time, link time or run time), and use the procedures in the appropriate list on the following pages. If the problem occurs when using z/OS Language Environment, for prelink-time and run-time diagnosis and debugging errors you should use *z/OS Language Environment Customization* and *z/OS Language Environment Debugging Guide*. For bind-time and link-time diagnosis, refer to *z/OS MVS Program Management: User's Guide and Reference*.



After you identify the failure, you can write a small, self-contained test case that does not have any dependencies on third-party header files and libraries and that recreates the problem. A test case helps you to isolate the problem and to report problems to IBM.

To create a small test case from a large program that appears to be failing, try the suggestions listed below, after you have either backed up or made a copy of your original source code. Begin with the suggestion that seems most appropriate for the problem that you are having. If the problem persists after you have tried one of the steps below, try another in the list. Continue to break your program down until you obtain the smallest possible segment of code that still reproduces the error. Compile with the PPNLY option and send the expanded file as your source code. This is to ensure that all embedded header files are included. Save this last failing test case because you might need it if you have to contact an IBM Support Center.

Remove any code that has not been processed at the time of failure (except for code necessary to ensure the syntactic and semantic validity of the program).

Find unreferenced variables using the IPA(XREF) option, the CHECKOUT(GEN) option, which is for C only, or the INFO(USE) option, which is for C++ only, and remove the unreferenced variables.

Remove all code and declarations from the body of any other functions that are not necessary to reproduce the problem. The function should be removed if it is not necessary.

If your program uses structure variables, try replacing them with scalar variables.

## Steps for problem diagnosis using optimization levels

**Before you begin:** For diagnostic purposes, you should always begin by using the simplest optimization level on your program. Once you address all problems at your current level, progress toward the more complex levels of optimization.

Perform the following steps to progress through the various levels of optimization:

1. Begin with a non-IPA compile and link using progressively higher levels of optimization:
  - OPT(0)
  - OPT(2)
  - OPT(3)

If your program works successfully at OPT(0) and fails at OPT(2), try rebuilding the program specifying the compiler option NOANSIALIAS and re-running. You may suffer a performance penalty for this as the optimizer has to make worst-case aliasing assumptions but it may resolve the problem.

2. Use IPA(OBJONLY) and OPT(2). This adds the IPA compile-time optimizations and often locates the problematic source file before you invest a lot of time and effort diagnosing problems in your code at IPA Link time.
3. Use the full IPA Compile and IPA(Level(1)) Link path. IPA Compile-time optimizations are performed on the IPA object. IPA Link-time optimizations are performed on the entire application.

4. Use the full IPA Compile and IPA(Level(2)) Link path. IPA Level 2 performs additional link-time optimizations.
- 

You know you are done when you have exploited all optimizations offered by the compiler.

## Steps for diagnosing errors that occur at compile time

Perform the following steps to diagnose errors that occur at compile time:

1. If your program uses any of the library routines, insert an `#include` directive for the appropriate header files. Also insert an `#include` directive for any of your own header files. The compiler uses function prototypes, when present, to help detect type mismatches on function calls. You can use the C CHECKOUT option to find missing prototyping. Note that z/OS XL C++ does not allow missing prototypes.

---

2. Compile your program with either the CHECKOUT (C-only) or the INFO (C++ only) option. These options specify that the compiler is to give informational messages that indicate possible programming errors. These options will give messages about such things as variables that are never used, and the tracing of `#include` files.

---

3. Compile your program with the PPOONLY option to see the results of all `#define` and `#include` statements. This option also expands all macros; a macro may have a different result from the one you intended.

---

4. If your program was originally compiled using the OPT(2) compiler option, try to recompile it using the NOOPTIMIZE option, and run it. If you can successfully compile and run the program with NOOPTIMIZE, you have bypassed the problem, but not solved it. This does not however, exclude the possibility of an error in your program. You can run the program as a temporary measure, until you find a permanent solution. If your program works successfully at OPT(0) and fails at OPT(2), try rebuilding the program specifying the compiler option NOANSIALIAS and re-running. You may suffer a performance penalty for this as the optimizer has to make worst-case aliasing assumptions but it may resolve the problem.

---

5. If you compiled your program with either the SEQUENCE or the MARGINS option, the error may be due to a loss of code. If you compiled the source code with the NOSEQUENCE option, the compiler will try to parse the sequence numbers as code, often with surprising results. This can happen in a source file that was meant to be compiled with margins but was actually compiled without margins or different margins (available in z/OS XL C only).  
Either oversight could result in syntax errors or unexpected results when your program runs. Try recompiling the program with either the NOSEQUENCE or the NOMARGINS option.

---

6. Your source file may contain characters that are not supported by your terminal. You have two options at this point:

- a. Replace any characters that cannot be displayed in literals with the corresponding digraph (specify the DIGRAPH compiler option), or trigraph representation, or the corresponding escape sequence. Verify that the error did not result from using one of these incorrectly.
  - b. You can use the **#pragma filetag** support and the LOCALE option to allow the compiler to work with non-standard code pages. See *z/OS XL C/C++ Programming Guide* for more details on **#pragma filetag**.
- 
7. Check for duplicate static constructors and destructors in your C++ source. Entries for constructors are created in the object and in a table. When a static constructor is removed, the entry in the object is removed, but the table entry stays. This will cause the static constructor and destructor to be called multiple times. If the destructor deletes (or frees) dynamically allocated storage that is associated with a pointer, it will tend to fail on subsequent invocations.
- 
8. A compile-time abend can indicate an error in the compiler. An unsuccessful compilation due to an error in the source code or an error from the operating system should result in error messages, not an abend. However, the cause of the compiler failure may be a syntax error or an error from the operating system. Use the PHASEID compiler option to obtain the maintenance service level of the compiler, as well as the name of the failing compiler component, in the output listing.
- 

If you still have a compilation problem, contact IBM support.

## Steps for diagnosing errors that occur at IPA Link time

Perform the following steps to diagnose errors that occur at IPA Link time:

1. Ensure that the region that is used for the IPA Link step is sufficient. The REGION system parameter should be set to at least 1500 MB and the MEMLIMIT system parameter should be set to at least 3000 MB. For further information, see “Specifying compiler options under z/OS UNIX System Services” on page 49.
- 
2. Ensure that the object module which defines main() contains an IPA object.
- 
3. Ensure that all application program parts (object modules, load modules) and all necessary interface libraries (Language Environment object modules and load module, SQL, CICS, etc) are made available to the IPA Link step.
- 
4. Ensure that the IPA Compile step has processed all object modules for which source is available.
- 
5. Use the IPA(LINK,MAP) option to obtain an IPA Link listing.
- 
6. Do not attempt to IPA Link unsupported file formats, such as Program Objects.
-

7. Verify that there are no unresolved symbol references. All user symbols must be resolved before invoking the binder (or prelinker and linkage editor). Any run-time symbol references generated by IPA Link must be resolved by the subsequent step to that no unresolved symbols remain.

If you have unresolved symbols, make sure that the definition of an object and all its references are used consistently in both the code area and the writable static area. Also, make sure that symbol references appear consistently in the same case.

If you have unresolved symbols after using autocall, and you are searching for longnamed or writable static objects, make sure that each object module library has a current directory generated by the C370LIB utility. Without this directory, autocall can only be done on the member name of the object module and not on what is actually defined within the member.

- 
8. If problems occur during IPA Link processing of DLL code, note that a symbol can only be imported if all of the following conditions hold true:
    - The symbol remains unresolved after autocall
    - Only DLL references were seen for the symbol
    - An IMPORT control statement was encountered for the symbol

- 
9. A compiler ABEND during IPA Link step processing can indicate an error in the compiler. An unsuccessful IPA Link due to an error in the program source code, an invalid object module, an invalid load module, or an error from the operating system should result in error messages, not an ABEND.

If the compiler ABEND during IPA Link step processing is related to an invalid IPA object module, it will require further diagnosis:

- Save and recompile any IPA object modules created by a previous release. If the problem is corrected, contact IBM service and be prepared to supply the relevant source (PPONLY) and IPA object modules. Try compiling at OPT(2), and then OPT(2) plus IPA(OBJONLY). If you are linking with IPA Level 2, try linking with Level 1. Ensure that you have first tried lower optimization levels. Perform a binary search for the invalid IPA object module. To do this, compile one half of your source files with NOIPA (with or without OBJONLY), and the other half with IPA. When the IPA Link succeeds, reduce the set of NOIPA objects until you identify the compilation unit which produced the invalid IPA objects. Note that the object module which defines `main()` must always contain IPA object. It may be necessary to break the source file with `main()` into multiple pieces to determine the point of failure.

---

You should now have a clean IPA Link compilation. If you still have a problem with the IPA Link step, contact IBM support.

## The error occurs at bind time

For information on bind-time errors, see “Error recovery” on page 402.

## The error occurs at prelink time

If the error occurs at prelink time:

- Do not prelink the object modules separately.
- Use the prelinker option MAP to obtain a full map of input data sets and symbols.

- Use the prelinker options DUP and ER to obtain a full list of duplicate and unresolved symbols.
- If you have unresolved symbols, make sure that the definition of an object and all references to that object are used consistently in both the code area and the writable static area. Also, make sure that symbol references appear consistently in the same case.
- A symbol can only be imported if all of the following conditions hold true:
  - The symbol remains unresolved after `autocall`.
  - Only DLL references were seen for the symbol.
  - An `IMPORT` control statement was encountered for the symbol.

For more information on using DLL, see “Using DLLs” on page 559, or the DLL description in *z/OS XL C/C++ Programming Guide*.

- If you have unresolved symbols after using `autocall`, make sure that the libraries that are searched contain only object modules and no load modules. If you are searching for longnamed or writable static objects, make sure that each library has a current directory member generated by the C370LIB utility. Without this directory, `autocall` can only be done on the member name of the object module and not on what is actually defined within the member.
- Only naturally reentrant code can be linked with the output of the prelinker. For more information on reentrancy, see *z/OS XL C/C++ Programming Guide*.

## The error occurs at link time

If the error occurs at link time:

- If you have a link-time error while working with the XL C/C++ component of z/OS Language Environment, you can find diagnostics and debugging information in *z/OS MVS Program Management: User's Guide and Reference*.
- If you have a link-time error while working with common execution environment (CEE) library component of z/OS Language Environment, you can find diagnostics and debugging information for link-time errors in *z/OS Language Environment Customization* and *z/OS Language Environment Debugging Guide*.

## Steps for diagnosing errors that occur at run time

**Before you begin:** If you are diagnosing run-time errors when executing with z/OS Language Environment, refer to *z/OS Language Environment Customization* and *z/OS Language Environment Debugging Guide*.

Perform the following steps to diagnose errors that occur at run time:

1. Specify one or more of the following compiler options, in addition to the options originally specified, to produce the most diagnostic information:

| Option    | Information produced   |
|-----------|--|
| AGGREGATE | (C only). Aggregate layout.  |
| ATTRIBUTE | (C++ only). Cross reference listing with attribute information.  |
| CHECKOUT  | (C only). Indication of possible programming errors.   |
| DEBUG     | Instructs the compiler to generate debug information based on the DWARF Version 3 debugging information format, which has been developed by the UNIX International Programming Languages Special Interest Group (SIG), and is an industry standard format. |
| EXPMAC    | Macro expansions with the original source.   |
| FLAG      | Specifies the minimum message severity level that you want returned from the compiler.   |

|          |  |
|----------|--|
| GONUMBER | Generates line number information that corresponds to input source files.  |
| INFO     | (C++ only). Indication of possible programming errors.   |
| INLINE   | Inline Summary and Detailed Call Structure Reports. (Specify with the REPORT suboption.)   |
| INLRPT   | Generates a report on status of functions that were inlined. The OPTIMIZE option must also be specified.   |
| LIST     | Listing of the pseudo-assembly listing produced by the compiler.   |
| OFFSET   | Offset addresses of functions in the listing.  |
| PPONLY   | Completely expanded C or C++ source code, by activating the preprocessor (PPONLY). The output shows, for example, all the #include and #define directives.   |
| SHOWINC  | All included text in the listing.  |
| SOURCE   | Listing of the source file.  |
| TEST     | For 31-bit only, used to obtain information about the contents of variables at the point of the error, and to enable the use of Debug Tool.                  |
| XREF     | Cross reference listing with reference, definition, and modification information. If you specify ATTRIBUTE, the listing also contains attribute information. |

- 
2. If the failure is in a statement that can be isolated, for example, an if, switch, for, while, or do-while statement, try placing the failing statement in the mainline code. If the problem is occurring as a result of a switch statement, make sure that you have “breaks” on all appropriate statements.
- 
3. If you have used the compiler options RENT or NORENT in **#pragma options** or **#pragma variable** statements, and compiled your program at OPT(2), you can detect a possible pointer initialization error by compiling your program at OPT(0).
- 
4. Check if you are running IBM C/370 Version 1 or Version 2 modules. Some IBM C/370 Version 1 and Version 2 modules may not be compatible with z/OS Language Environment. In some cases, old and new modules that run separately may not run together. You may need to recompile or relink the old modules, or change their source. *z/OS XL C/C++ Compiler and Run-Time Migration Guide for the Application Programmer* documents these solutions.
- 
5. If IPA Link processed the program:
    - a. Ensure that the program functions correctly when compiled NOIPA at the same OPT level.
    - b. Subprograms (functions and C++ methods) which are not referenced will be removed unless appropriate “retain” directives are present in the IPA Link control file.
    - c. IPA Link may expose existing problems in the program:
      - Ensure that any coalesced global variables which are character strings have sufficient space to contain all characters plus an additional byte for the terminating null.
      - Ensure that there are no dependencies on the order in which data items or subprograms (functions, C++ methods) are generated.

- d. Do the following to check for a code generation problem:
- Specify a different OPT level during IPA Link processing. If the program executes correctly, contact IBM service and be prepared to supply the relevant source (PPONLY) and object modules.
  - Specify the option NOOPT during IPA Link processing. If the program executes correctly, contact IBM service and be prepared to supply the relevant source (PPONLY) and object modules.

If the program executes correctly at a different OPT level or NOOPT, perform a binary search for the IPA object file which contains the function for which code is incorrectly generated. Contact IBM service and be prepared to supply the relevant source (PPONLY) and object modules.

- e. Do the following to check for an IPA optimization problem:
- Specify NOINLINE IPA(LEVEL(1)) during IPA Link processing.  
If the program executes correctly, perform a binary search using INLINE IPA(LEVEL(1)) for the IPA object file which contains the function which is incorrectly optimized. Once you have located the IPA object file with the problem, use `noinline` directives within the IPA Link control file to determine the functions that are not correctly inlined. Contact IBM service and be prepared to supply the relevant source (PPONLY) and object modules and the IPA Link control file.  
Functions that are inconsistently prototyped may cause problems of this type. Verify that all interfaces are consistent and complete.
  - Specify IPA(LEVEL(0)) during IPA Link processing.  
If the program executes correctly, perform a binary search using INLINE IPA(LEVEL(1)) for the IPA object file which contains the function which is incorrectly optimized. Contact IBM service and be prepared to supply the relevant source (PPONLY) and object modules.
  - Specify IPA(LEVEL(1)) instead of IPA(LEVEL(2))  
If you are linking with IPA Level 2, try linking with Level 1.

---

At this point, if you still encounter problems that you think are the result of the compilation, contact IBM support.

---

## Steps for avoiding installation problems

Perform the following steps to avoid or solve most installation problems:

1. Review the step-by-step installation procedure that is documented in the z/OS Program Directory that is applicable to your environment.
2. Consult the PSP bucket as described on page 596.

---

If you still cannot solve the problem, contact your IBM Support Center.

You may need to reinstall the z/OS XL C/C++ product by using the procedure that is documented in the z/OS Program Directory. This procedure is tested for each product release and successfully installs the product.





## Appendix D. Calling the z/OS XL C/C++ compiler from assembler

To invoke the compiler dynamically under z/OS, you can use macro instructions such as ATTACH, LINK, or CALL in an assembler language program. For complete information on these macro instructions, refer to the list of manuals in *z/OS Information Roadmap*.

The following is the syntax of each macro instruction:

where:

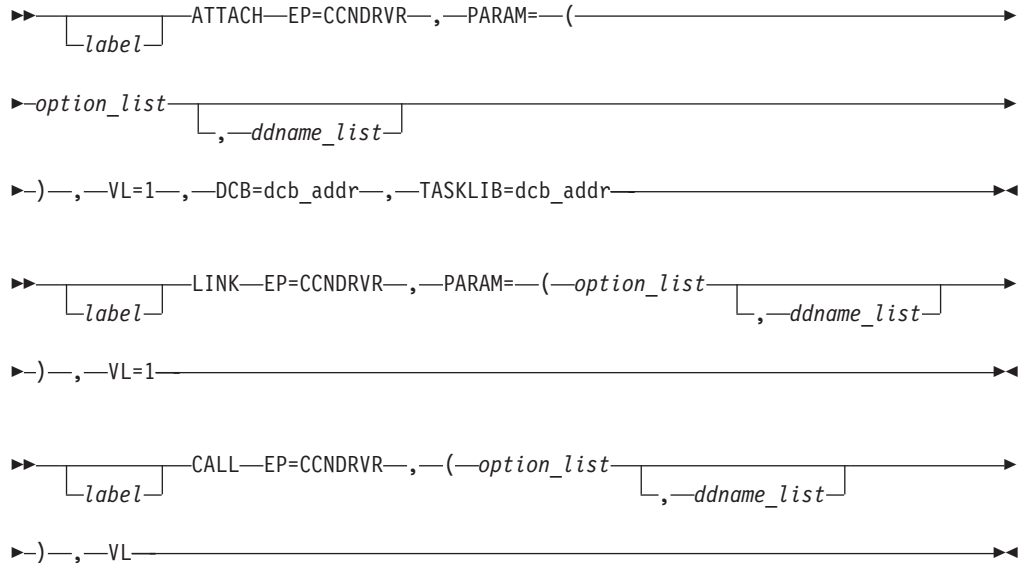

**EP** Specifies the symbolic name of the z/OS XL C/C++ compiler CCNDRVR. The control program determines the entry point at which execution is to begin.

**PARAM** Specifies a list that contains the addresses of the parameters to be passed to the z/OS XL C/C++ compiler

**option\_list** Specifies the address of a list that contains the options that you want to use for the compilation.

The *option\_list* must begin on a halfword boundary. The first 2 bytes must contain a count of the number of bytes in the remainder of the list. You specify the options in the same manner as you would on a JCL job, with spaces between options. If you do not want to specify any options, the count must be zero.

For C++ compiler invocation, you must include the characters CXX, and a blank before the list of compiler options. The number of bytes therefore should be 4 bytes longer.

**ddname\_list** Specifies the address of a list that contains alternative ddnames for the data sets that are used during the compiler processing. If you use standard ddnames, you can omit this parameter.

The *ddname\_list* must begin on a halfword boundary. The first two bytes must contain a count of the number of bytes in the remainder of the list. You must left-justify each name in the list, and pad it with blanks to a length of 8 bytes.

The sequence of ddnames in the list is:

- SYSIN
- SYSLIN
- SYSMGS - this ddname is no longer used, but is kept in the list for compatibility with old assembler macros.
- SYSLIB
- USERLIB
- SYSPRINT
- SYSCPRT
- SYSPUNCH
- SYSUT1
- SYSUT4
- SYSUT5
- SYSUT6
- SYSUT7
- SYSUT8
- SYSUT9
- SYSUT10
- SYSUT14
- SYSUT15
- SYSUT16
- SYSUT17
- SYSEVENT
- TEMPINC

You can omit an alternative ddname from the list by entering binary zeros in its 8-byte entry, or if it is at the end of the list, by shortening the list. If you omit a ddname, the compiler will use the appropriate default ddname from the above list.

|                   |   |
|-------------------|---|
| <b>VL or VL=1</b> | Specifies that the sign bit is to be set to 1 in the last fullword of the address parameter.        |
| <b>DCB</b>        | Specifies the address of the control block for the partitioned data set that contains the compiler. |
| <b>TASKLIB</b>    | Specifies the address of the DCB for the library that is to be used as the attached tasks library.  |

The return code from the compiler is returned in register 15.

If you code the macro instructions incorrectly, the compiler is not invoked, and the return code is 32. This error could be caused if the count of bytes in the alternative ddnames list is not a multiple of 8, or is not between 0 to 128.

If you specify an alternative ddname for SYSPRINT, the stdout stream is redirected to refer to the alternate ddname.

The following examples show the use of three assembler macros that rename ddnames completely or partially. Following each macro is the JCL that is used to invoke it.

---

## Example of using the assembler ATTACH macro (CCNUAAP)

```
*****
*
* This assembler routine demonstrates DD Name renaming
* (Dynamic compilation) using the Assembler ATTACH macro.
*
* In this specific scenario all the DDNAMES are renamed.
*
* The TASKLIB option of the ATTACH macro is used
* to specify the steplib for the ATTACHed command (ie. the compiler)
*
* The Compiler and Library should be specified on the DD
* referred to in the DCB for the TASKLIB if one or both
* are not already defined in LPA. The compiler and library do not
* need to be part of the steplib concatenation.
*
*****
ATTACH CSECT
      STM 14,12,12(13)
      BALR 3,0
      USING *,3
      LR 12,15
      ST 13,SAVE+4
      LA 15,SAVE
      ST 15,8(,13)
      LR 13,15
*
* Invoke the compiler using ATTACH macro
*
      OPEN (COMPILER)
      ATTACH EP=CCNDRVR,PARAM=(OPTIONS,DDNAMES),VL=1,DCB=COMPILER, X
            ECB=ECBADDR,TASKLIB=COMPILER
      ST 1,TCBADDR
      WAIT 1,ECB=ECBADDR
      DETACH TCBADDR
      CLOSE (COMPILER)
      L 13,4(,13)
      LM 14,12,12(13)
      SR 15,15
      BR 14
*
* Constant and save area
*
      SAVE DC 18F'0'
      ECBADDR DC F'0'
      TCBADDR DC F'0'
      OPTIONS DC H'12',C'SOURCE EVENT'
```

Figure 60. Using the assembler ATTACH Macro (Part 1 of 2)

```

*   For C++, substitute the above line with
*   OPTIONS DC   H'10',C'CXX SOURCE'

DDNAMES DC   H'152'
        DC   CL8'NEWIN'
        DC   CL8'NEWLIN'
        DC   CL8'DUMMY'    PLACEHOLDER - NO LONGER USED
        DC   CL8'NEWLIB'
        DC   CL8'NEWRLIB'
        DC   CL8'NEWPRINT'
        DC   CL8'NEWCPRT'
        DC   CL8'NEWPUNCH'
        DC   CL8'NEWUT1'
        DC   CL8'NEWUT4'
        DC   CL8'NEWUT5'
        DC   CL8'NEWUT6'
        DC   CL8'NEWUT7'
        DC   CL8'NEWUT8'
        DC   CL8'NEWUT9'
        DC   CL8'NEWUT10'
        DC   CL8'NEWUT14'
        DC   CL8'NEWUT15'
        DC   CL8'NEWEVENT'
COMPILER DCB DDNAME=MYCOMP,DSORG=PO,MACRF=R
        END

```

*Figure 60. Using the assembler ATTACH Macro (Part 2 of 2)*

---

## Example of JCL for the assembler ATTACH macro (CCNUAAQ)

```
/*-----  
/* Standard DDname Renaming (ASM ATTACH from driver program)  
/*   compiles           MYID.MYPROG.SOURCE(HELLO)  
/*   and places the object in MYID.MYPROG.OBJECT(HELLO)  
/*  
/*   User header files come from MYID.MYHDR.FILES  
/*   using MYCOMP as the compile time steplib.  
/*  
/*   Compilation is controlled by the assembler module named  
/*   CCNUAAP which is stored in MYID.ATTACHDD.LOAD  
/*  
/*   This example uses the Language Environment Library  
/*-----  
//G001001B EXEC PGM=CCNUAAP  
//STEPLIB DD DSN=MYID.ATTACHDD.LOAD,DISP=SHR  
//MYCOMP DD DSN=CBC.SCCNCMP,DISP=SHR  
// DD DSN=CEE.SCEERUN,DISP=SHR  
// DD DSN=CEE.SCEERUN2,DISP=SHR  
//NEWIN DD DSN=MYID.MYPROG.SOURCE(HELLO),DISP=SHR  
//NEWLIB DD DSN=CEE.SCEEH.H,DISP=SHR  
//NEWLIN DD DSN=MYID.MYPROG.OBJECT(HELLO),DISP=SHR  
//NEWPRINT DD SYSOUT=*  
//NEWCPRT DD SYSOUT=*,DCB=(RECFM=VBA,LRECL=137,BLKSIZE=882)  
//NEWPUNCH DD DSN=...  
//SYSTEM DD DUMMY  
//NEWUT1 DD DSN=...  
//NEWUT4 DD DSN=...  
//NEWUT5 DD DSN=...  
//NEWUT6 DD DSN=...  
//NEWUT7 DD DSN=...  
//NEWUT8 DD DSN=...  
//NEWUT9 DD DSN=...  
//NEWUT10 DD SYSOUT=*  
//NEWUT14 DD DSN=...  
//NEWUT15 DD DSN=...  
//NEWEVENT DD DSN=...  
//NEWRLIB DD DSN=MYID.MYHDR.FILES,DISP=SHR  
/*-----
```

Figure 61. JCL for the assembler ATTACH macro

Note that the sharing of resources between attached programs is not supported.

---

## Example of using the assembler LINK macro (CCNUAAR)

```
*****
*
* This assembler routine demonstrates DD Name renaming
* (Dynamic compilation) using the assembler LINK macro.
*
* In this specific scenario a subset of all the DDNAMES are
* renamed. The DDNAMES you do not want to rename are set to zero.
*
* The Compiler and the Library should be in the LPA, or should
* be specified on the STEPLIB DD in your JCL
*
*****
*
LINK      CSECT
          STM 14,12,12(13)
          BALR 3,0
          USING *,3
          LR 12,15
          ST 13,SAVE+4
          LA 15,SAVE
          ST 15,8(,13)
          LR 13,15
*
* Invoke the compiler using LINK macro
*
          LINK EP=CCNDRVR,PARAM=(OPTIONS,DDNAMES),VL=1
          L 13,4(,13)
          LM 14,12,12(13)
          SR 15,15
          BR 14
```

Figure 62. Using the assembler LINK macro (Part 1 of 2)



---

## Example of JCL for the assembler LINK macro (CCNUAAS)

```
/*-----  
/* Standard DDname Renaming using the assembler LINK macro  
/*   compiles           MYID.MYPROG.SOURCE(HELLO)  
/*   and places the object in MYID.MYPROG.OBJECT(HELLO)  
/*  
/*   User header files come from MYID.MYHDR.FILES  
/*  
/*   Compilation is controlled by the assembler module named  
/*   CCNUAAR that is stored in MYID.LINKDD.LOAD  
/*  
/*   This JCL uses the Language Environment Library.  
/*  
/*-----  
//G001003A EXEC PGM=CCNUAAR  
//STEPLIB DD DSN=CBC.SCCNCMP,DISP=SHR  
//        DD DSN=CEE.SCEERUN,DISP=SHR  
//        DD DSN=CEE.SCEERUN2,DISP=SHR  
//        DD DSN=MYID.LINKDD.LOAD,DISP=SHR  
//NEWIN DD DSN=MYID.MYPROG.SOURCE(HELLO),DISP=SHR  
//SYSLIB DD DSN=CEE.SCEEH.H,DISP=SHR  
//SYSLIN DD DSN=MYID.MYPROG.OBJECT(HELLO),DISP=SHR  
//SYSPRINT DD SYSOUT=*  
//NEWCPRT DD SYSOUT=*,DCB=(RECFM=VBA,LRECL=137,BLKSIZE=882)  
//SYSPUNCH DD SYSOUT=*  
//SYSTEM DD DUMMY  
//SYSUT1 DD DSN=...  
//SYSUT5 DD DSN=...  
//SYSUT6 DD DSN=...  
//SYSUT7 DD DSN=...  
//SYSUT8 DD DSN=...  
//SYSUT9 DD DSN=...  
//SYSUT10 DD SYSOUT=*  
//SYSUT14 DD DSN=...  
//SYSEVENT DD DSN=...  
//NEWRLIB DD DSN=MYID.MYHDR.FILES,DISP=SHR  
/*-----
```

Figure 63. JCL for the assembler LINK macro



---

## Example of using the assembler CALL macro (CCNUAAT)

```
*****
*
* This assembler routine demonstrates DD Name renaming
* (Dynamic compilation) using the Assembler CALL macro.
*
* In this specific scenario, a subset of all the DDNAMES are
* renamed. This renaming is accomplished by shortening
* the list of ddnames.
*
* The Compiler and the Library should be either be in the LPA or
* be specified on the STEPLIB DD in your JCL
*
*****
*
LINK      CSECT
          STM 14,12,12(13)
          USING LINK,15
          LA 3,MODE31
          O 3,=X'80000000'
          DC X'0B03'
MODE31    DS 0H
          USING *,3
          LR 12,15
          ST 13,SAVE+4
          LA 15,SAVE
          ST 15,8(,13)
          LR 13,15
*
* Invoke the compiler using CALL macro
*
          LOAD EP=CCNDRVR
          LR 15,0
          CALL (15),(OPTIONS,DDNAMES),VL
          L 13,4(,13)
          LM 14,12,12(13)
          SR 15,15
          BR 14
```

Figure 64. Using the assembler CALL macro (Part 1 of 2)

```

*
*   Constant and save area
*
SAVE      DC    18F'0'
OPTIONS   DC    H'2',C'SO'
*   For C++, substitute the above line with
*   OPTIONS   DC    H'6',C'CXX SO'
DDNAMES   DC    H'96'
          DC    CL8'NEWIN'
          DC    CL8'NEWLIN'
          DC    CL8'DUMMY'           PLACEHOLDER - NO LONGER USED
          DC    CL8'NEWLIB'
          DC    CL8'NEWRLIB'
          DC    CL8'NEWPRINT'
          DC    CL8'NEWCPRT'
          DC    CL8'NEWPUNCH'
          DC    CL8'NEWUT1'
          DC    CL8'NEWUT4'
          DC    CL8'NEWUT5'
          DC    CL8'NEWUT6'
          END

```

Figure 64. Using the assembler CALL macro (Part 2 of 2)

---

## Example of JCL for assembler CALL macro (CCNUAAU)

```
/*-----  
/* Standard DDname Renaming using the assembler CALL macro  
/*   compiles           MYID.MYPROG.SOURCE(HELLO)  
/*   and places the object in MYID.MYPROG.OBJECT(HELLO)  
/*  
/*   User Header files come from MYID.MYHDR.FILES  
/*  
/*   Compilation is controlled by the assembler module named  
/*   CCNUAAT which is stored in MYID.CALLDD.LOAD  
/*  
/*   This JCL uses the Language Environment Library.  
/*  
/*-----  
//G001004C EXEC PGM=CCNUAAT  
//STEPLIB DD DSN=ABC.SCCNCMP,DISP=SHR  
// DD DSN=CEE.SCEERUN,DISP=SHR  
// DD DSN=CEE.SCEERUN2,DISP=SHR  
// DD DSN=MYID.CALLDD.LOAD,DISP=SHR  
//NEWIN DD DSN=MYID.MYPROG.SOURCE(HELLO),DISP=SHR  
//NEWLIB DD DSN=CEE.SCEEH.H,DISP=SHR  
//NEWLIN DD DSN=MYID.MYPROG.OBJECT(HELLO),DISP=SHR  
//NEWPRINT DD SYSOUT=*  
//NEWCPRT DD SYSOUT=*,DCB=(RECFM=VBA,LRECL=137,BLKSIZE=882)  
//NEWPUNCH DD DSN=...  
//SYSTEM DD DUMMY  
//NEWUT1 DD DSN=...  
//NEWUT4 DD DSN=...  
//NEWUT5 DD DSN=...  
//NEWUT6 DD DSN=...  
//SYSUT7 DD DSN=...  
//SYSUT8 DD DSN=...  
//SYSUT9 DD DSN=...  
//SYSUT10 DD SYSOUT=*  
//SYSUT14 DD DSN=...  
//NEWRLIB DD DSN=MYID.MYHDR.FILES,DISP=SHR  
/*-----
```

Figure 65. JCL for the assembler CALL macro



---

## Appendix E. Layout of the Events file

This appendix specifies the layout of the SYSEVENT file. SYSEVENT is an events file that contains error information and source file statistics. The SYSEVENT file is not the same as the binder Input Event Log. Use the EVENTS compiler option to produce the SYSEVENT file. For more information on the EVENTS compiler option, see “EVENTS | NOEVENTS” on page 101.

In the following example, the source file `simple.c` is compiled with the `EVENTS(USERID.LIST(EGEVENT))` compiler option. The file `err.h` is a header file that is included in `simple.c`. Figure 68 is the event file that is generated when `simple.c` is compiled.

```
1 #include "./err.h"
2 main() {
3     add some error messages;
4     return(0);
5     here and there;
6 }
```

Figure 66. `simple.c`

```
1 add some;
2 errors in the header file;
```

Figure 67. `err.h`

```
----- start simple.events -----
FILEID 0 1 0 10 ./simple.c
FILEID 0 2 1 9 ./err.h
ERROR 0 2 0 0 1 1 0 0 CCN1AAA E 12 48 Definition of function add require
FILEEND 0 2 2
ERROR 0 2 0 0 1 5 0 0 CCN1BBB E 12 35 Syntax error: possible missing '{'
ERROR 0 1 0 0 3 3 0 0 CCN1CCC E 12 26 Undeclared identifier add.
ERROR 0 1 0 0 5 8 0 0 CCN1DDD E 12 42 Syntax error: possible missing ';'
ERROR 0 1 0 0 5 3 0 0 CCN1EEE E 12 27 Undeclared identifier here.
FILEEND 0 1 6
----- end simple.events -----
```

Figure 68. Sample SYSEVENT file

There are three different record types generated in the event file:

- FILEID
- FILEEND
- ERROR

---

### Description of the FILEID field

The following is an example of the FILEID field from the sample SYSEVENT file that is shown in Figure 68. Table 49 describes the FILEID identifiers.

```
FILEID 0 1 0 10 ./simple.c
      A B C D E
```

Table 49. Explanation of the FILEID field layout

| Column | Identifier | Description                          |
|--------|------------|--------------------------------------|
| A      | Revision   | Revision number of the event record. |

Table 49. Explanation of the FILEID field layout (continued)

| Column | Identifier       | Description  |
|--------|------------------|--|
| B      | File number      | Increments starting with 1 for the primary file.   |
| C      | Line number      | The line number of the #include directive. For the primary source file, this value is 0. |
| D      | File name length | Length of file or data set.  |
| E      | File name        | String containing file/data set name.  |

## Description of the FILEEND field

The following is an example of the FILEEND field from the sample SYSEVENT file that is shown in Figure 68 on page 617. Table 50 describes the FILEEND identifiers.

```
FILEEND 0 1 6
        A B C
```

Table 50. Explanation of the FILEEND field layout

| Column | Identifier  | Description  |
|--------|-------------|--|
| A      | Revision    | Revision number of the event record                |
| B      | File number | File number that has been processed to end of file |
| C      | Expansion   | Total number of lines in the file                  |

## Description of the ERROR field

The following is an example of the ERROR field from the sample SYSEVENT file that is shown in Figure 68 on page 617. Table 51 describes the ERROR identifiers.

```
ERROR 0 1 0 0 3 3 0 0 CBCMMM E 12 26 Undeclared identifier add.
        A B C D E F G H I       J K L M
```

Table 51. Explanation of the ERROR field layout

| Column | Identifier  | Description  |
|--------|-------------|--|
| A      | Revision    | Revision number of the event record.   |
| B      | File number | Increments starting with 1 for the primary file.                             |
| C      | Reserved    | Do not build a dependency on this identifier. It is reserved for future use. |
| D      | Reserved    | Do not build a dependency on this identifier. It is reserved for future use. |

Table 51. Explanation of the ERROR field layout (continued)

| Column | Identifier                 | Description  |
|--------|----------------------------|--|
| E      | Starting line number       | The source line number for which the message was issued. A value of 0 indicates the message was not associated with a line number.                               |
| F      | Starting column number     | The column number or position within the source line for which the message was issued. A value of 0 indicates the message was not associated with a line number. |
| G      | Reserved                   | Do not build a dependency on this identifier. It is reserved for future use.   |
| H      | Reserved                   | Do not build a dependency on this identifier. It is reserved for future use.   |
| I      | Message identifier         | String Containing the message identifier.  |
| J      | Message severity character | I=Informational<br>W=Warning<br>E=Error<br>S=Severe<br>U=Unrecoverable   |
| K      | Message severity number    | Return code associated with the message.   |
| L      | Message length             | Length of message text.  |
| M      | Message text               | String containing message text.  |





---

## Appendix F. Customizing default options for z/OS XL C/C++ compiler

System programmers can customize the default options for the z/OS XL C/C++ compiler by modifying USERMODs and jobs. The USERMOD can then be applied by submitting the jobs, which are also provided. See the following table for information on the USERMODs and jobs that can be modified.

Table 52. z/OS XL C/C++ compiler USERMODs and jobs

| Element name         | USERMODS | Resides in           | Jobs to submit       |
|----------------------|----------|----------------------|----------------------|
| z/OS XL C compiler   | CCNEOPT  | CBC.SCCNJCL(CCNJOPT) | CBC.SCCNJCL(CCNJMOD) |
| z/OS XL C++ compiler | CCNEOPX  | CBC.SCCNJCL(CCNJOPX) | CBC.SCCNJCL(CCNJMOX) |

For the z/OS XL C compiler, the USERMOD CCNEOPT modifies the CCNEO00C assembler source file, which defines the z/OS XL C compiler options. It also defines the system include file SEARCH path, which includes Language Environment header files.

For the z/OS XL C++ compiler, the USERMOD CCNEOPX modifies the CCNEO00X assembler source file, which defines the z/OS XL C++ compiler options. It also defines the system include file SEARCH path, which includes Language Environment header files.

If you plan to apply these USERMODs and have used a different prefix than the one supplied by IBM for the language environment and the Run-Time Library Extensions, please change the value of CEE and CBC to your chosen prefix on the SEARCH statements. Do not accept your USERMOD into the distribution library, as you might want to remove your USERMOD if you find it does not suit the needs of the programmers at your site.



---

## Appendix G. Accessibility

---

### Accessibility

Accessibility features help a user who has a physical disability, such as restricted mobility or limited vision, to use software products successfully. The major accessibility features in z/OS enable users to:

- Use assistive technologies such as screen readers and screen magnifier software
- Operate specific or equivalent features using only the keyboard
- Customize display attributes such as color, contrast, and font size

### Using assistive technologies

Assistive technology products, such as screen readers, function with the user interfaces found in z/OS. Consult the assistive technology documentation for specific information when using such products to access z/OS interfaces.

### Keyboard navigation of the user interface

Users can access z/OS user interfaces using TSO/E or ISPF. Refer to *z/OS TSO/E Primer*, *z/OS TSO/E User's Guide*, and *z/OS ISPF User's Guide Vol I* for information about accessing TSO/E and ISPF interfaces. These guides describe how to use TSO/E and ISPF, including the use of keyboard shortcuts or function keys (PF keys). Each guide includes the default settings for the PF keys and explains how to modify their functions.

### z/OS information

z/OS information is accessible using screen readers with the BookServer/Library Server versions of z/OS books in the Internet library at:

[www.ibm.com/servers/eserver/zseries/zos/bkserv/](http://www.ibm.com/servers/eserver/zseries/zos/bkserv/)



---

## Notices

This information was developed for products and services offered in the U.S.A.

IBM may not offer the products, services, or features discussed in this document in other countries. Consult your local IBM representative for information on the products and services currently available in your area. Any reference to an IBM product, program, or service is not intended to state or imply that only that IBM product, program, or service may be used. Any functionally equivalent product, program, or service that does not infringe any IBM intellectual property right may be used instead. However, it is the user's responsibility to evaluate and verify the operation of any non-IBM product, program, or service.

IBM may have patents or pending patent applications covering subject matter described in this document. The furnishing of this document does not give you any license to these patents. You can send license inquiries, in writing, to:

IBM Director of Licensing  
IBM Corporation  
North Castle Drive  
Armonk, NY 10504-1785  
U.S.A.

For license inquiries regarding double-byte (DBCS) information, contact the IBM Intellectual Property Department in your country or send inquiries, in writing, to:

IBM World Trade Asia Corporation  
Licensing  
2-31 Roppongi 3-chome, Minato-ku  
Tokyo 106-0032, Japan

**The following paragraph does not apply to the United Kingdom or any other country where such provisions are inconsistent with local law:**

INTERNATIONAL BUSINESS MACHINES CORPORATION PROVIDES THIS PUBLICATION "AS IS" WITHOUT WARRANTY OF ANY KIND, EITHER EXPRESS OR IMPLIED, INCLUDING, BUT NOT LIMITED TO, THE IMPLIED WARRANTIES OF NON-INFRINGEMENT, MERCHANTABILITY OR FITNESS FOR A PARTICULAR PURPOSE. Some states do not allow disclaimer of express or implied warranties in certain transactions, therefore, this statement may not apply to you.

This information could include technical inaccuracies or typographical errors. Changes are periodically made to the information herein; these changes will be incorporated in new editions of the publication. IBM may make improvements and/or changes in the product(s) and/or the program(s) described in this publication at any time without notice.

Any references in this information to non-IBM Web sites are provided for convenience only and do not in any manner serve as an endorsement of those Web sites. The materials at those Web sites are not part of the materials for this IBM product and use of those Web sites is at your own risk.

IBM may use or distribute any of the information you supply in any way it believes appropriate without incurring any obligation to you.

Licensees of this program who wish to have information about it for the purpose of enabling: (i) the exchange of information between independently created programs and other programs (including this one) and (ii) the mutual use of the information which has been exchanged, should contact:

Lab Director  
IBM Canada Ltd. Laboratory  
B3/KB7/8200/MKM  
8200 Warden Avenue  
Markham, Ontario L6G 1C7  
Canada

Such information may be available, subject to appropriate terms and conditions, including in some cases, payment of a fee.

The licensed program described in this information and all licensed material available for it are provided by IBM under terms of the IBM Customer Agreement, IBM International Program License Agreement, or any equivalent agreement between us.

This information contains examples of data and reports used in daily business operations. To illustrate them as completely as possible, the examples may include the names of individuals, companies, brands, and products. All of these names are fictitious and any similarity to the names and addresses used by an actual business enterprise is entirely coincidental.

#### COPYRIGHT LICENSE:

This information contains sample application programs in source language, which illustrates programming techniques on various operating platforms. You may copy, modify, and distribute these sample programs in any form without payment to IBM, for the purposes of developing, using, marketing or distributing application programs conforming to the application programming interface for the operating platform for which the sample programs are written. These examples have not been thoroughly tested under all conditions. IBM, therefore, cannot guarantee or imply reliability, serviceability, or function of these programs.

If you are viewing this information softcopy, the photographs and color illustrations may not appear.

---

## Programming interface information

This publication documents *intended* Programming Interfaces that allow the customer to write z/OS or z/OS.e XL C/C++ programs.

---

## Trademarks

The following terms are trademarks or registered trademarks of International Business Machines Corporation in the United States or other countries or both:

|          |             |                        |
|----------|-------------|------------------------|
| AIX      | BookManager | BookMaster             |
| C/370    | C/MVS       | CICS                   |
| CICS/ESA | DB2         | DB2 Universal Database |
| DFSMSdfp | DRDA        | eServer                |
| GDDM     | Hiperspace  | IBM                    |
| IMS      | IMS/ESA     | Language Environment   |
| MVS      | MVS/ESA     | Open Class             |

|           |         |                |
|-----------|---------|----------------|
| OS/2      | OS/390  | OS/400         |
| QMF       | S/370   | System z       |
| System z9 | VSE/ESA | z/Architecture |
| z/OS      | zSeries | z/VM           |

Microsoft and Windows are trademarks of Microsoft Corporation in the United States and/or other countries.

UNIX is a registered trademark of The Open Group in the United States and other countries.

Java and all Java-based trademarks are trademarks of Sun Microsystems, Inc. in the United States and/or other countries.

Linux is a trademark of Linus Torvalds in the United States, other countries, or both.

Other company, product, and service names may be trademarks or service marks of others.

---

## Standards

The following standards are supported in combination with z/OS Language Environment:

- The C language is consistent with *Programming languages - C (ISO/IEC 9899:1999)*. For more information on ISO, visit their web site at: [www.iso.org](http://www.iso.org)
- The C++ language is consistent with *Programming languages - C++ (ISO/IEC 14882:2003(E))* and *Programming languages - C++ (ISO/IEC 14882:1998)*.

The following standards are supported in combination with z/OS Language Environment and z/OS UNIX System Services:

- *IEEE Std 1003.1—1990, IEEE Standard Information Technology—Portable Operating System Interface (POSIX)—Part 1: System Application Program Interface (API) [C language]*, copyright 1990 by the Institute of Electrical and Electronic Engineers, Inc. For more information on IEEE, visit their web site at: [www.ieee.org](http://www.ieee.org)
- A subset of *IEEE P1003.1a Draft 6 July 1991, Draft Revision to Information Technology—Portable Operating System Interface (POSIX), Part 1: System Application Program Interface (API) [C Language]*, copyright 1992 by the Institute of Electrical and Electronic Engineers, Inc.
- *IEEE Std 1003.2—1992, IEEE Standard Information Technology—Portable Operating System Interface (POSIX)—Part 2: Shells and Utilities*, copyright 1990 by the Institute of Electrical and Electronic Engineers, Inc.
- A subset of *IEEE Std P1003.4a/D6—1992, IEEE Draft Standard Information Technology—Portable Operating System Interface (POSIX)—Part 1: System Application Program Interface (API)—Amendment 2: Threads Extension [C language]*, copyright 1990 by the Institute of Electrical and Electronic Engineers, Inc.
- A subset of *IEEE 754-1985 (R1990) IEEE Standard for Binary Floating-Point Arithmetic (ANSI)*, copyright 1985 by the Institute of Electrical and Electronic Engineers, Inc.
- *X/Open CAE Specification, System Interfaces and Headers, Issue 4 Version 2*, copyright 1994 by The Open Group

- *X/Open CAE Specification, Networking Services, Issue 4*, copyright 1994 by The Open Group
- *X/Open Specification Programming Languages, Issue 3, Common Usage C*, copyright 1988, 1989, and 1992 by The Open Group
- United States Government's *Federal Information Processing Standard (FIPS) publication for the programming language C, FIPS-160*, issued by National Institute of Standards and Technology, 1991



---

# Glossary

This glossary defines technical terms and abbreviations that are used in z/OS XL C/C++ documentation. If you do not find the term you are looking for, refer to the index of the appropriate z/OS XL C/C++ manual or view *IBM Glossary of Computing Terms*, located at: [www.ibm.com/ibm/terminology](http://www.ibm.com/ibm/terminology). This glossary includes terms and definitions from:

- *American National Standard Dictionary for Information Systems*, ANSI/ISO X3.172-1990, copyright 1990 by the American National Standards Institute (ANSI/ISO). Copies may be purchased from the American National Standards Institute, 11 West 42nd Street, New York, New York 10036. Definitions are indicated by the symbol *ANSI/ISO* after the definition.
- *IBM Dictionary of Computing*, SC20-1699. These definitions are indicated by the registered trademark *IBM* after the definition.
- *X/Open CAE Specification, Commands and Utilities, Issue 4, July, 1992*. These definitions are indicated by the symbol *X/Open* after the definition.
- *ISO/IEC 9945-1:1990/IEEE POSIX 1003.1-1990*. These definitions are indicated by the symbol *ISO.1* after the definition.
- *The Information Technology Vocabulary*, developed by Subcommittee 1, Joint Technical Committee 1, of the International Organization for Standardization and the International Electrotechnical Commission (ISO/IEC JTC1/SC1). Definitions of published parts of this vocabulary are identified by the symbol *ISO-JTC1* after the definition; definitions taken from draft international standards, committee drafts, and working papers being developed by ISO/IEC JTC1/SC1 are identified by the symbol *ISO Draft* after the definition, indicating that final agreement has not yet been reached among the participating National Bodies of SC1.

## A

**abstract class.** (1) A class with at least one pure virtual function that is used as a base class for other classes. The abstract class represents a concept; classes derived from it represent implementations of the concept. You cannot create a direct object of an abstract class, but you can create references and pointers to an abstract class and set them to refer to objects of classes derived from the abstract class. See also *base class*. (2) A class that allows polymorphism.

There can be no objects of an abstract class; they are only used to derive new classes.

**abstract code unit.** See *ACU*.

**abstract data type.** A mathematical model that includes a structure for storing data and operations that can be performed on that data. Common abstract data types include sets, trees, and heaps.

**abstraction (data).** A data type with a private representation and a public set of operations (functions or operators) which restrict access to that data type to that set of operations. The C++ language uses the concept of classes to implement data abstraction.

**access.** An attribute that determines whether or not a class member is accessible in an expression or declaration.

**access declaration.** A declaration used to restore access to members of a base class.

**access mode.** (1) A technique that is used to obtain a particular logical record from, or to place a particular logical record into, a file assigned to a mass storage device. *ANSI/ISO*. (2) The manner in which files are referred to by a computer. Access can be sequential (records are referred to one after another in the order in which they appear on the file), access can be random (the individual records can be referred to in a nonsequential manner), or access can be dynamic (records can be accessed sequentially or randomly, depending on the form of the input/output request). *IBM*. (3) A particular form of access permitted to a file. *X/Open*.

**access resolution.** The process by which the accessibility of a particular class member is determined.

**access specifier.** One of the C++ keywords: *public*, *private*, and *protected*, used to define the access to a member.

**ACU (abstract code unit).** A measurement used by the z/OS XL C/C++ compiler for judging the size of a function. The number of ACUs that comprise a function is proportional to its size and complexity.

**addressing mode.** See *AMODE*.

**address space.** (1) The range of addresses available to a computer program. *ANSI/ISO*. (2) The complete range of addresses that are available to a programmer. See also *virtual address space*. (3) The area of virtual storage available for a particular job. (4) The memory locations that can be referenced by a process. *X/Open*. *ISO.1*.

**aggregate.** (1) An array or a structure. (2) A compile-time option to show the layout of a structure or union in the listing. (3) In programming languages, a structured collection of data items that form a data type. *ISO-JTC1*. (4) In C++, an array or a class with no user-declared constructors, no private or protected non-static data members, no base classes, and no virtual functions.

**alert.** (1) A message sent to a management services focal point in a network to identify a problem or an impending problem. *IBM*. (2) To cause the user's terminal to give some audible or visual indication that an error or some other event has occurred. When the standard output is directed to a terminal device, the method for alerting the terminal user is unspecified. When the standard output is not directed to a terminal device, the alert is accomplished by writing the alert character to standard output (unless the utility description indicates that the use of standard output produces undefined results in this case). *X/Open*.

**alert character.** A character that in the output stream should cause a terminal to alert its user via a visual or audible notification. The alert character is the character designated by a '\a' in the C and C++ languages. It is unspecified whether this character is the exact sequence transmitted to an output device by the system to accomplish the alert function. *X/Open*.

This character is named <alert> in the portable character set.

**alias.** (1) An alternate label; for example, a label and one or more aliases may be used to refer to the same data element or point in a computer program. *ANSI/ISO*. (2) An alternate name for a member of a partitioned data set. *IBM*. (3) An alternate name used for a network. Synonymous with nickname. *IBM*.

**alias name.** (1) A word consisting solely of underscores, digits, and alphabetic characters from the portable file name character set, and any of the following characters: ! % , @. Implementations may allow other characters within alias names as an extension. *X/Open*. (2) An alternate name. *IBM*. (3) A name that is defined in one network to represent a logical unit name in another interconnected network. The alias name does not have to be the same as the real name; if these names are not the same; translation is required. *IBM*.

**alignment.** The storing of data in relation to certain machine-dependent boundaries. *IBM*.

**alternate code point.** A syntactic code point that permits a substitute code point to be used. For example, the left brace ( { ) can be represented by X'B0' and also by X'CO'.

**American National Standard Code for Information Interchange (ASCII).** The standard code, using a coded character set consisting of 7-bit coded characters (8 bits including parity check), that is used for

information interchange among data processing systems, data communication systems, and associated equipment. The ASCII set consists of control characters and graphic characters. *IBM*.

**Note:** IBM has defined an extension to ASCII code (characters 128–255).

**American National Standards Institute (ANSI/ISO).** An organization consisting of producers, consumers, and general interest groups, that establishes the procedures by which accredited organizations create and maintain voluntary industry standards in the United States. *ANSI/ISO*.

**AMODE (addressing mode).** In z/OS, a program attribute that refers to the address length that a program is prepared to handle upon entry. In z/OS, addresses may be 24, 31, or 64 bits in length. *IBM*.

**angle brackets.** The characters < (left angle bracket) and > (right angle bracket). When used in the phrase "enclosed in angle brackets", the symbol < immediately precedes the object to be enclosed, and > immediately follows it. When describing these characters in the portable character set, the names <less-than-sign> and <greater-than-sign> are used. *X/Open*.

**anonymous union.** A union that is declared within a structure or class and does not have a name. It must not be followed by a declarator.

**ANSI/ISO.** See *American National Standards Institute*.

**API (application program interface).** A functional interface supplied by the operating system or by a separately orderable licensed program that allows an application program written in a high-level language to use specific data or functions of the operating system or the licensed program. *IBM*.

**application.** (1) The use to which an information processing system is put; for example, a payroll application, an airline reservation application, a network application. *IBM*. (2) A collection of software components used to perform specific types of user-oriented work on a computer. *IBM*.

**application generator.** An application development tool that creates applications, application components (panels, data, databases, logic, interfaces to system services), or complete application systems from design specifications.

**application program.** A program written for or by a user that applies to the user's work, such as a program that does inventory control or payroll. *IBM*.

**archive libraries.** The archive library file, when created for application program object files, has a special symbol table for members that are object files.

**argument.** (1) A parameter passed between a calling program and a called program. *IBM.* (2) In a function call, an expression that represents a value that the calling function passes to the function specified in the call. (3) In the shell, a parameter passed to a utility as the equivalent of a single string in the *argv* array created by one of the *exec* functions. An argument is one of the options, option-arguments, or operands following the command name. *X/Open.*

**argument declaration.** See *parameter declaration.*

**arithmetic object.** (1) A bit field, or an integral, floating-point, or packed decimal (IBM extension) object. (2) A real object or objects having the type float, double, or long double.

**array.** In programming languages, an aggregate that consists of data objects with identical attributes, each of which may be uniquely referenced by subscripting. *ISO-JTC1.*

**array element.** A data item in an array. *IBM.*

**ASCII.** See *American National Standard Code for Information Interchange.*

**Assembler H.** An IBM licensed program. Translates symbolic assembler language into binary machine language.

**assembler language.** A source language that includes symbolic language statements in which there is a one-to-one correspondence with the instruction formats and data formats of the computer. *IBM.*

**assembler user exit.** In z/OS Language Environment a routine to tailor the characteristics of an enclave prior to its establishment.

**assignment expression.** An expression that assigns the value of the right operand expression to the left operand variable and has as its value the value of the right operand. *IBM.*

**atexit list.** A list of actions specified in the z/OS XL C/C++ *atexit()* function that occur at normal program termination.

**auto storage class specifier.** A specifier that enables the programmer to define a variable with automatic storage; its scope restricted to the current block.

**automatic call library.** Contains modules that are used as secondary input to the binder to resolve external symbols left undefined after all the primary input has been processed.

The automatic call library can contain:

- Object modules, with or without binder control statements
- Load modules
- z/OS XL C/C++ run-time routines (SCEELKED)

**automatic library call.** The process in which control sections are processed by the binder or loader to resolve references to members of partitioned data sets. *IBM.*

**automatic storage.** Storage that is allocated on entry to a routine or block and is freed on the subsequent return. Sometimes referred to as *stack storage* or *dynamic storage.*

## B

**background process.** (1) A process that does not require operator intervention but can be run by the computer while the workstation is used to do other work. *IBM.* (2) A mode of program execution in which the shell does not wait for program completion before prompting the user for another command. *IBM.* (3) A process that is a member of a background process group. *X/Open. ISO.1.*

**background process group.** Any process group, other than a foreground process group, that is a member of a session that has established a connection with a controlling terminal. *X/Open. ISO.1.*

**backslash.** The character \. This character is named <backslash> in the portable character set.

**base class.** A class from which other classes are derived. A base class may itself be derived from another base class. See also *abstract class.*

**based on.** The use of existing classes for implementing new classes.

**binary expression.** An expression containing two operands and one operator.

**binary stream.** (1) An ordered sequence of untranslated characters. (2) A sequence of characters that corresponds on a one-to-one basis with the characters in the file. No character translation is performed on binary streams. *IBM.*

**bind.** (1) To combine one or more control sections or program modules into a single program module, resolving references between them. (2) To assign virtual storage addresses to external symbols.

**binder.** The DFSMS/MVS program that processes the output of language translators and compilers into an executable program (load module or program object). It replaces the linkage editor and batch loader in the MVS/ESA, OS/390, or z/OS operating system.

**bit field.** A member of a structure or union that contains a specified number of bits. *IBM.*

**bitwise operator.** An operator that manipulates the value of an object at the bit level.

**blank character.** (1) A graphic representation of the space character. *ANSI/ISO.* (2) A character that represents an empty position in a graphic character string. *ISO Draft.* (3) One of the characters that belong to the *blank* character class as defined via the `LC_CTYPE` category in the current locale. In the POSIX locale, a blank character is either a tab or a space character. *X/Open.*

**block.** (1) In programming languages, a compound statement that coincides with the scope of at least one of the declarations contained within it. A block may also specify storage allocation or segment programs for other purposes. *ISO-JTC1.* (2) A string of data elements recorded or transmitted as a unit. The elements may be characters, words or physical records. *ISO Draft.* (3) The unit of data transmitted to and from a device. Each block contains one record, part of a record, or several records.

**block statement.** In the C or C++ languages, a group of data definitions, declarations, and statements appearing between a left brace and a right brace that are processed as a unit. The block statement is considered to be a single C or C++ statement. *IBM.*

**boundary alignment.** The position in main storage of a fixed-length field, such as a halfword or doubleword, on a byte-level boundary for that unit of information. *IBM.*

**braces.** The characters { (left brace) and } (right brace), also known as *curly braces*. When used in the phrase “enclosed in (curly) braces” the symbol { immediately precedes the object to be enclosed, and } immediately follows it. When describing these characters in the portable character set, the names <left-brace> and <right-brace> are used. *X/Open.*

**brackets.** The characters [ (left bracket) and ] (right bracket), also known as *square brackets*. When used in the phrase *enclosed in (square) brackets* the symbol [ immediately precedes the object to be enclosed, and ] immediately follows it. When describing these characters in the portable character set, the names <left-bracket> and <right-bracket> are used. *X/Open.*

**break statement.** A C or C++ control statement that contains the keyword “break” and a semicolon. *IBM.* It is used to end an iterative or a switch statement by exiting from it at any point other than the logical end. Control is passed to the first statement after the iteration or switch statement.

**built-in.** (1) A function that the compiler will automatically inline instead of making the function call, unless the programmer specifies not to inline. (2) In programming languages, pertaining to a language object that is declared by the definition of the programming language; for example, the built-in function

`SIN` in PL/I, the predefined data type `INTEGER` in FORTRAN. *ISO-JTC1.* Synonymous with *predefined.* *IBM.*

**byte-oriented stream.** See *orientation of a stream.*

## C

**C library.** A system library that contains common C language subroutines for file access, string operators, character operations, memory allocation, and other functions. *IBM.*

**C or C++ language statement.** A C or C++ language statement contains zero or more expressions. A block statement begins with a { (left brace) symbol, ends with a } (right brace) symbol, and contains any number of statements.

All C or C++ language statements, except block statements, end with a ; (semicolon) symbol.

**c89 utility.** A utility used to compile and bind an application program from the z/OS shell. It invokes the compiler using host environment variables.

**C++ class library.** A collection of C++ classes.

**C++ library.** A system library that contains common C++ language subroutines for file access, memory allocation, and other functions.

**callable services.** A set of services that can be invoked by z/OS Language Environment-conforming high level languages using the conventional z/OS Language Environment-defined call interface, and usable by all programs sharing the z/OS Language Environment conventions.

Use of these services helps to decrease an application's dependence on the specific form and content of the services delivered by any single operating system.

**call chain.** A trace of all active functions.

**caller.** A function that calls another function.

**cancelability point.** A specific point within the current thread that is enabled to solicit cancel requests. This is accomplished using the `pthread_testintr()` function.

**carriage-return character.** A character that in the output stream indicates that printing should start at the beginning of the same physical line in which the carriage-return character occurred. The carriage-return is the character designated by ‘\r’ in the C and C++ languages. It is unspecified whether this character is the exact sequence transmitted to an output device by the system to accomplish the movement to the beginning of the line. *X/Open.*

**case clause.** In a C or C++ switch statement, a `CASE` label followed by any number of statements.



**case label.** The word case followed by a constant integral expression and a colon. When the selector evaluates the value of the constant expression, the statements following the case label are processed.

**cast expression.** An expression that converts or reinterprets its operand.

**cast operator.** The cast operator is used for explicit type conversions.

**cataloged procedures.** A set of control statements placed in a library and retrievable by name. *IBM.*

**catch block.** A block associated with a try block that receives control when an exception matching its argument is thrown.

**char specifier.** A char is a built-in data type. In the C++ language, char, signed char, and unsigned char are all distinct data types.

**character.** (1) A letter, digit, or other symbol that is used as part of the organization, control, or representation of data. A character is often in the form of a spatial arrangement of adjacent or connected strokes. *ANSI/ISO.* (2) A sequence of one or more bytes representing a single graphic symbol or control code. This term corresponds to the ISO C standard term *multibyte character* (multibyte character), where a single-byte character is a special case of the multibyte character. Unlike the usage in the ISO C standard, *character* here has no necessary relationship with storage space, and *byte* is used when storage space is discussed. *X/Open. ISO.1.*

**character array.** An array of type char. *X/Open.*

**character class.** A named set of characters sharing an attribute associated with the name of the class. The classes and the characters that they contain are dependent on the value of the LC\_CTYPE category in the current locale. *X/Open.*

**character constant.** A string of any of the characters that can be represented, usually enclosed in quotes.

**character set.** (1) A finite set of different characters that is complete for a given purpose; for example, the character set in ISO Standard 646, 7-bit Coded Character Set for Information Processing Interchange. *ISO Draft.* (2) All the valid characters for a programming language or for a computer system. *IBM.* (3) A group of characters used for a specific reason; for example, the set of characters a printer can print. *IBM.* (4) See also *portable character set.*

**character special file.** (1) A special file that provides access to an input or output device. The character interface is used for devices that do not use block I/O. *IBM.* (2) A file that refers to a device. One specific type of character special file is a terminal device file. *X/Open. ISO.1.*

**character string.** A contiguous sequence of characters terminated by and including the first null byte. *X/Open.*

**child.** A node that is subordinate to another node in a tree structure. Only the root node is not a child.

**child enclave.** The *nested enclave* created as a result of certain commands being issued from a *parent enclave.*

**CICS (Customer Information Control System).** Pertaining to an IBM licensed program that enables transactions entered at remote terminals to be processed concurrently by user-written application programs. It includes facilities for building, using, and maintaining databases. *IBM.*

**CICS destination control table.** See *DCT.*

**CICS translator.** A routine that accepts as input an application containing EXEC CICS commands and produces as output an equivalent application in which each CICS command has been translated into the language of the source.

**class.** (1) A C++ aggregate that may contain functions, types, and user-defined operators in addition to data. A class may be derived from another class, inheriting the properties of its parent class. A class may restrict access to its members. (2) A user-defined data type. A class data type can contain both data representations (data members) and functions (member functions).

**class key.** One of the C++ keywords: class, struct and union.

**class library.** A collection of classes.

**class member operator.** An operator used to access class members through class objects or pointers to class objects. The class member operators are:

. -> .\* ->\*

**class name.** A unique identifier that names a class type.

**class scope.** An indication that a name of a class can be used only in a member function of that class.

**class tag.** Synonym for *class name.*

**class template.** A blueprint describing how a set of related classes can be constructed.

**class template declaration.** A class template declaration introduces the name of a class template and specifies its template parameter list. A class template declaration may optionally include a class template definition.

**class template definition.** A class template definition describes various characteristics of the class types that are its specializations. These characteristics include the

names and types of data members of specializations, the signatures and definitions of member functions, accessibility of members, and base classes.

**client program.** A program that uses a class. The program is said to be a *client* of the class.

**CLIST.** A programming language that typically executes a list of TSO commands.

**CLLE (COBOL Load List Entry).** Entry in the load list containing the name of the program and the load address.

**COBCOM.** Control block containing information about a COBOL partition.

**COBOL (common business-oriented language).** A high-level language, based on English, that is primarily used for business applications.

**COBOL Load List Entry.** See *CLLE*.

**COBVEC.** COBOL vector table containing the address of the library routines.

**code element set.** (1) The result of applying a code to all elements of a coded set, for example, all the three-letter international representations of airport names. *ISO Draft.* (2) The result of applying rules that map a numeric code value to each element of a character set. An element of a character set may be related to more than one numeric code value but the reverse is not true. However, for state-dependent encodings the relationship between numeric code values to elements of a character set may be further controlled by state information. The character set may contain fewer elements than the total number of possible numeric code values; that is, some code values may be unassigned. *X/Open.* (3) Synonym for codeset.

**code generator.** The part of the compiler that physically generates the object code.

**code page.** (1) An assignment of graphic characters and control function meanings to all code points; for example, assignment of characters and meanings to 256 code points for an 8-bit code, assignment of characters and meanings to 128 code points for a 7-bit code. (2) A particular assignment of hexadecimal identifiers to graphic characters.

**code point.** (1) A representation of a unique character. For example, in a single-byte character set each of 256 possible characters is represented by a one-byte code point. (2) An identifier in an alert description that represents a short unit of text. The code point is replaced with the text by an alert display program.

**coded character set.** (1) A set of graphic characters and their code point assignments. The set may contain fewer characters than the total number of possible

characters: some code points may be unassigned. *IBM.* (2) A coded set whose elements are single characters; for example, all characters of an alphabet. *ISO Draft.* (3) Loosely, a code. *ANSI/ISO.*

**codeset.** Synonym for code element set. *IBM.*

**collating element.** The smallest entity used to determine the logical ordering of character or wide-character strings. A collating element consists of either a single character, or two or more characters collating as a single entity. The value of the LC\_COLLATE category in the current locale determines the current set of collating elements. *X/Open.*

**collating sequence.** (1) A specified arrangement used in sequencing. *ISO-JTC1. ANSI/ISO.* (2) An ordering assigned to a set of items, such that any two sets in that assigned order can be collated. *ANSI/ISO.* (3) The relative ordering of collating elements as determined by the setting of the LC\_COLLATE category in the current locale. The character order, as defined for the LC\_COLLATE category in the current locale, defines the relative order of all collating elements, such that each element occupies a unique position in the order. This is the order used in ranges of characters and collating elements in regular expressions and pattern matching. In addition, the definition of the collating weights of characters and collating elements uses collating elements to represent their respective positions within the collation sequence.

**collation.** The logical ordering of character or wide-character strings according to defined precedence rules. These rules identify a collation sequence between the collating elements, and such additional rules that can be used to order strings consisting of multiple collating elements. *X/Open.*

**collection.** (1) An abstract class without any ordering, element properties, or key properties. (2) In a general sense, an implementation of an abstract data type for storing elements.

**Collection Class Library.** A set of classes that provide basic functions for collections, and can be used as base classes.

**column position.** A unit of horizontal measure related to characters in a line.

It is assumed that each character in a character set has an intrinsic column width independent of any output device. Each printable character in the portable character set has a column width of one. The standard utilities, when used as described in this document set, assume that all characters have integral column widths. The column width of a character is not necessarily related to the internal representation of the character (numbers of bits or bytes).

The column position of a character in a line is defined as one plus the sum of the column widths of the

preceding characters in the line. Column positions are numbered starting from 1. *X/Open*.

**comma expression.** An expression (not a function argument list) that contains two or more operands separated by commas. The compiler evaluates all operands in the order specified, discarding all but the last (rightmost). The value of the expression is the value of the rightmost operand. Typically this is done to produce side effects.

**command.** A request to perform an operation or run a program. When parameters, arguments, flags, or other operands are associated with a command, the resulting character string is a single command.

**command processor parameter list (CPPL).** The format of a TSO parameter list. When a TSO terminal monitor application attaches a command processor, register 1 contains a pointer to the CPPL, containing addresses required by the command processor.

**COMMAREA.** A communication area made available to applications running under CICS.

**Common Business-Oriented Language.** See *COBOL*.

**common expression elimination.** Duplicated expressions are eliminated by using the result of the previous expression. This includes intermediate expressions within expressions.

**compilation unit.** (1) A portion of a computer program sufficiently complete to be compiled correctly. *IBM*. (2) A single compiled file and all its associated include files. (3) An independently compilable sequence of high-level language statements. Each high-level language product has different rules for what makes up a compilation unit.

**complete class name.** The complete qualification of a nested class name including all enclosing class names.

**Complex Mathematics library.** A C++ class library that provides the facilities to manipulate complex numbers and perform standard mathematical operations on them.

**computational independence.** No data modified by either a main task program or a parallel function is examined or modified by a parallel function that might be running simultaneously.

**concrete class.** (1) A class that is not abstract. (2) A class defining objects that can be created.

**condition.** (1) A relational expression that can be evaluated to a value of either true or false. *IBM*. (2) An exception that has been enabled, or recognized, by the z/OS Language Environment and thus is eligible to activate user and language condition handlers. Any alteration to the normal programmed flow of an application. Conditions can be detected by the

hardware/operating system and result in an interrupt. They can also be detected by language-specific generated code or language library code.

**conditional expression.** A compound expression that contains a condition (the first expression), an expression to be evaluated if the condition has a nonzero value (the second expression), and an expression to be evaluated if the condition has the value zero (the third expression).

**condition handler.** A user-written condition handler or language-specific condition handler (such as a PL/I ON-unit or z/OS XL C/C++ `signal()` function call) invoked by the z/OS XL C/C++ *condition manager* to respond to conditions.

**condition manager.** Manages conditions in the common execution environment by invoking various user-written and language-specific *condition handlers*.

**condition token.** In z/OS Language Environment, a data type consisting of 12 bytes (96 bits). The condition token contains structured fields that indicate various aspects of a condition including the severity, the associated message number, and information that is specific to a given instance of the condition.

**const.** (1) An attribute of a data object that declares the object cannot be changed. (2) A keyword that allows you to define a variable whose value does not change. (3) A keyword that allows you to define a parameter that is not changed by the function. (4) A keyword that allows you to define a member function that does not modify the state of the class for which it is defined.

**constant.** (1) In programming languages, a language object that takes only one specific value. *ISO-JTC1*. (2) A data item with a value that does not change. *IBM*.

**constant expression.** An expression having a value that can be determined during compilation and that does not change during the running of the program. *IBM*.

**constant propagation.** An optimization technique where constants used in an expression are combined and new ones are generated. Mode conversions are done to allow some intrinsic functions to be evaluated at compile time.

**constructed reentrancy.** The attribute of applications that contain external data and require additional processing to make them reentrant. Contrast with *natural reentrancy*.

**constructor.** A special C++ class member function that has the same name as the class and is used to create an object of that class.

**control character.** (1) A character whose occurrence in a particular context specifies a control function. *ISO Draft*. (2) Synonymous with non-printing character. *IBM*.

(3) A character, other than a graphic character, that affects the recording, processing, transmission, or interpretation of text. *X/Open*.

**control statement.** (1) A statement that is used to alter the continuous sequential execution of statements; a control statement may be a conditional statement, such as *if*, or an imperative statement, such as *return*. (2) A statement that changes the path of execution.

**controlling process.** The session leader that establishes the connection to the controlling terminal. If the terminal ceases to be a controlling terminal for this session, the session leader ceases to be the controlling process. *X/Open*. *ISO.1*.

**controlling terminal.** A terminal that is associated with a session. Each session may have at most one controlling terminal associated with it, and a controlling terminal is associated with exactly one session. Certain input sequences from the controlling terminal cause signals to be sent to all processes in the process group associated with the controlling terminal. *X/Open*. *ISO.1*.

**conversion.** (1) In programming languages, the transformation between values that represent the same data item but belong to different data types. Information may be lost because of conversion since accuracy of data representation varies among different data types. *ISO-JTC1*. (2) The process of changing from one method of data processing to another or from one data processing system to another. *IBM*. (3) The process of changing from one form of representation to another; for example to change from decimal representation to binary representation. *IBM*. (4) A change in the type of a value. For example, when you add values having different data types, the compiler converts both values to a common form before adding the values.

**conversion descriptor.** A per-process unique value used to identify an open codeset conversion. *X/Open*.

**conversion function.** A member function that specifies a conversion from its class type to another type.

**coordinated universal time (UTC).** Synonym for Greenwich Mean Time (GMT). See *GMT*.

**copy constructor.** A constructor that copies a class object of the same class type.

**CSECT (control section).** The part of a program specified by the programmer to be a relocatable unit, all elements of which are to be loaded into adjoining main storage locations.

**Cross System Product.** See *CSP*.

**CSP (Cross System Product).** A set of licensed programs designed to permit the user to develop and run applications using independently defined maps (display and printer formats), data items (records,

working storage, files, and single items), and processes (logic). The Cross System Product set consists of two parts: Cross System Product/Application Development (CSP/AD) and Cross System Product/Application Execution (CSP/AE). *IBM*.

**current working directory.** (1) A directory, associated with a process, that is used in path name resolution for path names that do not begin with a slash. *X/Open*. *ISO.1*. (2) In the OS/2<sup>®</sup> operating system, the first directory in which the operating system looks for programs and files and stores temporary files and output. *IBM*. (3) In the z/OS UNIX System Services environment, a directory that is active and that can be displayed. Relative path name resolution begins in the current directory. *IBM*.

**cursor.** A reference to an element at a specific position in a data structure.

**Customer Information Control System.** See *CICS*.

## D

**data abstraction.** A data type with a private representation and a public set of operations (functions or operators) which restrict access to that data type to that set of operations. The C++ language uses the concept of classes to implement data abstraction.

**data definition (DD).** (1) In the C and C++ languages, a definition that describes a data object, reserves storage for a data object, and can provide an initial value for a data object. A data definition appears outside a function or at the beginning of a block statement. *IBM*. (2) A program statement that describes the features of, specifies relationships of, or establishes context of, data. *ANSI/ISO*. (3) A statement that is stored in the environment and that externally identifies a file and the attributes with which it should be opened.

**data definition name.** See *ddname*.

**data definition statement.** See *DD statement*.

**data member.** The smallest possible piece of complete data. Elements are composed of data members.

**data object.** (1) A storage area used to hold a value. (2) Anything that exists in storage and on which operations can be performed, such as files, programs, classes, or arrays. (3) In a program, an element of data structure, such as a file, array, or operand, that is needed for the execution of a program and that is named or otherwise specified by the allowable character set of the language in which a program is coded. *IBM*.

**data set.** Under z/OS, a named collection of related data records that is stored and retrieved by an assigned name.



**data stream.** A continuous stream of data elements being transmitted, or intended for transmission, in character or binary-digit form, using a defined format. *IBM.*

**data structure.** The internal data representation of an implementation.

**data type.** The properties and internal representation that characterize data.

**Data Window Services (DWS).** Services provided as part of the Callable Services Library that allow manipulation of data objects such as VSAM linear data sets and temporary data objects known as *TEMPSPACE*.

**DBCS (double-byte character set).** A set of characters in which each character is represented by 2 bytes. Languages such as Japanese, Chinese, and Korean, which contain more symbols than can be represented by 256 code points, require double-byte character sets.

Because each character requires 2 bytes, the typing, display, and printing of DBCS characters requires hardware and programs that support DBCS. *IBM.*

**DCT (destination control table).** A table that contains an entry for each extrapartition, intrapartition, and indirect destination. Extrapartition entries address data sets external to the CICS region. Intrapartition destination entries contain the information required to locate the queue in the intrapartition data set. Indirect destination entries contain the information required to locate the queue in the intrapartition data set.

**ddname (data definition name).** (1) The logical name of a file within an application. The ddname provides the means for the logical file to be connected to the physical file. (2) The part of the data definition before the equal sign. It is the name used in a call to *fopen* or *freopen* to refer to the data definition stored in the environment.

**DD statement (data definition statement).** (1) In z/OS, serves as the connection between the logical name of a file and the physical name of the file. (2) A job control statement that defines a file to the operating system, and is a request to the operating system for the allocation of input/output resources.

**dead code elimination.** A process that eliminates code that exists for calculations that are not necessary. Code may be designated as dead by other optimization techniques.

**dead store elimination.** A process that eliminates unnecessary storage use in code. A store is deemed unnecessary if the value stored is never referenced again in the code.

**decimal constant.** (1) A numerical data type used in standard arithmetic operations. (2) A number containing any of the digits 0 through 9. *IBM.*

**decimal overflow.** A condition that occurs when one or more nonzero digits are lost because the destination field in a decimal operation is too short to contain the results.

**declaration.** (1) In the C and C++ languages, a description that makes an external object or function available to a function or a block statement. *IBM.* (2) Establishes the names and characteristics of data objects and functions used in a program.

**declarator.** Designates a data object or function declared. Initializations can be performed in a declarator.

**default argument.** An argument that is declared with a default value in a function prototype or declaration. If a call to the function omits this argument, the default value is used. Arguments with default values must be the trailing arguments in a function prototype argument list.

**default clause.** In the C or C++ languages, within a switch statement, the keyword *default* followed by a colon, and one or more statements. When the conditions of the specified case labels in the switch statement do not hold, the default clause is chosen. *IBM.*

**default constructor.** A constructor that takes no arguments, or, if it takes arguments, all its arguments have default values.

**default initialization.** The initial value assigned to a data object by the compiler if no initial value is specified by the programmer.

**default locale.** (1) The C locale, which is always used when no selection of locale is performed. (2) A system default locale, named by locale-related environmental variables.

**define directive.** A preprocessor directive that directs the preprocessor to replace an identifier or macro invocation with special code.

**definition.** (1) A data description that reserves storage and may provide an initial value. (2) A declaration that allocates storage, and may initialize a data object or specify the body of a function.

**degree.** The number of children of a node.

**delete.** (1) A C++ keyword that identifies a free storage deallocation operator. (2) A C++ operator used to destroy objects created by *new*.

**demangling.** The conversion of mangled names back to their original source code names. During C++

compilation, identifiers such as function and static class member names are mangled (encoded) with type and scoping information to ensure type-safe linkage. These mangled names appear in the object file and the final executable file. Demangling (decoding) converts these names back to their original names to make program debugging easier. See also *mangling*.

**deque.** A queue that can have elements added and removed at both ends. A double-ended queue.

**dequeue.** An operation that removes the first element of a queue.

**dereference.** In the C and C++ languages, the application of the unary operator \* to a pointer to access the object the pointer points to. Also known as *indirection*.

**derivation.** In the C++ language, to derive a class, called a derived class, from an existing class, called a base class.

**derived class.** A class that inherits from a base class. All members of the base class become members of the derived class. You can add additional data members and member functions to the derived class. A derived class object can be manipulated as if it is a base class object. The derived class can override virtual functions of the base class.

**descriptor.** PL/I control block that holds information such as string lengths, array subscript bounds, and area sizes, and is passed from one PL/I routine to another during run time.

**destination control table.** See *DCT*.

**destructor.** A special member function that has the same name as its class, preceded by a tilde (~), and that "cleans up" after an object of that class, for example, freeing storage that was allocated when the object was created. A destructor has no arguments and no return type.

**detach state attribute.** An attribute associated with a thread attribute object. This attribute has two possible values:

- 0** Undetached. An undetached thread keeps its resources after termination of the thread.
- 1** Detached. A detached thread has its resources freed by the system after termination.

**device.** A computer peripheral or an object that appears to the application as such. *X/Open. ISO.1.*

**difference.** For two sets A and B, the difference (A-B) is the set of all elements in A but not in B. For bags, there is an additional rule for duplicates: If bag P contains an element *m* times and bag Q contains the same element *n* times, then, if  $m > n$ , the difference

contains that element  $m-n$  times. If  $m \leq n$ , the difference contains that element zero times.

**digraph.** A combination of two keystrokes used to represent unavailable characters in a C or C++ source program. Digraphs are read as tokens during the preprocessor phase.

**directory.** (1) In a hierarchical file system, a container for files or other directories. *IBM.* (2) The part of a partitioned data set that describes the members in the data set.

**disabled signal.** Synonym for *enabled signal*.

**display.** To direct the output to the user's terminal. If the output is not directed to the terminal, the results are undefined. *X/Open.*

**DLL.** See *dynamic link library*.

**do statement.** In the C and C++ compilers, a looping statement that contains the keyword "do", followed by a statement (the action), the keyword "while", and an expression in parentheses (the condition). *IBM.*

**dot.** The file name consisting of a single dot character (.). *X/Open. ISO.1.*

**double-byte character set.** See *DBCS*.

**double-precision.** Pertaining to the use of two computer words to represent a number in accordance with the required precision. *ISO-JTC1. ANSI/ISO.*

**double-quote.** The character ", also known as *quotation mark*. *X/Open.*

This character is named <quotation-mark> in the portable character set.

**doubleword.** A contiguous sequence of bytes or characters that comprises two computer words and is capable of being addressed as a unit. *IBM.*

**dynamic.** Pertaining to an operation that occurs at the time it is needed rather than at a predetermined or fixed time. *IBM.*

**dynamic allocation.** Assignment of system resources to a program when the program is executed rather than when it is loaded into main storage. *IBM.*

**dynamic binding.** The act of resolving references to external variables and functions at run time. In C++, dynamic binding is supported by using virtual functions.

**dynamic link library (DLL).** A file containing executable code and data bound to a program at run time. The code and data in a dynamic link library can be shared by several applications simultaneously. Compiling code with the DLL option does not mean that

the produced executable will be a DLL. To create a DLL, use `#pragma export` or the `EXPORTALL` compiler option.

**DSA (dynamic storage area).** An area of storage obtained during the running of an application that consists of a register save area and an area for automatic data, such as program variables. DSAs are generally allocated within Language Environment-managed stack segments. DSAs are added to the stack when a routine is entered and removed upon exit in a last in, first out (LIFO) manner. In Language Environment, a DSA is known as a stack frame.

**dynamic storage.** Synonym for *automatic storage*.

**dynamic storage area .** See DSA

## E

**EBCDIC.** See *extended binary-coded decimal interchange code*.

**effective group ID.** An attribute of a process that is used in determining various permissions, including file access permissions. This value is subject to change during the process lifetime, as described in the *exec* family of functions and `setgid()`. *X/Open. ISO.1.*

**effective user ID.** (1) The user ID associated with the last authenticated user or the last `setuid()` program. It is equal to either the real or the saved user ID. (2) The current user ID, but not necessarily the user's login ID; for example, a user logged in under a login ID may change to another user's ID. The ID to which the user changes becomes the effective user ID until the user switches back to the original login ID. All discretionary access decisions are based on the effective user ID. *IBM.* (3) An attribute of a process that is used in determining various permissions, including file access permissions. This value is subject to change during the process lifetime, as described in *exec* and `setuid()`. *X/Open. ISO.1.*

**elaborated type specifier.** A specifier typically used in an incomplete class declaration to qualify types that are otherwise hidden.

**element.** The component of an array, subrange, enumeration, or set.

**element equality.** A relation that determines if two elements are equal.

**element occurrence.** A single instance of an element in a collection. In a unique collection, element occurrence is synonymous with element value.

**element value.** All the instances of an element with a particular value in a collection. In a nonunique collection, an element value may have more than one

occurrence. In a unique collection, element value is synonymous with element occurrence.

**else clause.** The part of an if statement that contains the word *else*, followed by a statement. The *else clause* provides an action that is started when the if condition evaluates to a value of zero (*false*). *IBM.*

**empty line.** A line consisting of only a new-line character. *X/Open.*

**empty string.** (1) A string whose first byte is a null byte. Synonymous with *null string*. *X/Open.* (2) A character array whose first element is a null character. *ISO.1.*

**enabled signal.** The occurrence of an enabled signal results in the default system response or the execution of an established signal handler. If disabled, the occurrence of the signal is ignored.

**encapsulation.** Hiding the internal representation of data objects and implementation details of functions from the client program. This enables the end user to focus on the use of data objects and functions without having to know about their representation or implementation.

**enclave.** In z/OS Language Environment, an independent collection of routines, one of which is designated as the main routine. An enclave is roughly analogous to a program or run unit.

**enqueue.** (1) An operation that adds an element as the last element to a queue. (2) Request control of a serially reusable resource.

**entry point.** The address or label of the first instruction that is executed when a routine is entered for execution.

**enumeration constant.** In the C or C++ language, an identifier, with an associated integer value, defined in an enumerator. An enumeration constant may be used anywhere an integer constant is allowed. *IBM.*

**enumeration data type.** (1) In the Fortran, C, and C++ language, a data type that represents a set of values that a user defines. *IBM.* (2) A type that represents integers and a set of enumeration constants. Each enumeration constant has an associated integer value.

**enumeration tag.** In the C and C++ language, the identifier that names an enumeration data type. *IBM.*

**enumeration type.** An enumeration type defines a set of enumeration constants. In the C++ language, an enumeration type is a distinct data type that is not an integral type.

**enumerator.** In the C and C++ language, an enumeration constant and its associated value. *IBM.*

**equivalence class.** (1) A grouping of characters that are considered equal for the purpose of collation; for example, many languages place an uppercase character in the same equivalence class as its lowercase form, but some languages distinguish between accented and unaccented character forms for the purpose of collation. *IBM.* (2) A set of collating elements with the same primary collation weight.

Elements in an equivalence class are typically elements that naturally group together, such as all accented letters based on the same base letter.

The collation order of elements within an equivalence class is determined by the weights assigned on any subsequent levels after the primary weight. *X/Open.*

**escape sequence.** (1) A representation of a character. An escape sequence contains the `\` symbol followed by one of the characters: a, b, f, n, r, t, v, ' , " , x, \ , or followed by one or more octal or hexadecimal digits. (2) A sequence of characters that represent, for example, non-printing characters, or the exact code point value to be used to represent variant and nonvariant characters regardless of code page. (3) In the C and C++ language, an escape character followed by one or more characters. The escape character indicates that a different code, or a different coded character set, is used to interpret the characters that follow. Any member of the character set used at run time can be represented using an escape sequence. (4) A character that is preceded by a backslash character and is interpreted to have a special meaning to the operating system. (5) A sequence sent to a terminal to perform actions such as moving the cursor, changing from normal to reverse video, and clearing the screen. Synonymous with multibyte control. *IBM.*

**exception.** (1) Any user, logic, or system error detected by a function that does not itself deal with the error but passes the error on to a handling routine (also called throwing the exception). (2) In programming languages, an abnormal situation that may arise during execution, that may cause a deviation from the normal execution sequence, and for which facilities exist in a programming language to define, raise, recognize, ignore, and handle it; for example, (ON-) condition in PL/I, exception in ADA. *ISO-JTC1.*

**executable.** A load module or program object which has yet to be loaded into memory for execution.

**executable file.** A regular file acceptable as a new process image file by the equivalent of the *exec* family of functions, and thus usable as one form of a utility. The standard utilities described as compilers can produce executable files, but other unspecified methods of producing executable files may also be provided. The internal format of an executable file is unspecified, but a conforming application cannot assume an executable file is a text file. *X/Open.*

**exception handler.** (1) Exception handlers are catch blocks in C++ applications. Catch blocks catch exceptions when they are thrown from a function enclosed in a try block. Try blocks, catch blocks, and throw expressions are the constructs used to implement formal exception handling in C++ applications. (2) A set of routines used to detect deadlock conditions or to process abnormal condition processing. An exception handler allows the normal running of processes to be interrupted and resumed. *IBM.*

**executable file.** A regular file acceptable as a new process image file by the equivalent of the *exec* family of functions, and thus usable as one form of a utility. The standard utilities described as compilers can produce executable files, but other unspecified methods of producing executable files may also be provided. The internal format of an executable file is unspecified, but a conforming application cannot assume an executable file is a text file. *X/Open.*

**executable program.** A program that has been link-edited and therefore can be run in a processor. *IBM.*

**extended binary-coded data interchange code (EBCDIC).** A coded character set of 256 8-bit characters. *IBM.*

**extended-precision.** Pertaining to the use of more than two computer words to represent a floating point number in accordance with the required precision. In z/OS four computer words are used for an extended-precision number.

**extension.** (1) An element or function not included in the standard language. (2) File name extension.

**external data definition.** A description of a variable appearing outside a function. It causes the system to allocate storage for that variable and makes that variable accessible to all functions that follow the definition and are located in the same file as the definition. *IBM.*

**extern storage class specifier.** A specifier that enables the programmer to declare objects and functions that several source files can use.

## F

**feature test macro (FTM).** A macro (`#define`) used to determine whether a particular set of features will be included from a header. *X/Open. ISO.1.*

**FIFO special file.** A type of file with the property that data written to such a file is read on a first-in-first-out basis. Other characteristics of FIFOs are described in `open()`, `read()`, `write()`, and `lseek()`. *X/Open. ISO.1.*

**file access permissions.** The standard file access control mechanism uses the file permission bits. The



bits are set at the time of file creation by functions such as `open()`, `creat()`, `mkdir()`, and `mkfifo()` and can be changed by `chmod()`. The bits are read by `stat()` or `fstat()`. *X/Open*.

**file descriptor.** (1) A positive integer that the system uses instead of the file name to identify an open file. (2) A per-process unique, non-negative integer used to identify an open file for the purpose of file access. *ISO.1*.

The value of a file descriptor is from zero to `{OPEN_MAX}`—which is defined in `<limits.h>`. A process can have no more than `{OPEN_MAX}` file descriptors open simultaneously. File descriptors may also be used to implement directory streams. *X/Open*.

**file mode.** An object containing the *file mode bits* and file type of a file, as described in `<sys/stat.h>`. *X/Open*.

**file mode bits.** A file's file permission bits, set-user-ID-on-execution bit (`S_ISUID`) and set-group-ID-on-execution bit (`S_ISGID`). *X/Open*.

**file permission bits.** Information about a file that is used, along with other information, to determine if a process has read, write, or execute/search permission to a file. The bits are divided into three parts: owner, group, and other. Each part is used with the corresponding file class of process. These bits are contained in the file mode, as described in `<sys/stat.h>`. The detailed usage of the file permission bits is described in *file access permissions*. *X/Open*. *ISO.1*.

**file scope.** A name declared outside all blocks, classes, and function declarations has file scope and can be used after the point of declaration in a source file.

**filter.** A command whose operation consists of reading data from standard input or a list of input files and writing data to standard output. Typically, its function is to perform some transformation on the data stream. *X/Open*.

**first element.** The element visited first in an iteration over a collection. Each collection has its own definition for first element. For example, the first element of a sorted set is the element with the smallest value.

**flat collection.** A collection that has no hierarchical structure.

**float constant.** (1) A constant representing a nonintegral number. (2) A number containing a decimal point, an exponent, or both a decimal point and an exponent. The exponent contains an `e` or `E`, an optional sign (`+` or `-`), and one or more digits (0 through 9). *IBM*.

**for statement.** A looping statement that contains the word *for* followed by a *for*-initializing-statement, an optional condition, a semicolon, and an optional expression, all enclosed in parentheses.

**foreground process.** (1) A process that must run to completion before another command is issued. The foreground process is in the foreground process group, which is the group that receives the signals generated by a terminal. *IBM*. (2) A process that is a member of a foreground process group. *X/Open*. *ISO.1*.

**foreground process group.** (1) The group that receives the signals generated by a terminal. *IBM*. (2) A process group whose member processes have certain privileges, denied to processes in background process groups, when accessing their controlling terminal. Each session that has established a connection with a controlling terminal has exactly one process group of the session as the foreground process group of that controlling terminal. *X/Open*. *ISO.1*.

**foreground process group ID.** The process group ID of the foreground process group. *X/Open*. *ISO.1*.

**form-feed character.** A character in the output stream that indicates that printing should start on the next page of an output device. The formfeed is the character designated by `'f'` in the C and C++ language. If the formfeed is not the first character of an output line, the result is unspecified. It is unspecified whether this character is the exact sequence transmitted to an output device by the system to accomplish the movement to the next page. *X/Open*.

**forward declaration.** A declaration of a class or function made earlier in a compilation unit, so that the declared class or function can be used before it has been defined.

**freestanding application.** (1) An application that is created to run without the run-time environment or library with which it was developed. (2) An z/OS XL C/C++ application that does not use the services of the dynamic z/OS XL C/C++ run-time library or Language Environment. Under z/OS XL C support, this ability is a feature of the System Programming C support.

**free store.** Dynamically allocated memory. New and delete are used to allocate and deallocate free store.

**friend class.** A class in which all the member functions are granted access to the private and protected members of another class. It is named in the declaration of another class and uses the keyword *friend* as a prefix to the class. For example, the following source code makes all the functions and data in class `you` friends of class `me`:

```
class me {
    friend class you;
    // ...
};
```

**friend function.** A function that is granted access to the private and protected parts of a class. It is named in the declaration of the other class with the prefix *friend*.

**function.** A named group of statements that can be called and evaluated and can return a value to the calling statement. *IBM.*

**function call.** An expression that moves the path of execution from the current function to a specified function and evaluates to the return value provided by the called function. A function call contains the name of the function to which control moves and a parenthesized list of values. *IBM.*

**function declarator.** The part of a function definition that names the function, provides additional information about the return value of the function, and lists the function parameters. *IBM.*

**function definition.** The complete description of a function. A function definition contains a sequence of specifiers (storage class, optional type, inline, virtual, optional friend), a function declarator, optional constructor-initializers, parameter declarations, optional const, and the block statement. Inline, virtual, friend, and const are not available with C.

**function prototype.** A function declaration that provides type information for each parameter. It is the first line of the function (header) followed by a semicolon (;). The declaration is required by the compiler at the time that the function is declared, so that the compiler can check the type.

**function scope.** Labels that are declared in a function have function scope and can be used anywhere in that function after their declaration.

**function template.** Provides a blueprint describing how a set of related individual functions can be constructed.

## G

**Generalization.** Refers to a class, function, or static data member which derives its definition from a template. An instantiation of a template function would be a generalization.

**Generalized Object File Format (GOFF).** An object module format that extends the capabilities of object modules to contain more information than current object modules. It removes the limitations of the previous object module format. It is required for XPLINK.

**generic class.** Synonym for *class templates*.

**global.** Pertaining to information available to more than one program or subroutine. *IBM.*

**global scope.** Synonym for *file scope*.

**global variable.** A symbol defined in one program module that is used in other independently compiled program modules.

**GMT (Greenwich Mean Time).** The solar time at the meridian of Greenwich, formerly used as the prime basis of standard time throughout the world. GMT has been superseded by coordinated universal time (UTC).

**graphic character.** (1) A visual representation of a character, other than a control character, that is normally produced by writing, printing, or displaying. *ISO Draft.* (2) A character that can be displayed or printed. *IBM.*

**Graphical Data Display Manager (GDDM).** Pertaining to an IBM licensed program that provides a group of routines that allows pictures to be defined and displayed procedurally through function routines that correspond to graphic primitives. *IBM.*

**Greenwich Mean Time.** See GMT.

**group ID.** (1) A non-negative integer that is used to identify a group of system users. Each system user is a member of at least one group. When the identity of a group is associated with a process, a group ID value is referred to as a real group ID, an effective group ID, one of the supplementary group IDs or a saved set-group-ID. *X/Open.* (2) A non-negative integer, which can be contained in an object of type *gid\_t*, that is used to identify a group of system users. *ISO.1.*

## H

**halfword.** A contiguous sequence of bytes or characters that constitutes half a computer word and can be addressed as a unit. *IBM.*

**hash function.** A function that determines which category, or bucket, to put an element in. A hash function is needed when implementing a hash table.

**hash table.** (1) A data structure that divides all elements into (preferably) equal-sized categories, or buckets, to allow quick access to the elements. The hash function determines which bucket an element belongs in. (2) A table of information that is accessed by way of a shortened search key (that hash value). Using a hash table minimizes average search time.

**header file.** A text file that contains declarations used by a group of functions, programs, or users.

**heap storage.** An area of storage used for allocation of storage whose lifetime is not related to the execution of the current routine. The heap consists of the initial heap segment and zero or more increments.

**hexadecimal constant.** A constant, usually starting with special characters, that contains only hexadecimal digits. Three examples for the hexadecimal constant with value 0 would be `"x00"`, `'0x0'`, or `'0X00'`.

**High Level Assembler.** An IBM licensed program. Translates symbolic assembler language into binary machine language.

**Hiperspace memory file.** An IBM file used under z/OS to deal with memory files as large as 2 gigabytes. *IBM.*

**hooks.** Instructions inserted into a program by a compiler at compile-time. Using hooks, you can set breakpoints to instruct Debug Tool to gain control of the program at selected points during its execution.

**hybrid code.** Program statements that have not been internationalized with respect to code page, especially where data constants contain variant characters. Such statements can be found in applications written in older implementations of MVS, which required syntax statements to be written using code page IBM-1047 exclusively. Such applications cannot be converted from one code page to another using `iconv()`.

## I

**I18N.** Abbreviation for *internationalization*.

**identifier.** (1) One or more characters used to identify or name a data element and possibly to indicate certain properties of that data element. *ANSI/ISO.* (2) In programming languages, a token that names a data object such as a variable, an array, a record, a subprogram, or a function. *ANSI/ISO.* (3) A sequence of letters, digits, and underscores used to identify a data object or function. *IBM.*

**if statement.** A conditional statement that contains the keyword `if`, followed by an expression in parentheses (the condition), a statement (the action), and an optional `else` clause (the alternative action). *IBM.*

**ILC (interlanguage call).** A function call made by one language to a function coded in another language. Interlanguage calls are used to communicate between programs written in different languages.

**ILC (interlanguage communication).** The ability of routines written in different programming languages to communicate. ILC support enables the application writer to readily build applications from component routines written in a variety of languages.

**implementation-defined behavior.** Application behavior that is not defined by the standards. The implementing compiler and library defines this behavior when a program contains correct program constructs or uses correct data. Programs that rely on implementation-defined behavior may behave differently on different C or C++ implementations. Refer to the z/OS XL C/C++ documents that are listed in “z/OS XL C/C++ and related documents” on page xvii for information about implementation-defined behavior in

the z/OS XL C/C++ environment. Contrast with *unspecified behavior* and *undefined behavior*.

**IMS (Information Management System).** Pertaining to an IBM database/data communication (DB/DC) system that can manage complex databases and networks. *IBM.*

**include directive.** A preprocessor directive that causes the preprocessor to replace the statement with the contents of a specified file.

**include file.** See *header file*.

**incomplete class declaration.** A class declaration that does not define any members of a class. Until a class is fully declared, or defined, you can only use the class name where the size of the class is not required. Typically an incomplete class declaration is used as a forward declaration.

**incomplete type.** A type that has no value or meaning when it is first declared. There are three incomplete types: void, arrays of unknown size and structures and unions of unspecified content. A void type can never be completed. Arrays of unknown size and structures or unions of unspecified content can be completed in further declarations.

**indirection.** (1) A mechanism for connecting objects by storing, in one object, a reference to another object. (2) In the C and C++ languages, the application of the unary operator `*` to a pointer to access the object to which the pointer points.

**indirection class.** Synonym for *reference class*.

**induction variable.** It is a controlling variable of a loop.

**inheritance.** A technique that allows the use of an existing class as the base for creating other classes.

**initial heap.** The z/OS XL C/C++ heap controlled by the HEAP run-time option and designated by a `heap_id` of 0. The initial heap contains dynamically allocated user data.

**initializer.** An expression used to initialize data objects. The C++ language, supports the following types of initializers:

- An expression followed by an assignment operator that is used to initialize fundamental data type objects or class objects that contain copy constructors.
- A parenthesized expression list that is used to initialize base classes and members that use constructors.

Both the C and C++ languages support an expression enclosed in braces ( `{ }` ), that used to initialize aggregates.

**inlined function.** A function whose actual code replaces a function call. A function that is both declared and defined in a class definition is an example of an inline function. Another example is one which you explicitly declared inline by using the keyword `inline`. Both member and non-member functions can be inlined.

**input stream.** A sequence of control statements and data submitted to a system from an input unit. Synonymous with input job stream, job input stream. *IBM.*

**instance.** An object-oriented programming term synonymous with object. An instance is a particular instantiation of a data type. It is simply a region of storage that contains a value or group of values. For example, if a class `box` is previously defined, two instances of a class `box` could be instantiated with the declaration: `box box1, box2;`

**instantiate.** To create or generate a particular instance or object of a data type. For example, an instance `box1` of class `box` could be instantiated with the declaration: `box box1;`

**instruction.** A program statement that specifies an operation to be performed by the computer, along with the values or locations of operands. This statement represents the programmer's request to the processor to perform a specific operation.

**instruction scheduling.** An optimization technique that reorders instructions in code to minimize execution time.

**integer constant.** A decimal, octal, or hexadecimal constant.

**integral object.** A character object, an object having an enumeration type, an object having variations of the type `int`, or an object that is a bit field.

**Interactive System Productivity Facility.** See *ISPF*.

**interlanguage call.** See *ILC (interlanguage call)*.

**interlanguage communication.** See *ILC (interlanguage communication)*.

**internationalization.** The capability of a computer program to adapt to the requirements of different native languages, local customs, and coded character sets. *X/Open.*

Synonymous with *I18N*.

**interoperability.** The capability to communicate, execute programs, or transfer data among various functional units in a way that requires the user to have little or no knowledge of the unique characteristics of those units.

**Interprocedural Analysis.** See *IPA*.

**interprocess communication.** (1) The exchange of information between processes or threads through semaphores, queues, and shared memory. (2) The process by which programs communicate data to each other to synchronize their activities. Semaphores, signals, and internal message queues are common methods of inter-process communication.

**I/O stream library.** A class library that provides the facilities to deal with many varieties of input and output.

**IPA (Interprocedural Analysis).** A process for performing optimizations across compilation units.

**ISPF (Interactive System Productivity Facility).** An IBM licensed program that serves as a full-screen editor and dialogue manager. Used for writing application programs, it provides a means of generating standard screen panels and interactive dialogues between the application programmer and terminal user. (*ISPF*)

**iteration.** The process of repeatedly applying a function to a series of elements in a collection until some condition is satisfied.

## J

**JCL (job control language).** A control language used to identify a job to an operating system and to describe the job's requirement. *IBM.*

## K

**keyword.** (1) A predefined word reserved for the C and C++ languages, that may not be used as an identifier. (2) A symbol that identifies a parameter in JCL.

**kind attribute.** An attribute for a mutex attribute object. This attribute's value determines whether the mutex can be locked once or more than once for a thread and whether state changes to the mutex will be reported to the debug interface.

## L

**label.** An identifier within or attached to a set of data elements. *ISO Draft.*

**Language Environment.** Abbreviated form of z/OS Language Environment. Pertaining to an IBM software product that provides a common run-time environment and run-time services to applications compiled by Language Environment-conforming compilers.

**last element.** The element visited last in an iteration over a collection. Each collection has its own definition for last element. For example, the last element of a sorted set is the element with the largest value.



**late binding.** Allowing the system to determine the specific class of the object and invoke the appropriate function implementations at run time. Late binding or dynamic binding hides the differences between a group of related classes from the application program.

**leaves.** Nodes without children. Synonymous with terminals.

**lexically.** Relating to the left-to-right order of units.

**library.** (1) A collection of functions, calls, subroutines, or other data. *IBM.* (2) A set of object modules that can be specified in a link command.

**linkage editor.** Synonym for linker. The linkage editor has been replaced by the *binder* for the MVS/ESA, OS/390, or z/OS operating systems. See *binder*.

**Linkage.** Refers to the binding between a reference and a definition. A function has internal linkage if the function is defined inline as part of the class, is declared with the inline keyword, or is a non-member function declared with the static keyword. All other functions have external linkage.

**linker.** A computer program for creating load modules from one or more object modules by resolving cross references among the modules and, if necessary, adjusting addresses. *IBM.*

**link pack area (LPA).** In z/OS, an area of storage containing re-enterable routines from system libraries. Their presence in main storage saves loading time.

**literal.** (1) In programming languages, a lexical unit that directly represents a value; for example, 14 represents the integer fourteen, "APRIL" represents the string of characters APRIL, 3.0005E2 represents the number 300.05. *ISO-JTC1.* (2) A symbol or a quantity in a source program that is itself data, rather than a reference to data. *IBM.* (3) A character string whose value is given by the characters themselves; for example, the numeric literal 7 has the value 7, and the character literal CHARACTERS has the value CHARACTERS. *IBM.*

**loader.** A routine, commonly a computer program, that reads data into main storage. *ANSI/ISO.*

**load module.** All or part of a computer program in a form suitable for loading into main storage for execution. A load module is usually the output of a linkage editor. *ISO Draft.*

**local.** (1) In programming languages, pertaining to the relationship between a language object and a block such that the language object has a scope contained in that block. *ISO-JTC1.* (2) Pertaining to that which is defined and used only in one subdivision of a computer program. *ANSI/ISO.*

**local customs.** The conventions of a geographical area or territory for such things as date, time, and currency formats. *X/Open.*

**locale.** The definition of the subset of a user's environment that depends on language and cultural conventions. *X/Open.*

**localization.** The process of establishing information within a computer system specific to the operation of particular native languages, local customs, and coded character sets. *X/Open.*

**local scope.** A name declared in a block has scope within the block, and can therefore only be used in that block.

**Long name.** An external name C++ name in an object module, or and external name in an object module created by the C compiler when the LONGNAME option is used. Long names are up to 1024 characters long and may contain both upper-case and lower-case characters.

**lvalue.** An expression that represents a data object that can be both examined and altered.

## M

**macro.** An identifier followed by arguments (may be a parenthesized list of arguments) that the preprocessor replaces with the replacement code located in a preprocessor #define directive.

**macro call.** Synonym for *macro*.

**macro instruction.** Synonym for *macro*.

**main function.** An external function with the identifier *main* that is the first user function—aside from exit routines and C++ static object constructors—to get control when program execution begins. Each C and C++ program must have exactly one function named *main*.

**makefile.** A text file containing a list of your application's parts. The make utility uses makefiles to maintain application parts and dependencies.

**make utility.** Maintains all of the parts and dependencies for your application. The make utility uses a makefile to keep the parts of your program synchronized. If one part of your application changes, the make utility updates all other files that depend on the changed part. This utility is available under the z/OS shell and by default, uses the c89 utility to recompile and bind your application.

**mangling.** The encoding during compilation of identifiers such as function and variable names to include type and scope information. These mangled names ensure type-safe linkage. See also *demangling*.

**manipulator.** A value that can be inserted into streams or extracted from streams to affect or query the behavior of the stream.

**member.** A data object or function in a structure, union, or class. Members can also be classes, enumerations, bit fields, and type names.

**member function.** (1) An operator or function that is declared as a member of a class. A member function has access to the private and protected data members and member functions of objects of its class. Member functions are also called methods. (2) A function that performs operations on a class.

**method.** In the C++ language, a synonym for *member function*.

**method file.** (1) A file that allows users to indicate to the localedef utility where to look for user-provided methods for processing user-designed codepages. (2) For ASCII locales, a file that defines the method functions to be used by C run-time locale-sensitive interfaces. A method file also identifies where the method functions can be found. IBM supplies several method files used to create its standard set of ASCII locales. Other method files can be created to support customized or user-created codepages. Such customized method files replace IBM-supplied charmap method functions with user-written functions.

**migrate.** To move to a changed operating environment, usually to a new release or version of a system. *IBM*.

**module.** A program unit that usually performs a particular function or related functions, and that is distinct and identifiable with respect to compiling, combining with other units, and loading.

**multibyte character.** A mixture of single-byte characters from a single-byte character set and double-byte characters from a double-byte character set.

**multicharacter collating element.** A sequence of two or more characters that collate as an entity. For example, in some coded character sets, an accented character is represented by a non-spacing accent, followed by the letter. Other examples are the Spanish elements *ch* and *ll*. *X/Open*.

**multiple inheritance.** An object-oriented programming technique implemented in the C++ language through derivation, in which the derived class inherits members from more than one base class.

**multitasking.** A mode of operation that allows concurrent performance, or interleaved execution of two or more tasks. *ISO-JTC1*. *ANSI/ISO*.

**mutex.** A flag used by a semaphore to protect shared resources. The mutex is locked and unlocked by

threads in a program. A mutex can only be locked by one thread at a time and can only be unlocked by the same thread that locked it. The current owner of a mutex is the thread that it is currently locked by. An unlocked mutex has no current owner.

**mutex attribute object.** Allows the user to manage the characteristics of mutexes in their application by defining a set of values to be used for the mutex during its creation. A mutex attribute object allows the user to create many mutexes with the same set of characteristics without redefining the same set of characteristics for each mutex created.

**mutex object.** Used to identify a mutex.

## N

**namespace.** A category used to group similar types of identifiers.

**named pipe.** A FIFO file. Named pipes allow transfer of data between processes in a FIFO manner and synchronization of process execution. Allows processes to communicate even though they do not know what processes are on the other end of the pipe.

**natural reentrancy.** A program that contains no writable static and requires no additional processing to make it reentrant is considered naturally reentrant.

**nested class.** A class defined within the scope of another class.

**nested enclave.** A new enclave created by an existing enclave. The nested enclave that is created must be a new main routine within the process. See also *child enclave* and *parent enclave*.

**newline character.** A character that in the output stream indicates that printing should start at the beginning of the next line. The newline character is designated by '\n' in the C and C++ language. It is unspecified whether this character is the exact sequence transmitted to an output device by the system to accomplish the movement to the next line. *X/Open*.

**nickname.** Synonym for alias.

**non-printing character.** See *control character*.

**null character (NUL).** The ASCII or EBCDIC character '\0' with the hex value 00, all bits turned off. It is used to represent the absence of a printed or displayed character. This character is named <NUL> in the portable character set.

**null pointer.** The value that is obtained by converting the number 0 into a pointer; for example, (void \*) 0. The C and C++ languages guarantee that this value will not match that of any legitimate pointer, so it is used by many functions that return pointers to indicate an error. *X/Open*.

**null statement.** A C or C++ statement that consists solely of a semicolon.

**null string.** (1) A string whose first byte is a null byte. Synonymous with *empty string*. *X/Open*. (2) A character array whose first element is a null character. *ISO.1*.

**null value.** A parameter position for which no value is specified. *IBM*.

**null wide-character code.** A wide-character code with all bits set to zero. *X/Open*.

**number sign.** The character #, also known as *pound sign* and *hash sign*. This character is named <number-sign> in the portable character set.

## O

**object.** (1) A region of storage. An object is created when a variable is defined. An object is destroyed when it goes out of scope. (See also *instance*.) (2) In object-oriented design or programming, an abstraction consisting of data and the operations associated with that data. See also *class*. *IBM*. (3) An instance of a class.

**object code.** Machine-executable instructions, usually generated by a compiler from source code written in a higher level language (such as the C++ language). For programs that must be linked, object code consists of relocatable machine code.

**object module.** (1) All or part of an object program sufficiently complete for linking. Assemblers and compilers usually produce object modules. *ISO Draft*. (2) A set of instructions in machine language produced by a compiler from a source program. *IBM*.

**object-oriented programming.** A programming approach based on the concepts of data abstraction and inheritance. Unlike procedural programming techniques, object-oriented programming concentrates not on how something is accomplished, but on what data objects comprise the problem and how they are manipulated.

**octal constant.** The digit 0 (zero) followed by any digits 0 through 7.

**open file.** A file that is currently associated with a file descriptor. *X/Open*. *ISO.1*.

**operand.** An entity on which an operation is performed. *ISO-JTC1*. *ANSI/ISO*.

**operating system (OS).** Software that controls functions such as resource allocation, scheduling, input/output control, and data management.

**operator function.** An overloaded operator that is either a member of a class or that takes at least one argument that is a class type or a reference to a class type.

**operator precedence.** In programming languages, an order relation defining the sequence of the application of operators within an expression. *ISO-JTC1*.

**orientation of a stream.** After application of an input or output function to a stream, it becomes either byte-oriented or wide-oriented. A byte-oriented stream is a stream that had a byte input or output function applied to it when it had no orientation. A wide-oriented stream is a stream that had a wide character input or output function applied to it when it had no orientation. A stream has no orientation when it has been associated with an external file but has not had any operations performed on it.

**overflow.** (1) A condition that occurs when a portion of the result of an operation exceeds the capacity of the intended unit of storage. (2) That portion of an operation that exceeds the capacity of the intended unit of storage. *IBM*.

**overlay.** The technique of repeatedly using the same areas of internal storage during different stages of a program. *ANSI/ISO*. Unions are used to accomplish this in C and C++.

**overloading.** An object-oriented programming technique that allows you to redefine functions and most standard C++ operators when the functions and operators are used with class types.

## P

**parameter.** (1) In the C and C++ languages, an object declared as part of a function declaration or definition that acquires a value on entry to the function, or an identifier following the macro name in a function-like macro definition. *X/Open*. (2) Data passed between programs or procedures. *IBM*.

**parameter declaration.** A description of a value that a function receives. A parameter declaration determines the storage class and the data type of the value.

**parent enclave.** The enclave that issues a call to system services or language constructs to create a nested or child enclave. See also *child enclave* and *nested enclave*.

**parent process.** (1) The program that originates the creation of other processes by means of *spawn* or *exec* function calls. See also *child process*. (2) A process that creates other processes.

**parent process ID.** (1) An attribute of a new process identifying the parent of the process. The parent process ID of a process is the process ID of its creator,

for the lifetime of the creator. After the creator's lifetime has ended, the parent process ID is the process ID of an implementation-dependent system process. *X/Open*. (2) An attribute of a new process after it is created by a currently active process. *ISO.1*.

**partitioned concatenation.** Specifying multiple PDSs or PDSEs under one ddname. The concatenated data sets act as one big PDS or PDSE and access can be made to any member with a unique name. An attempted access to a member whose name occurs more than once in the concatenated data sets, returns the first member with that name found in the entire concatenation.

**partitioned data set (PDS).** A data set in direct access storage that is divided into partitions, called members, each of which can contain a program, part of a program, or data. *IBM*.

**partitioned data set extended (PDSE).** Similar to *partitioned data set*, but with extended capabilities.

**path name.** (1) A string that is used to identify a file. A path name consists of, at most, {PATH\_MAX} bytes, including the terminating null character. It has an optional beginning slash, followed by zero or more file names separated by slashes. If the path name refers to a directory, it may also have one or more trailing slashes. Multiple successive slashes are treated as one slash. A path name that begins with two successive slashes may be interpreted in an implementation-dependent manner, although more than two leading slashes are treated as a single slash. The interpretation of the path name is described in *path name resolution*. *ISO.1*. (2) A file name specifying all directories leading to the file.

**path name resolution.** Path name resolution is performed for a process to resolve a path name to a particular file in a file hierarchy. There may be multiple path names that resolve to the same file. *X/Open*.

**pattern.** A sequence of characters used either with regular expression notation or for path name expansion, as a means of selecting various characters strings or path names, respectively. The syntaxes of the two patterns are similar, but not identical. *X/Open*.

**period.** The character (.). The term *period* is contrasted against *dot*, which is used to describe a specific directory entry. This character is named <period> in the portable character set.

**permissions.** Codes that determine how a file can be used by any users who work on the system. See also *file access permissions*. *IBM*.

**persistent environment.** A program can explicitly establish a persistent environment, direct functions to it, and explicitly terminate it.

**pointer.** In the C and C++ languages, a variable that holds the address of a data object or a function. *IBM*.

**pointer class.** A class that implements pointers.

**pointer to member.** An operator used to access the address of non-static members of a class.

**polymorphism.** The technique of taking an abstract view of an object or function and using any concrete objects or arguments that are derived from this abstract view.

**portable character set.** The set of characters specified in POSIX 1003.2, section 2.4:

|                     |    |
|---------------------|----|
| <NUL>               |    |
| <alert>             |    |
| <backspace>         |    |
| <tab>               |    |
| <newline>           |    |
| <vertical-tab>      |    |
| <form-feed>         |    |
| <carriage-return>   |    |
| <space>             |    |
| <exclamation-mark>  | !  |
| <quotation-mark>    | "  |
| <number-sign>       | #  |
| <dollar-sign>       | \$ |
| <percent-sign>      | %  |
| <ampersand>         | &  |
| <apostrophe>        | '  |
| <left-parenthesis>  | (  |
| <right-parenthesis> | )  |
| <asterisk>          | *  |
| <plus-sign>         | +  |
| <comma>             | ,  |
| <hyphen>            | -  |
| <hyphen-minus>      | -  |
| <period>            | .  |
| <slash>             | /  |
| <zero>              | 0  |
| <one>               | 1  |
| <two>               | 2  |
| <three>             | 3  |
| <four>              | 4  |
| <five>              | 5  |
| <six>               | 6  |
| <seven>             | 7  |
| <eight>             | 8  |
| <nine>              | 9  |
| <colon>             | :  |
| <semicolon>         | ;  |
| <less-than-sign>    | <  |
| <equals-sign>       | =  |
| <greater-than-sign> | >  |
| <question-mark>     | ?  |
| <commercial-at>     | @  |
| <A>                 | A  |
| <B>                 | B  |
| <C>                 | C  |
| <D>                 | D  |
| <E>                 | E  |
| <F>                 | F  |
| <G>                 | G  |
| <H>                 | H  |
| <I>                 | I  |

|                        |   |
|------------------------|---|
| <J>                    | J |
| <K>                    | K |
| <L>                    | L |
| <M>                    | M |
| <N>                    | N |
| <O>                    | O |
| <P>                    | P |
| <Q>                    | Q |
| <R>                    | R |
| <S>                    | S |
| <T>                    | T |
| <U>                    | U |
| <V>                    | V |
| <W>                    | W |
| <X>                    | X |
| <Y>                    | Y |
| <Z>                    | Z |
| <left-square-bracket>  | [ |
| <backslash>            | \ |
| <reverse-solidus>      | / |
| <right-square-bracket> | ] |
| <circumflex>           | ^ |
| <circumflex-accent>    | ^ |
| <underscore>           | _ |
| <low-line>             | ~ |
| <grave-accent>         | ` |
| <a>                    | a |
| <b>                    | b |
| <c>                    | c |
| <d>                    | d |
| <e>                    | e |
| <f>                    | f |
| <g>                    | g |
| <h>                    | h |
| <i>                    | i |
| <j>                    | j |
| <k>                    | k |
| <l>                    | l |
| <m>                    | m |
| <n>                    | n |
| <o>                    | o |
| <p>                    | p |
| <q>                    | q |
| <r>                    | r |
| <s>                    | s |
| <t>                    | t |
| <u>                    | u |
| <v>                    | v |
| <w>                    | w |
| <x>                    | x |
| <y>                    | y |
| <z>                    | z |
| <left-brace>           | { |
| <left-curly-bracket>   | { |
| <vertical-line>        |   |
| <right-brace>          | } |
| <right-curly-bracket>  | } |
| <tilde>                | ~ |

**portable file name character set.** The set of characters from which portable file names are constructed. For a file name to be portable across implementations conforming to the ISO POSIX-1 standard and to ISO/IEC 9945, it must consist only of the following characters:

```
A B C D E F G H I J K L M N O P Q R S T U V W X
Y Z a b c d e f g h i j k l m n o p q r s t u v
w x y z 0 1 2 3 4 5 6 7 8 9 . _ -
```

The last three characters are the period, underscore, and hyphen characters, respectively. The hyphen must not be used as the first character of a portable file name. Upper- and lower-case letters retain their unique identities between conforming implementations. In the case of a portable path name, the slash character may also be used. *X/Open. ISO.1.*

**portability.** The ability of a programming language to compile successfully on different operating systems without requiring changes to the source code.

**positional parameter.** A parameter that must appear in a specified location relative to other positional parameters. *IBM.*

**precedence.** The priority system for grouping different types of operators with their operands.

**predefined macros.** Frequently used routines provided by an application or language for the programmer.

**preinitialization.** A process by which an environment or library is initialized once and can then be used repeatedly to avoid the inefficiency of initializing the environment or library each time it is needed.

**prelinker.** A utility provided with z/OS Language Environment that you can use to process application programs that require DLL support, or contain either constructed reentrancy or external symbol names that are longer than 8 characters. You require the prelinker, or its equivalent function which is provided by the binder, to process all C++ applications, or C applications that are compiled with the RENT, DLL, LONGNAME or IPA options. As of Version 2 Release 4, the prelinker was superseded by the binder. See also *binder*.

**preprocessor.** A phase of the compiler that examines the source program for preprocessor statements that are then executed, resulting in the alteration of the source program.

**preprocessor statement.** In the C and C++ languages, a statement that begins with the symbol # and is interpreted by the preprocessor during compilation. *IBM.*

**primary expression.** (1) An identifier, parenthesized expression, function call, array element specification, structure member specification, or union member specification. *IBM.* (2) Literals, names, and names qualified by the :: (scope resolution) operator.

**printable character.** One of the characters included in the print character classification of the LC\_CTYPE category in the current locale. *X/Open.*



**private.** Pertaining to a class member that is only accessible to member functions and friends of that class.

**process.** (1) An instance of an executing application and the resources it uses. (2) An address space and single thread of control that executes within that address space, and its required system resources. A process is created by another process issuing the `fork()` function. The process that issues the `fork()` function is known as the parent process, and the new process created by the `fork()` function is known as the child process. *X/Open. ISO.1.*

**process group.** A collection of processes that permits the signaling of related processes. Each process in the system is a member of a process group that is identified by the process group ID. A newly created process joins the process group of its creator. *IBM. X/Open. ISO.1.*

**process group ID.** The unique identifier representing a process group during its lifetime. A process group ID is a positive integer. (Under ISO only, it is a positive integer *that can be contained in a pid\_t*.) A process group ID will not be reused by the system until the process group lifetime ends. *X/Open. ISO.1.*

**process group lifetime.** A period of time that begins when a process group is created and ends when the last remaining process in the group leaves the group, because either it is the end of the last process' lifetime or the last remaining process is calling the `setsid()` or `setpgid()` functions. *X/Open. ISO.1.*

**process ID.** The unique identifier representing a process. A process ID is a positive integer. (Under ISO only, it is a positive integer *that can be contained in a pid\_t*.) A process ID will not be reused by the system until the process lifetime ends. In addition, if there exists a process group whose process group ID is equal to that process ID, the process ID will not be reused by the system until the process group lifetime ends. A process that is not a system process will not have a process ID of 1. *X/Open. ISO.1.*

**process lifetime.** The period of time that begins when a process is created and ends when the process ID is returned to the system. After a process is created with a `fork()` function, it is considered active. Its thread of control and address space exist until it terminates. It then enters an inactive state where certain resources may be returned to the system, although some resources, such as the process ID, are still in use. When another process executes a `wait()` or `waitpid()` function for an inactive process, the remaining resources are returned to the system. The last resource to be returned to the system is the process ID. At this time, the lifetime of the process ends. *X/Open. ISO.1.*

**program object.** All or part of a computer program in a form suitable for loading into main storage for execution. A program object is the output of the `z/OS`

binder and is a newer more flexible format (e.g. longer external names) than a load module.

**protected.** Pertaining to a class member that is only accessible to member functions and friends of that class, or to member functions and friends of classes derived from that class.

**prototype.** A function declaration or definition that includes both the return type of the function and the types of its parameters. See *function prototype*.

**public.** Pertaining to a class member that is accessible to all functions.

**pure virtual function.** A virtual function that has a function definition of `= 0;`. See also *abstract classes*.

## Q

**qualified class name.** Any class name or class name qualified with one or more `::` (scope resolution) operators.

**qualified name.** Used to qualify a non-class type name such as a member by its class name.

**qualified type name.** Used to reduce complex class name syntax by using typedefs to represent qualified class names.

**Query Management Facility (QMF).** Pertaining to an IBM query and report writing facility that enables a variety of tasks such as data entry, query building, administration, and report analysis. *IBM.*

**queue.** A sequence with restricted access in which elements can only be added at the back end (or bottom) and removed from the front end (or top). A queue is characterized by first-in, first-out behavior and chronological order.

**quotation marks.** The characters " and ', also known as *double-quote* and *single-quote* respectively. *X/Open.*

## R

**radix character.** The character that separates the integer part of a number from the fractional part. *X/Open.*

**real group ID.** The attribute of a process that, at the time of process creating, identifies the group of the user who created the process. This value is subject to change during the process lifetime, as describe in `setgid()`. *X/Open. ISO.1.*

**real user ID.** The attribute of a process that, at the time of process creation, identifies the user who created the process. This value is subject to change during the process lifetime, as described in `setuid()`. *X/Open. ISO.1.*

**reason code.** A code that identifies the reason for a detected error. *IBM.*

**reassociation.** An optimization technique that rearranges the sequence of calculations in a subscript expression producing more candidates for common expression elimination.

**redirection.** In the shell, a method of associating files with the input or output of commands. *X/Open.*

**reentrant.** The attribute of a program or routine that allows the same copy of a program or routine to be used concurrently by two or more tasks.

**reference class.** A class that links a concrete class to an abstract class. Reference classes make polymorphism possible with the Collection Classes. Synonymous with *indirection class*.

**refresh.** To ensure that the information on the user's terminal screen is up-to-date. *X/Open.*

**register storage class specifier.** A specifier that indicates to the compiler within a block scope data definition, or a parameter declaration, that the object being described will be heavily used.

**register variable.** A variable defined with the register storage class specifier. Register variables have automatic storage.

**regular expression.** (1) A mechanism to select specific strings from a set of character strings. (2) A set of characters, meta-characters, and operators that define a string or group of strings in a search pattern. (3) A string containing wildcard characters and operations that define a set of one or more possible strings.

**regular file.** A file that is a randomly accessible sequence of bytes, with no further structure imposed by the system. *X/Open. ISO.1.*

**relation.** An unordered flat collection class that uses keys, allows for duplicate elements, and has element equality.

**relative path name.** The name of a directory or file expressed as a sequence of directories followed by a file name, beginning from the current directory. See *path name resolution. IBM.*

**reserved word.** (1) In programming languages, a keyword that may not be used as an identifier. *ISO-JTC1.* (2) A word used in a source program to describe an action to be taken by the program or compiler. It must not appear in the program as a user-defined name or a system name. *IBM.*

**RMODE (residency mode).** In z/OS, a program attribute that refers to where a module is prepared to run. RMODE can be 24 or ANY. ANY refers to the fact

that the module can be loaded either above or below the 16M line. RMODE 24 means the module expects to be loaded below the 16M line.

**RTTI.** Use the RTTI option to generate run-time type identification (RTTI) information for the typeid operator and the dynamic\_cast operator.

**run-time library.** A compiled collection of functions whose members can be referred to by an application program during run-time execution. Typically used to refer to a dynamic library that is provided in object code, such that references to the library are resolved during the linking step. The run-time library itself is not statically bound into the application modules.

## S

**saved set-group-ID.** An attribute of a process that allows some flexibility in the assignment of the effective group ID attribute, as described in the exec() family of functions and setgid(). *X/Open. ISO.1.*

**saved set-user-ID.** An attribute of a process that allows some flexibility in the assignment of the effective user ID attribute, as described in exec() and setuid(). *X/Open. ISO.1.*

**scalar.** An arithmetic object, or a pointer to an object of any type.

**scope.** (1) That part of a source program in which a variable is visible. (2) That part of a source program in which an object is defined and recognized.

**scope operator (::).** An operator that defines the scope for the argument on the right. If the left argument is blank, the scope is global; if the left argument is a class name, the scope is within that class. Synonymous with *scope resolution operator*.

**scope resolution operator (::).** Synonym for *scope operator*.

**semaphore.** An object used by multi-threaded applications for signalling purposes and for controlling access to serially reusable resources. Processes can be locked to a resource with semaphores if the processes follow certain programming conventions.

**sequence.** A sequentially ordered flat collection.

**sequential concatenation.** Multiple sequential data sets or partitioned data-set members are treated as one long sequential data set. In the case of sequential data sets, you can access or update the data sets in order. In the case of partitioned data-set members, you can access or update the members in order. Repositioning is possible if all of the data sets in the concatenation support repositioning.

**sequential data set.** A data set whose records are organized on the basis of their successive physical positions, such as on magnetic tape. *IBM.*

**session.** A collection of process groups established for job control purposes. Each process group is a member of a session. A process is a member of the session of which its process group is a member. A newly created process joins the session of its creator. A process can alter its session membership; see `setsid()`. There can be multiple process groups in the same session. *X/Open. ISO.1.*

**shell.** A program that interprets sequences of text input as commands. It may operate on an input stream or it may interactively prompt and read commands from a terminal. *X/Open.*

This feature is provided as part of the z/OS Shell and Utilities feature licensed program.

**Short name.** An external non-C++ name in an object module produced by compiling with the `NOLONGNAME` option. Such a name is up to 8 characters long and single case.

**signal.** (1) A condition that may or may not be reported during program execution. For example, `SIGFPE` is the signal used to represent erroneous arithmetic operations such as a division by zero. (2) A mechanism by which a process may be notified of, or affected by, an event occurring in the system. Examples of such events include hardware exceptions and specific actions by processes. The term *signal* is also used to refer to the event itself. *X/Open. ISO.1.* (3) A method of interprocess communication that simulates software interrupts. *IBM.*

**signal handler.** A function to be called when the signal is reported.

**single-byte character set (SBCS).** A set of characters in which each character is represented by a one-byte code. *IBM.*

**single-precision.** Pertaining to the use of one computer word to represent a number in accordance with the required precision. *ISO-JTC1. ANSI/ISO.*

**single-quote.** The character `'`, also known as *apostrophe*. This character is named `<quotation-mark>` in the portable character set.

**slash.** The character `/`, also known as *solidus*. This character is named `<slash>` in the portable character set.

**socket.** (1) A unique host identifier created by the concatenation of a port identifier with a transmission control protocol/Internet protocol (TCP/IP) address. (2) A port identifier. (3) A 16-bit port-identifier. (4) A port on a specific host; a communications end point that is

accessible through a protocol family's addressing mechanism. A socket is identified by a socket address. *IBM.*

**sorted map.** A sorted flat collection with key and element equality.

**sorted relation.** A sorted flat collection that uses keys, has element equality, and allows duplicate elements.

**sorted set.** A sorted flat collection with element equality.

**source module.** A file that contains source statements for such items as high-level language programs and data description specifications. *IBM.*

**source program.** A set of instructions written in a programming language that must be translated to machine language before the program can be run. *IBM.*

**space character.** The character defined in the portable character set as `<space>`. The space character is a member of the space character class of the current locale, but represents the single character, and not all of the possible members of the class. *X/Open.*

**spanned record.** A logical record contained in more than one block. *IBM.*

**specialization.** A user-supplied definition which replaces a corresponding template instantiation.

**specifiers.** Used in declarations to indicate storage class, fundamental data type and other properties of the object or function being declared.

**spill area.** A storage area used to save the contents of registers. *IBM.*

**SQL (Structured Query Language).** A language designed to create, access, update and free data tables.

**square brackets.** The characters `[` (left bracket) and `]` (right bracket). Also see *brackets*.

**stack frame.** The physical representation of the activation of a routine. The stack frame is allocated and freed on a LIFO (last in, first out) basis. A stack is a collection of one or more stack segments consisting of an initial stack segment and zero or more increments.

**stack storage.** Synonym for *automatic storage*.

**standard error.** An output stream usually intended to be used for diagnostic messages. *X/Open.*

**standard input.** (1) An input stream usually intended to be used for primary data input. *X/Open.* (2) The primary source of data entered into a command. Standard input comes from the keyboard unless



redirection or piping is used, in which case standard input can be from a file or the output from another command. *IBM*.

**standard output.** (1) An output stream usually intended to be used for primary data output. *X/Open*. (2) The primary destination of data coming from a command. Standard output goes to the display unless redirection or piping is used, in which case standard output can go to a file or to another command. *IBM*.

**statement.** An instruction that ends with the character ; (semicolon) or several instructions that are surrounded by the characters { and }.

**static.** A keyword used for defining the scope and linkage of variables and functions. For internal variables, the variable has block scope and retains its value between function calls. For external values, the variable has file scope and retains its value within the source file. For class variables, the variable is shared by all objects of the class and retains its value within the entire program.

**static binding.** The act of resolving references to external variables and functions before run time.

**storage class specifier.** One of the terms used to specify a storage class, such as auto, register, static, or extern.

**stream.** (1) A continuous stream of data elements being transmitted, or intended for transmission, in character or binary-digit form, using a defined format. (2) A file access object that allows access to an ordered sequence of characters, as described by the ISO C standard. Such objects can be created by the `fdopen()` or `fopen()` functions, and are associated with a file descriptor. A stream provides the additional services of user-selectable buffering and formatted input and output. *X/Open*.

**string.** A contiguous sequence of bytes terminated by and including the first null byte. *X/Open*.

**string constant.** Zero or more characters enclosed in double quotation marks.

**string literal.** Zero or more characters enclosed in double quotation marks.

**striped data set.** A special data set organization that spreads a data set over a specified number of volumes so that I/O parallelism can be exploited. Record  $n$  in a striped data set is found on a volume separate from the volume containing record  $n - p$ , where  $n > p$ .

**struct.** An aggregate of elements having arbitrary types.

**structure.** A construct (a class data type) that contains an ordered group of data objects. Unlike an array, the data objects within a structure can have varied data

types. A structure can be used in all places a class is used. The initial projection is public.

**structure tag.** The identifier that names a structure data type.

**Structured Query Language.** See *SQL*.

**stub routine.** A routine, within a run-time library, that contains the minimum lines of code required to locate a given routine at run time.

**subprogram.** In the IPA Link version of the Inline Report listing section, an equivalent term for 'function'.

**subscript.** One or more expressions, each enclosed in brackets, that follow an array name. A subscript refers to an element in an array.

**subsystem.** A secondary or subordinate system, usually capable of operating independently of or asynchronously with, a controlling system. *ISO Draft*.

**subtree.** A tree structure created by arbitrarily denoting a node to be the root node in a tree. A subtree is always part of a whole tree.

**superset.** Given two sets A and B, A is a superset of B if and only if all elements of B are also elements of A. That is, A is a superset of B if B is a subset of A.

**support.** In system development, to provide the necessary resources for the correct operation of a functional unit. *IBM*.

**switch expression.** The controlling expression of a switch statement.

**switch statement.** A C or C++ language statement that causes control to be transferred to one of several statements depending on the value of an expression.

**system default.** A default value defined in the system profile. *IBM*.

**system process.** (1) An implementation-dependent object, other than a process executing an application, that has a process ID. *X/Open*. (2) An object, other than a process executing an application, that is defined by the system, and has a process ID. *ISO.1*.

## T

**tab character.** A character that in the output stream indicates that printing or displaying should start at the next horizontal tabulation position on the current line. The tab is the character designated by '\t' in the C language. If the current position is at or past the last defined horizontal tabulation position, the behavior is unspecified. It is unspecified whether the character is the exact sequence transmitted to an output device by the system to accomplish the tabulation. *X/Open*.

This character is named <tab> in the portable character set.

**task library.** A class library that provides the facilities to write programs that are made up of tasks.

**template.** A family of classes or functions with variable types.

**template class.** A class instance generated by a class template.

**template function.** A function generated by a function template.

**template instantiation.** The act of creating a new definition of a function, class, or member of a class from a template declaration and one or more template arguments.

**terminals.** Synonym for *leaves*.

**text file.** A file that contains characters organized into one or more lines. The lines must not contain NUL characters and none can exceed {LINE\_MAX}—which is defined in *limits.h*—bytes in length, including the new-line character. The term *text file* does not prevent the inclusion of control or other unprintable characters (other than NUL). *X/Open*.

**thread.** The smallest unit of operation to be performed within a process. *IBM*.

**throw expression.** An argument to the C++ exception being thrown.

**tilde.** The character ~. This character is named <tilde> in the portable character set.

**token.** The smallest independent unit of meaning of a program as defined either by a parser or a lexical analyzer. A token can contain data, a language keyword, an identifier, or other parts of language syntax. *IBM*.

**traceback.** A section of a dump that provides information about the stack frame, the program unit address, the entry point of the routine, the statement number, and the status of the routines on the call-chain at the time the traceback was produced.

**trigraph sequence.** An alternative spelling of some characters to allow the implementation of C in character sets that do not provide a sufficient number of non-alphabetic graphics. *ANSI/ISO*.

Before preprocessing, each trigraph sequence in a string or literal is replaced by the single character that it represents.

**truncate.** To shorten a value to a specified length.

**try block.** A block in which a known C++ exception is passed to a handler.

**type definition.** A definition of a name for a data type. *IBM*.

**type specifier.** Used to indicate the data type of an object or function being declared.

## U

**ultimate consumer.** The target of data in an I/O operation. An ultimate consumer can be a file, a device, or an array of bytes in memory.

**ultimate producer.** The source of data in an I/O operation. An ultimate producer can be a file, a device, or an array of bytes in memory.

**unary expression.** An expression that contains one operand. *IBM*.

**undefined behavior.** Action by the compiler and library when the program uses erroneous constructs or contains erroneous data. Permissible undefined behavior includes ignoring the situation completely with unpredictable results. It also includes behaving in a documented manner that is characteristic of the environment, during translation or program execution, with or without issuing a diagnostic message. It can also include terminating a translation or execution, while issuing a diagnostic message. Contrast with *unspecified behavior* and *implementation-defined behavior*.

**underflow.** (1) A condition that occurs when the result of an operation is less than the smallest possible nonzero number. (2) Synonym for arithmetic underflow, monadic operation. *IBM*.

**union.** (1) In the C or C++ language, a variable that can hold any one of several data types, but only one data type at a time. *IBM*. (2) For bags, there is an additional rule for duplicates: If bag P contains an element *m* times and bag Q contains the same element *n* times, then the union of P and Q contains that element *m+n* times.

**union tag.** The identifier that names a union data type.

**unnamed pipe.** A pipe that is accessible only by the process that created the pipe and its child processes. An unnamed pipe does not have to be opened before it can be used. It is a temporary file that lasts only until the last file descriptor that uses it is closed.

**unique collection.** A collection in which the value of an element only occurs once; that is, there are no duplicate elements.

**unrecoverable error.** An error for which recovery is impossible without use of recovery techniques external to the computer program or run.

**unspecified behavior.** Action by the compiler and library when the program uses correct constructs or data, for which the standards impose no specific

requirements. Such action should not cause compiler or application failure. You should not, however, write any programs to rely on such behavior as they may not be portable to other systems. Contrast with *implementation-defined behavior* and *undefined behavior*.

**user-defined data type.** (1) A mathematical model that includes a structure for storing data and operations that can be performed on that data. Common abstract data types include sets, trees, and heaps. (2) See also *abstract data type*.

**user ID.** A nonnegative integer that is used to identify a system user. (Under ISO only, a nonnegative integer, which can be contained in an object of type *uid\_t*.) When the identity of a user is associated with a process, a user ID value is referred to as a real user ID, an effective user ID, or (under ISO only, and there optionally) a saved set-user ID. *X/Open. ISO.1.*

**user name.** A string that is used to identify a user. *ISO.1.*

**user prefix.** In the z/OS environment, the user prefix is typically the user's logon user identification.

## V

**value numbering.** An optimization technique that involves local constant propagation, local expression elimination, and folding several instructions into a single instruction.

**variable.** In programming languages, a language object that may take different values, one at a time. The values of a variable are usually restricted to a certain data type. *ISO-JTC1.*

**variant character.** A character whose hexadecimal value differs between different character sets. On EBCDIC systems, such as z/OS, these 13 characters are an exception to the portability of the portable character set.

|                        |    |
|------------------------|----|
| <left-square-bracket>  | [  |
| <right-square-bracket> | ]  |
| <left-brace>           | {  |
| <right-brace>          | }  |
| <backslash>            | \  |
| <circumflex>           | ^  |
| <tilde>                | ~  |
| <exclamation-mark>     | !  |
| <number-sign>          | #  |
| <vertical-line>        |    |
| <grave-accent>         | `  |
| <dollar-sign>          | \$ |
| <commercial-at>        | @  |

**vertical-tab character.** A character that in the output stream indicates that printing should start at the next vertical tabulation position. The vertical-tab is the character designated by '\v' in the C or C++ languages. If the current position is at or past the last defined

vertical tabulation position, the behavior is unspecified. It is unspecified whether this character is the exact sequence transmitted to an output device by the system to accomplish the tabulation. *X/Open.* This character is named <vertical-tab> in the portable character set.

**virtual address space.** In virtual storage systems, the virtual storage assigned to a batched or terminal job, a system task, or a task initiated by a command.

**virtual function.** A function of a class that is declared with the keyword *virtual*. The implementation that is executed when you make a call to a virtual function depends on the type of the object for which it is called, which is determined at run time.

**Virtual Storage Access Method (VSAM).** An access method for direct or sequential processing of fixed and variable length records on direct access devices. The records in a VSAM data set or file can be organized in logical sequence by a key field (key sequence), in the physical sequence in which they are written on the data set or file (entry-sequence), or by relative-record number.

**visible.** Visibility of identifiers is based on scoping rules and is independent of *access*.

**volatile attribute.** (1) In the C or C++ language, the keyword *volatile*, used in a definition, declaration, or cast. It causes the compiler to place the value of the data object in storage and to reload this value at each reference to the data object. *IBM.* (2) An attribute of a data object that indicates the object is changeable. Any expression referring to a volatile object is evaluated immediately (for example, assignments).

## W

**while statement.** A looping statement that contains the keyword *while* followed by an expression in parentheses (the condition) and a statement (the action). *IBM.*

**white space.** (1) Space characters, tab characters, form-feed characters, and new-line characters. (2) A sequence of one or more characters that belong to the space character class as defined via the *LC\_CTYPE* category in the current locale. In the POSIX locale, white space consists of one or more blank characters (space and tab characters), new-line characters, carriage-return characters, form-feed characters, and vertical-tab characters. *X/Open.*

**wide-character.** A character whose range of values can represent distinct codes for all members of the largest extended character set specified among the supporting locales.

**wide-character code.** An integral value corresponding to a single graphic symbol or control code. *X/Open.*

**wide-character string.** A contiguous sequence of wide-character codes terminated by and including the first null wide-character code. *X/Open*.

**wide-oriented stream.** See *orientation of a stream*.

**word.** A character string considered as a unit for a given purpose. In z/OS, a word is 32 bits or 4 bytes.

**working directory.** Synonym for *current working directory*.

**writable static area.** See WSA.

**write.** (1) To output characters to a file, such as standard output or standard error. Unless otherwise stated, standard output is the default output destination for all uses of the term *write*. *X/Open*. (2) To make a permanent or transient recording of data in a storage device or on a data medium. *ISO-JTC1. ANSI/ISO*.

**WSA (writable static area).** An area of memory in the program that is modifyable during program execution. Typically, this area contains global variables and function and variable descriptors for DLLs.

## X

**xc.** A utility that uses an external configuration file to control the invocation of the compiler. xc and related commands compile C and C++ source files. They also process assembler source files and object files.

**XPLINK (Extra Performance Linkage).** A new call linkage between functions that has the potential for a significant performance increase when used in an environment of frequent calls between small functions. XPLINK makes subroutine calls more efficient by removing nonessential instructions from the main path. When all functions are compiled with the XPLINK option, pointers can be used without restriction, which makes it easier to port new applications to z/OS.

## Z

**z/OS UNIX System Services.** An element of the z/OS operating system that includes a POSIX system Application Programming Interface for the C language, a shell and utilities component, and a dbx debugger. All the components conform to IEEE POSIX standards (ISO 9945-1: 1990/IEEE POSIX 1003.1-1990, IEEE POSIX 1003.1a, IEEE POSIX 1003.2, and IEEE POSIX 1003.4a).

---

## Bibliography

This bibliography lists the publications for IBM products that are related to z/OS XL C/C++. It includes publications covering the application programming task. The bibliography is not a comprehensive list of the publications for these products, however, it should be adequate for most z/OS XL C/C++ users. Refer to *z/OS Information Roadmap*, SA22-7500, for a complete list of publications belonging to the z/OS product.

Related publications not listed in this section can be found on the *IBM Online Library Omnibus Edition MVS Collection*, SK2T-0710, the *z/OS Collection*, SK3T-4269, or on a tape available with z/OS.

---

### z/OS

- *z/OS Introduction and Release Guide*, GA22-7502
- *z/OS and z/OS.e Planning for Installation*, GA22-7504
- *z/OS Summary of Message and Interface Changes*, SA22-7505
- *z/OS Information Roadmap*, SA22-7500
- *z/OS Licensed Program Specifications*, GA22-7503
- *z/OS Migration*, GA22-7499
- *z/OS Program Directory*, GI10-0670

---

### z/OS XL C/C++

- *z/OS XL C/C++ Programming Guide*, SC09-4765
- *z/OS XL C/C++ User's Guide*, SC09-4767
- *z/OS XL C/C++ Language Reference*, SC09-4815
- *z/OS XL C/C++ Messages*, GC09-4819
- *z/OS XL C/C++ Run-Time Library Reference*, SA22-7821
- *z/OS C Curses*, SA22-7820
- *z/OS XL C/C++ Compiler and Run-Time Migration Guide for the Application Programmer*, GC09-4913
- *IBM Open Class Library Transition Guide*, SC09-4948
- *Standard C++ Library Reference*, SC09-4949

---

### z/OS Run-Time Library Extensions

- *C/C++ Legacy Class Libraries Reference*, SC09-7652
- *z/OS Common Debug Architecture User's Guide*, SC09-7653
- *z/OS Common Debug Architecture Library Reference*, SC09-7654
- *DWARF/ELF Extensions Library Reference*, SC09-7655

---

### Debug Tool

- Debug Tool documentation, which is available at: [www.ibm.com/software/awdtools/debugtool/library/](http://www.ibm.com/software/awdtools/debugtool/library/)

---

## **z/OS Language Environment**

- *z/OS Language Environment Concepts Guide*, SA22-7567
- *z/OS Language Environment Customization*, SA22-7564
- *z/OS Language Environment Debugging Guide*, GA22-7560
- *z/OS Language Environment Programming Guide*, SA22-7561
- *z/OS Language Environment Programming Reference*, SA22-7562
- *z/OS Language Environment Run-Time Application Migration Guide*, GA22-7565
- *z/OS Language Environment Writing Interlanguage Communication Applications*, SA22-7563
- *z/OS Language Environment Run-Time Messages*, SA22-7566

---

## **Assembler**

- *HLASM Language Reference*, SC26-4940
- *HLASM Programmer's Guide*, SC26-4941

---

## **COBOL**

- |
- |
- COBOL documentation, which is available at: <http://www.ibm.com/software/awdtools/cobol/zos/library/>

---

## **PL/I**

- |
- |
- PL/I documentation, which is available at: <http://www.ibm.com/software/awdtools/pli/plizos/library/>

---

## **VS FORTRAN**

- |
- |
- VS FORTRAN documentation, which is available at: <http://www.ibm.com/software/awdtools/fortran/vsfortran/library.html>

---

## **CICS Transaction Server for z/OS**

- |
- |
- CICS documentation, which is available at: <http://www.ibm.com/software/htp/cics/tserver/v31/library/>

---

## **DB2**

- *DB2 Administration Guide*, SC18-7413
- *DB2 Application Programming and SQL Guide*, SC18-7415
- *DB2 ODBC Guide and Reference*, SC18-7423
- *DB2 Command Reference*, SC18-7416
- *DB2 Data Sharing: Planning and Administration*, SC18-7417
- *DB2 Installation Guide*, GC18-7418
- *DB2 Messages and Codes*, GC18-7422
- *DB2 Reference for Remote DRDA Requesters and Servers*, SC18-7424
- *DB2 SQL Reference*, SC18-7426
- *DB2 Utility Guide and Reference*, SC18-7427



---

## IMS/ESA®

- IMS documentation, which is available at: <http://www.ibm.com/software/data/ims/library.html>

---

## MVS

- *z/OS MVS Program Management: User's Guide and Reference*, SA22-7643
- *z/OS MVS Program Management: Advanced Facilities*, SA22-7644

---

## QMF

- QMF documentation, which is available at: <http://www.ibm.com/software/data/qmf/library.html>

---

## DFSMS

- *z/OS DFSMS Introduction*, SC26-7397
- *z/OS DFSMS Managing Catalogs*, SC26-7409
- *z/OS DFSMS Using Data Sets*, SC26-7410
- *z/OS DFSMS Macro Instructions for Data Sets*, SC26-7408
- *z/OS DFSMS Access Method Services for Catalogs*, SC26-7394





# INDEX

## Special characters

-q options syntax 538  
#pragma  
    See runtime options

## A

abbreviated compiler options 53, 56  
Abstract Code Unit (ACU) 121  
accessibility 623  
ACU (Abstract Code Unit) 121  
AGGRCOPY compiler option 67  
AGGREGATE compiler option 68, 601  
aggregate layout 601  
ALIAS compiler option 68  
allocation, standard files with BPXBATCH 481  
AMODE restriction 415  
ANSIALIAS compiler option 69  
ar utility  
    creating archive libraries 479  
    maintaining program objects 479  
ARCHITECTURE compiler option 72  
archive libraries  
    ar utility 479  
    creating 479  
    displaying the object files in 479  
    file naming convention for c89 use 479  
ARGPARSE compiler option 74  
argv, under TSO 413  
as shell command  
    options 485  
ASCII compiler option 75  
assemble  
    z/OS C and z/OS C++ source files 490  
assembler  
    generation of C structures 464  
    macros 605  
ATTACH assembler macro 605  
ATTRIBUTE compiler option 76, 601  
attributes, for DD statements 425  
AUTO prelinker option 591  
automatic library call  
    input to linkage editor 556  
    library search processing 386  
    prelinking and 569  
    processing 384  
    SYSLIB data set 555

## B

binding 11  
BITF0XL DSECT utility option 456  
BITFIELD compiler option 77  
BLKSIZE DSECT utility option 464  
BookManager documents xxii  
BPARAM JCL parameter 423

BPXBATCH program  
    invoking from TSO/E 416  
    invoking from z/OS batch 416  
    running an executable z/OS UNIX System Services  
        file 416  
    syntax 481

## C

C language 6  
c++ 489  
C++ language 6  
c++\_64 528  
c++\_x 528  
C370LIB  
    EXEC 438  
c89 489  
c89 utility  
    compiling and binding application programs 309  
    compiling source and object files 306  
    invoked through the make utility 311  
    linkage editor options 580  
    run by the make utility 306  
c89\_64 528  
c89\_x 528  
c89/cc/c++ environment variable  
    \_ACCEPTABLE\_RC 505  
    \_ASUFFIX 505  
    \_ASUFFIX\_HOST 505  
    \_CCMODE 505  
    \_CLASSLIB\_PREFIX 505  
    \_CLASSVERSION 506  
    \_CLIB\_PREFIX 506  
    \_CMEMORY 506  
    \_CMSGGS 507  
    \_CNAME 507  
    \_CSUFFIX 507  
    \_CSUFFIX\_HOST 507  
    \_CSYSLIB 507  
    \_CVERSION 507  
    \_CXXSUFFIX 508  
    \_CXXSUFFIX\_HOST 508  
    \_DAMPLEVEL 508  
    \_DAMPNAME 508  
    \_DCB121M 508  
    \_DCB133M 508  
    \_DCB137 509  
    \_DCB137A 509  
    \_DCB3200 509  
    \_DCB80 509  
    \_DCBF2008 508  
    \_DCBU 508  
    \_DEBUG\_FORMAT 509  
    \_ELINES 509  
    \_EXTRA\_ARGS 509  
    \_IL6SYSIX 509  
    \_ILCTL 510  
    \_ILMSGGS 510

c89/cc/c++ environment variable (continued)

\_ILNAME 510  
 \_ILSUFFIX 510  
 \_ILSUFFIX\_HOST 510  
 \_ILSYSIX 510  
 \_ILSYSLIB 510  
 \_ILXSYSIX 510  
 \_ILXSYSLIB 510  
 \_INCDIRS 511  
 \_INCLIBS 511  
 \_ISUFFIX 511  
 \_ISUFFIX\_HOST 511  
 \_IXXSUFFIX 511  
 \_IXXSUFFIX\_HOST 511  
 \_L6SYSIX 511  
 \_L6SYSLIB 511  
 \_LIBDIRS 511  
 \_LSYSLIB 511  
 \_LXSYSIX 512  
 \_LXSYSLIB 512  
 \_MEMORY 512  
 \_NEW\_DATACLAS 512  
 \_NEW\_DSNTYPE 512  
 \_NEW\_MGMTCLAS 512  
 \_NEW\_SPACE 512  
 \_NEW\_STORCLAS 513  
 \_NEW\_UNIT 513  
 \_NOCMDOPTS 513  
 \_OPERANDS 513  
 \_OPTIONS 513  
 \_OSUFFIX 513  
 \_OSUFFIX\_HOST 513  
 \_OSUFFIX\_HOSTQUAL 513  
 \_OSUFFIX\_HOSTRULE 513  
 \_PMEMORY 514  
 \_PMSGs 515  
 \_PNAME 515  
 \_PSUFFIX 515  
 \_PSUFFIX\_HOST 515  
 \_PSYSIX 515  
 \_PSYSLIB 515  
 \_PVERSION 515  
 \_SLIB\_PREFIX 516  
 \_SNAME 516  
 \_SSUFFIX 516  
 \_SSUFFIX\_HOST 516  
 \_SSYSLIB 516  
 \_STEPS 516  
 \_SUSRLIB 517  
 \_TMPS 517  
 \_WORK\_DATACLAS 517  
 \_WORK\_DSNTYPE 517  
 \_WORK\_MGMTCLAS 517  
 \_WORK\_SPACE 517  
 \_WORK\_STORCLAS 517  
 \_WORK\_UNIT 518  
 \_XSUFFIX 518  
 \_XSUFFIX\_HOST 518  
 IL6SYSLIB 510

c89/cc/c++ shell command

-W option  
     compiler, prelinker, IPA linker and link editor  
     options 497  
     DLL and IPA extensions 497  
 environment variables 504  
 options 491  
 specifying  
     system and operational information to  
         c89/cc/c++/cxx 504  
 c99 528  
 c99\_64 528  
 c99\_x 528  
 CALL  
     assembler macro 605  
     command 413  
     command, under TSO 413  
 CALLBACKANY 97  
 cataloged procedures  
     descriptions  
         CBCB 366  
         CBCCB 366  
         CBCCBG 366  
         CBCCL 570  
         CBCCLG 570  
         CBCI 419  
         CBCL 570  
         CBCLG 570  
         CBCQB 366, 419  
         CBCQBG 366, 419  
         CBCQCB 366, 419  
         CBCQCBG 366, 419  
         CBCXB 366  
         CBCXBG 366  
         CBCXCB 366  
         CBCXCBG 366  
         CBCXG 366  
         CBCXI 419  
         CCNPD1B 366, 419  
         CCNQPD1B 366  
         CCNXP1B 366, 419  
     data sets used by 425  
     EDCB 366  
     EDCC 419  
     EDCCB 366, 419  
     EDCCBG 366, 419  
     EDCCL 419  
     EDCCLGB 419  
     EDCCLIB 419, 437  
     EDCCPLG 419  
     EDCCSECT 419  
     EDCGNXL 472  
     EDCI 419  
     EDCICONV 469  
     EDCLDEF 474  
     EDCLIB 419, 437  
     EDCPL 419  
     EDCQB 366, 419  
     EDCQBG 366, 419  
     EDCQCB 366, 419  
     EDCQCBG 366, 419

- cataloged procedures (*continued*)
  - descriptions (*continued*)
    - EDCXB 419
    - EDXCXB 366
    - EDXCXBG 366
    - EDCXI 419
    - EDCXLDEF 366
  - for binding 366
  - for compiling, prelinking and linking 569
  - for compiling, prelinking, linking and running 569
  - for prelinking and linking 569
  - for prelinking, linking and running 569
  - for specifying prelinker and linkage editor options 570
  - specifying run-time options 412
- CBCB cataloged procedure 366
- CBCCB cataloged procedure 366
- CBCCBG cataloged procedure 366
- CBCCL cataloged procedure 570
- CBCCLG cataloged procedure 570
- CBCL cataloged procedure 570
- CBCLG cataloged procedure 570
- CBCXB cataloged procedure 366
- CBCXBG cataloged procedure 366
- CBCXCB cataloged procedure 366
- CBCXCBG cataloged procedure 366
- cc 489
- CC REXX EXEC
  - C370LIB parameter 439
  - new syntax 302
  - old syntax 431
  - using under TSO 305
  - using with z/OS UNIX System Services 304
- cc\_64 528
- cc\_x 528
- CCN message prefix 595
- CCNPD1B cataloged procedure 366
- CCNQPD1B cataloged procedure 366
- CCNXP1B cataloged procedure 366
- CDSECT EXEC 468
- CEE message prefix 595
- CEESTART
  - CSECT 557
  - START compiler option 195
  - STATICINLINE compiler option 195
- character
  - trigraph representation 598
  - unprintable 598
- characters
  - converting from one code set to another 471
- CHARS compiler option 77
- CHECKOUT compiler option 78, 598, 601
- CICS compiler option 80
- class libraries 8
  - compiling with 328
  - input to the prelinker 569
- class names used with CXXFILT 449
- CLASSNAME option of CXXFILT utility 451
- CMOD REXX EXEC, syntax 432
- code set conversion utilities
  - genxlt
    - TSO 472
    - usage 469
    - z/OS Batch 472
  - iconv
    - TSO 470
    - usage 469
    - z/OS Batch 469
- command
  - syntax diagrams xvi
- COMMENT DSECT utility option 457
- common features of z/OS XL C and XL C++ compilers 6
- COMPACT compiler option 82
- compile
  - link-edit object file 490
  - z/OS C and z/OS C++ source file 490
- compile-time error 598
- compiler
  - See also* compiler options
  - See also* compiling
  - c89 utility interface to 307
  - error messages 105
  - input 291, 300
    - valid input/output file types 295
  - listing
    - include file option (SHOWINC) 187
    - list inlined subprograms (INLRPT) 123
    - object module option (LIST) 146
    - source program option (SOURCE) 187
    - z/OS XL C cross reference listing 255
    - z/OS XL C error messages 255
    - z/OS XL C external symbol cross reference 257
    - z/OS XL C external symbol dictionary 257
    - z/OS XL C heading information 254
    - z/OS XL C includes section 255
    - z/OS XL C inline report 256
    - z/OS XL C object code 257
    - z/OS XL C prolog 255
    - z/OS XL C pseudo assembly listing 257
    - z/OS XL C source program 255
    - z/OS XL C static map 257
    - z/OS XL C storage offset listing 257, 271
    - z/OS XL C structure and union maps 255
    - z/OS XL C++ cross reference listing 269
    - z/OS XL C++ error messages 269
    - z/OS XL C++ external symbol cross reference 271
    - z/OS XL C++ external symbol dictionary 271
    - z/OS XL C++ heading information 268
    - z/OS XL C++ includes section 269
    - z/OS XL C++ inline report 270
    - z/OS XL C++ object code 271
    - z/OS XL C++ prolog 268
    - z/OS XL C++ pseudo assembly listing 271
    - z/OS XL C++ source program 269
    - z/OS XL C++ static map 271, 282
- object module optimization 169
- options to produce debug information
  - AGGREGATE 601

- compiler (*continued*)
  - options to produce debug information (*continued*)
    - ATTRIBUTE 601
    - CHECKOUT 598, 601
    - DEBUG 601
    - EXPMAC 601
    - FLAG 601
    - GONUMBER 602
    - INFO 602
    - INLINE 602
    - INLRPT 602
    - LIST 602
    - MARGINS 598
    - NOMARGINS 598
    - NOOPTIMIZE 598
    - NOSEQUENCE 598
    - OFFSET 602
    - OPTIMIZE 598
    - PPONLY 598, 602
    - SEQUENCE 598
    - SHOWINC 602
    - SOURCE 602
    - TEST 602
    - XREF 602
  - output
    - create listing file 294
    - create object module 294
    - create preprocessor output 294
    - create template instantiation output 294
    - using compiler options to specify 292
    - using DD statements to specify 302
    - valid input/output file types 295
- compiler options
  - #pragma options 49
  - abbreviations 53, 56
  - defaults 53, 56
  - IPA considerations 46
  - overriding defaults 45
  - pragma options 49
  - specifying under TSO 305
- compiling
  - See also* compiler
  - See also* compiler options
  - dynamically with z/OS macro instructions 605
  - TSO, under 302
  - using cataloged procedures supplied by IBM 296, 331
  - using compiler invocation command names
    - supported by c89 and xlc to compile and bind 309
  - using make to compile and bind 311
- compiling and binding in one step using compiler
  - invocation command names supported by c89 and xlc 309
- COMPRESS compiler option 83
- concatenation
  - multiple libraries 301
- concatenation, multiple libraries 301
- configuration file for xlc 531
  - default name 535
- continuation character
  - prelinker control statements 582
- control section (CSECT)
  - See* CSECT (control section)
- control statements
  - IMPORT, prelinker 583
  - INCLUDE 573
  - INCLUDE, prelinker 583
  - LIBRARY 573
  - LIBRARY, prelinker 584
  - linkage editor 572
  - processing 582
  - RENAME, prelinker 585
- convert
  - characters from one code set to another 471
  - source definitions for locale categories 475
- Convlit 80, 82, 83, 84
- CONVLIT compiler option 84
- CPARM JCL parameter 423
- CPLINK REXX EXEC
  - example 578
  - syntax 576
- create executable files 490
- cross reference listing 602
- cross reference table
  - creating with XPLINK compiler option 216
  - creating with XREF compiler option 220
  - z/OS XL C listing 255
  - z/OS XL C++ listing 269
- CSECT (control section)
  - CEESTART 557
  - compiler option 86
  - pragma 553
  - CSECT compiler option 86
  - customizing locales 473
  - CVFT compiler option 89
- cxx 489
- CXX REXX EXEC
  - syntax 302
  - using under TSO 305
  - using with z/OS UNIX System Services 304
- cxx\_64 528
- cxx\_x 528
- CXXBIND REXX EXEC 378
- CXXFILT utility
  - class names 449
  - input under TSO 452
  - input under z/OS batch 451
  - options 450
  - overview 449
  - PROC for z/OS 451
  - regular names 449
  - special names 449
  - termination 453
  - termination under z/OS batch 452
  - TSO 452
  - unknown names 451
  - z/OS batch 451
- CXXMOD REXX EXEC
  - keyword parameters
    - LIB 575
    - LIST 576
    - LOAD 576

CXXMOD REXX EXEC *(continued)*  
 keyword parameters *(continued)*  
 LOPT 575  
 OBJ 575  
 PLIB 575  
 PMAP 576  
 PMOD 575  
 POPT 575  
 syntax 574

## D

data sets  
 concatenating 301  
 for linking 554  
 for prelinking 550  
 supported attributes 425  
 usage 424  
 user prefixes 27, 36  
 data types, preserving unsignedness 214  
 DBRMLIB compiler option 90  
 dbx 9  
 DD statement  
 for linkage editor data sets 554  
 for prelinker data sets 550  
 ddname  
 alternative 605  
 defaults 424  
 DEBUG compiler option 91, 601  
 Debug Tool 18  
 debugging  
 Debug Tool 18  
 error traceback (GONUMBER compiler option) 111  
 errors 78, 101  
 SERVICE compiler option 186  
 TEST compiler option 206  
 DECIMAL DSECT utility option 457  
 default  
 compiler options 53, 56  
 output file names 146  
 overriding compiler option 45  
 DEFINE compiler option 94  
 define local environments 475  
 definition side-deck 558  
 DEFSUB DSECT utility option 458  
 digraphs, DIGRAPH compiler option 95  
 disability 623  
 disk search sequence  
 LSEARCH compiler option 153  
 SEARCH compiler option 183  
 DLL (dynamic link library)  
 building 559  
 definition side-deck 563  
 description of 498  
 DLL compiler option 97  
 DLLNAME() prelinker option 559  
 EXPORTALL compiler option 104  
 IMPORT control statement 559  
 link-editing 498  
 NAME control statement 559  
 prelinking 550

DLL (dynamic link library) *(continued)*  
 prelinking a DLL 558  
 prelinking a DLL application 558  
 doublebyte characters, converting 471  
 downward compatibility 10  
 DSECT utility  
 BITF0XL option 456  
 BLKSIZE option 464  
 COMMENT option 457  
 DECIMAL option 457  
 DEFSUB option 458  
 EQUATE option 459  
 HDRSKIP option 461  
 INDENT option 461  
 LOCALE option 461  
 LOWERCASE option 462  
 LP64 option 462  
 LRECL option 464  
 OUTPUT option 464  
 PPCOND option 462  
 RECFM option 464  
 SECT option 455  
 SEQUENCE option 463  
 structure produced 464  
 TSO 468  
 UNIQUE option 463  
 UNNAMED option 464  
 z/OS batch 467  
 DUP prelinker option 591  
 Dynamic Link Libraries (DLLs)  
 See DLLs  
 dynamic link library (DLL)  
 description of 498  
 link-editing 498

## E

EDC message prefix 595  
 EDCB cataloged procedure 366  
 EDCCB 368  
 EDCCB cataloged procedure 366  
 EDCCBG cataloged procedure 366  
 EDCCLIB cataloged procedure 437  
 EDCDSECT cataloged procedure 467  
 EDCGNXLT cataloged procedure 472  
 EDCICONV cataloged procedure 469  
 EDCLDEF cataloged procedure 474  
 EDCLDEF CLIST 474  
 EDCLIB cataloged procedure 437  
 EDCXCB cataloged procedure 366  
 EDCXCBG cataloged procedure 366  
 efficiency, object module optimization 169  
 ENTRY linkage editor control statement 558  
 ENUMSIZE compiler option 99  
 environment variable  
 \_ACCEPTABLE\_RC  
 used by c89/cc/c++ 505  
 \_ASUFFIX  
 used by c89/cc/c++ 505  
 \_ASUFFIX\_HOST  
 used by c89/cc/c++ 505

## environment variable (continued)

|                  |                    |     |
|------------------|--------------------|-----|
| _CCMODE          | used by c89/cc/c++ | 505 |
| _CLASSLIB_PREFIX | used by c89/cc/c++ | 505 |
| _CLASSVERSION    | used by c89/cc/c++ | 506 |
| _CLIB_PREFIX     | used by c89/cc/c++ | 506 |
| _CMEMORY         | used by c89/cc/c++ | 506 |
| _CMSGS           | used by c89/cc/c++ | 507 |
| _CNAME           | used by c89/cc/c++ | 507 |
| _CSUFFIX         | used by c89/cc/c++ | 507 |
| _CSYSLIB         | used by c89/cc/c++ | 507 |
| _CVERSION        | used by c89/cc/c++ | 507 |
| _CXXSUFFIX       | used by c89/cc/c++ | 508 |
| _CXXSUFFIX_HOST  | used by c89/cc/c++ | 508 |
| _DAMPLEVEL       | used by c89/cc/c++ | 508 |
| _DAMPNAME        | used by c89/cc/c++ | 508 |
| _DCB121M         | used by c89/cc/c++ | 508 |
| _DCB133M         | used by c89/cc/c++ | 508 |
| _DCB137          | used by c89/cc/c++ | 509 |
| _DCB137A         | used by c89/cc/c++ | 509 |
| _DCB3200         | used by c89/cc/c++ | 509 |
| _DCB80           | used by c89/cc/c++ | 509 |
| _DCBF2008        | used by c89/cc/c++ | 508 |
| _DCBU            | used by c89/cc/c++ | 508 |
| _DEBUG_FORMAT    | used by c89/cc/c++ | 509 |
| _ELINES          | used by c89/cc/c++ | 509 |
| _EXTRA_ARGS      | used by c89/cc/c++ | 509 |
| _IL6SYSIX        | used by c89/cc     | 509 |
| _IL6SYSLIB       | used by c89/cc     | 510 |
| _ILCTL           | used by c89/cc     | 510 |
| _ILMSGS          | used by c89/cc     | 510 |
| _ILNAME          | used by c89/cc/c++ | 510 |

## environment variable (continued)

|                   |                    |     |
|-------------------|--------------------|-----|
| _ILSUFFIX         | used by c89/cc     | 510 |
| _ILSUFFIX_HOST    | used by c89/cc     | 510 |
| _ILSYSIX          | used by c89/cc/c++ | 510 |
| _ILSYSLIB         | used by c89/cc/c++ | 510 |
| _ILXSYSIX         | used by c89/cc/c++ | 510 |
| _ILXSYSLIB        | used by c89/cc/c++ | 510 |
| _INCDIRS          | used by c89/cc/c++ | 511 |
| _INCLIBS          | used by c89/cc/c++ | 511 |
| _ISUFFIX          | used by c89/cc/c++ | 511 |
| _ISUFFIX_HOST     | used by c89/cc/c++ | 511 |
| _IXXSUFFIX        | used by c89/cc/c++ | 511 |
| _L6SYSIX          | used by c89/cc/c++ | 511 |
| _L6SYSLIB         | used by c89/cc/c++ | 511 |
| _LIBDIRS          | used by c89/cc/c++ | 511 |
| _LSYSLIB          | used by c89/cc/c++ | 511 |
| _LXSYSIX          | used by c89/cc/c++ | 512 |
| _LXSYSLIB         | used by c89/cc/c++ | 512 |
| _MEMORY           | used by c89/cc/c++ | 512 |
| _NEW_DATACLAS     | used by c89/cc/c++ | 512 |
| _NEW_DSNTYPE      | used by c89/cc/c++ | 512 |
| _NEW_MGMTCLAS     | used by c89/cc/c++ | 512 |
| _NEW_SPACE        | used by c89/cc/c++ | 512 |
| _NEW_STORCLAS     | used by c89/cc/c++ | 513 |
| _NEW_UNIT         | used by c89/cc/c++ | 513 |
| _NOCMDOPTS        | used by c89/cc/c++ | 513 |
| _OPERANDS         | used by c89/cc/c++ | 513 |
| _OPTIONS          | used by c89/cc/c++ | 513 |
| _OSUFFIX          | used by c89/cc/c++ | 513 |
| _OSUFFIX_HOST     | used by c89/cc/c++ | 513 |
| _OSUFFIX_HOSTQUAL | used by c89/cc/c++ | 513 |



environment variable *(continued)*

- \_OSUFFIX\_HOSTRULE
  - used by c89/cc/c++ 513
- \_PLIB\_PREFIX
  - used by c89/cc/c++ 514
- \_PMEMORY
  - used by c89/cc/c++ 514
- \_PMSGs
  - used by c89/cc/c++ 515
- \_PNAME
  - used by c89/cc/c++ 515
- \_PSUFFIX
  - used by c89/cc/c++ 515
- \_PSUFFIX\_HOST
  - used by c89/cc/c++ 515
- \_PSYSIX
  - used by c89/cc/c++ 515
- \_PSYSLIB
  - used by c89/cc/c++ 515
- \_PVERSION
  - used by c89/cc/c++ 515
- \_SLIB\_PREFIX
  - used by c89/cc/c++ 516
- \_SNAME
  - used by c89/cc/c++ 516
- \_SSUFFIX
  - used by c89/cc/c++ 516
- \_SSUFFIX\_HOST
  - used by c89/cc/c++ 516
- \_SSYSLIB
  - used by c89/cc/c++ 516
- \_STEPS
  - used by c89/cc/c++ 516
- \_SUSRLIB
  - used by c89/cc/c++ 517
- \_TMPS
  - used by c89/cc/c++ 517
- \_WORK\_DATACLAS
  - used by c89/cc/c++ 517
- \_WORK\_DSNTYPE
  - used by c89/cc/c++ 517
- \_WORK\_MGMTCLAS
  - used by c89/cc/c++ 517
- \_WORK\_SPACE
  - used by c89/cc/c++ 517
- \_WORK\_STORCLAS
  - used by c89/cc/c++ 517
- \_WORK\_UNIT
  - used by c89/cc/c++ 518
- \_XSUFFIX
  - used by c89/cc/c++ 518
- \_XSUFFIX\_HOST
  - used by c89/cc/c++ 518
- LIBPATH
  - used by c89/cc/c++ 499
  - used to specify system and operational information to c89/cc/c++/cxx 504
  - used to specify system and operational information to xlc/xlC 530
- environment, defining local 475
- EQA message prefix 595
- EQUATE DSECT utility option
  - BIT suboption 459
  - BITL suboption 460
  - DEF suboption 460
- ER prelinker option 591
- error
  - compile-time 598
  - determining source of 595
  - link time 601
  - messages
    - directing to your terminal 206
    - re-creating 597, 598
    - run-time 601
- escape sequence 598
- escaping special characters 48, 298, 304
- EVENTS compiler option 101
- example
  - ccnghi1.c 332
  - ccnghi2.c 332
  - ccnghi3.c 333
  - ccnuaam 25
  - ccnuaan 26
  - ccnuaap 607
  - ccnuaaq 609
  - ccnuaar 610
  - ccnuaas 612
  - ccnuaat 613
  - ccnuaau 615
  - ccnubrc 34
  - ccnubr.h 32
  - ccnuncl 42
  - clb3atmp.cxx 40
- examples
  - assembler macro 607
  - compile, link and run 36, 41
  - machine-readable xxii
  - naming of xxii
  - sample program 31
  - sample template program 39
  - softcopy xxii
  - z/OS XL C source 25
  - z/OS XL C++ source 31
- exception handling
  - compiler error message severity levels 105
  - linkage editor 557
- EXEC
  - JCL statement
    - GPARM parameter 412
    - specifying run-time options 411
  - statement
    - invoking linkage editor 571
    - invoking prelinker 571
  - supplied by IBM
    - CDSECT 468
    - DLLRNAME 419
    - GENXLT 472
    - ICONV 469
- EXECOPS compiler option 102
- executable
  - files
    - invoking z/OS load modules from the shell 415

executable (*continued*)  
 files (*continued*)  
   placing z/OS load modules in z/OS UNIX System Services 415  
   running 416  
   running, under z/OS batch 410  
   reentrant 524  
 executable file  
   creating 490  
 EXH compiler option 103  
 EXPMAC compiler option 103, 601  
 EXPORTALL compiler option 104  
 external  
   entry points 68  
   names  
     long name support 150  
     prelinker 550  
   references  
     resolving 579  
     unresolved 591  
   variables  
     exporting 104  
     importing 104

## F

FASTTEMPINC compiler option 104  
 feature test macro 316  
 files  
   names  
     generated default 146  
     include files 317  
     user prefixes 27, 36  
     searching paths 153, 183  
 FLAG compiler option 105, 601  
 flag options syntax 540  
 FLOAT  
   C/C++ programs 492  
   floating-point numbers 492  
   select format of floating-point numbers 492  
 FLOAT compiler option 106  
 functions  
   exporting 104  
   importing 104  
   linking 557

## G

genxlt utility  
   CLIST 472  
   TSO 472  
   usage 469  
   z/OS Batch 472  
 GOFF compiler option 111  
 GONUMBER  
   C/C++ programs 494  
   debugging 494  
   improved performance 494  
 GONUMBER compiler option 111, 602  
 GPARM  
   JCL parameter 424

GPARM (*continued*)  
   parameter of EXEC statement 412

## H

HALT compiler option 113  
 HALTONMSG compiler option 113  
 HDRSKIP DSECT utility option 461  
 header files  
   *See also* include files  
   system 301  
 heading information  
   for IPA Link listings 278  
   for z/OS XL C listings 254  
   for z/OS XL C++ listings 268  
 HFS (Hierarchical File System)  
   placing z/OS load modules 415  
 HGPR compiler option 114  
 HOT compiler option 114

## I

I/O interfaces 15  
 IBM message prefix 595  
 iconv shell command 471  
 iconv utility  
   CLIST 470  
   TSO 470  
   usage 469  
   z/OS Batch 469  
 IGNERRNO compiler option 115  
 IGZ message prefix 595  
 ILP32 compiler option 150  
 IMPORT statement  
   syntax description 583  
 improved debugging  
   GONUMBER 494  
 improved performance  
   XPLINK 500  
 IMS  
   PLIST compiler option 173  
 INCLUDE control statement  
   for prelinking and linking 573  
   linkage editor and 556  
   syntax description 583  
   z/OS XL C/C++ prelinker and 583  
 include files  
   naming 317  
   nested 163  
   preprocessor directive  
     syntax 316  
   record format 316  
   SHOWINC compiler option 187  
   system files and libraries  
     OPTFILE compiler option 167  
     SEARCH compiler option 183  
     using 316  
   user files and libraries  
     using 316  
 INDENT DSECT utility option 461  
 INFILE parameter 423



- INFO compiler option 116, 602
- INITAUTO compiler option 118
- inline
  - report for IPA inliner 279
  - z/OS XL C report 256
  - z/OS XL C++ report 270
- INLINE compiler option 602
  - description 119
- INLRPT compiler option 123, 602
- input
  - compiler 291, 300
  - linkage editor 555
  - prelinker 551, 552
  - record sequence numbers 185
- input and output 15
- installation
  - problems 603
  - PTF (Program Temporary Fix) 596
- interaction with other IBM products 18
- Interprocedural Analysis
  - See IPA
- Interprocedural Analysis (IPA) optimization
  - explanation of 499
- IPA
  - enabling 497
  - explanation of 497
  - invoking from the c89 utility 310
  - IPA Compile step
    - flow of processing 312
  - IPA compiler option 124
  - IPA Link step
    - compiler options map listing section 279
    - creating a DLL with IPA 343
    - creating a module with IPA 331
    - error source 599
    - external symbol cross reference listing section 281
    - external symbol dictionary listing section 281
    - flow of processing 313
    - global symbols map listing section 279
    - invoking IPA from the c89 utility 329
    - IPA inliner listing section 279
    - IPA Link step control file 349
    - listing heading information 278
    - listing message summary 282
    - listing messages section 282
    - listing overview 221, 258, 271
    - listing prolog 278
    - object file directives 354
    - object file map listing section 278
    - overview 329
    - partition map listing section 281
    - pseudo assembly listing section 281
    - source file map listing section 278
    - storage offset listing section 281
    - troubleshooting 354
    - using profile-directed feedback 347
  - object modules under IPA 294
  - overview 312
  - using cataloged procedures 297, 298

- IPA (Interprocedural Analysis) optimization
  - explanation of 499
- IPA(OBJONLY) and c89 311
- IPA(OBJONLY) compiler option 314
- IPACNTL data set 424, 426
- IPARM JCL parameter 423
- IRUN JCL parameter 423

## J

- JCL (Job Control Language)
  - C comments 194
  - control statement
    - See control statements
  - ENTRY control statement 558
  - specifying prelinker and linkage editor options 571, 572

## K

- keyboard 623
- KEYWORD compiler option 132

## L

- LANGLVL compiler option 132
- Language Environment 9
- LIB parameter CXXMOD EXEC 575
- LIBANSI compiler option 145
- LIBPATH environment variable
  - used by c89/cc/c++ 499
- library
  - archive
    - creating 479
    - displaying the object files in 479
    - file naming convention for c89 use 479
    - use by application programs 479
  - search sequence
    - with LSEARCH compiler option 153
    - with SEARCH compiler option 183
  - z/OS Language Environment
    - components 557
    - required to run the compiler 291
    - run time 291
- LIBRARY control statement
  - linkage editor and 556
  - prelinker and 573, 584
  - using with linkage editor 573
- LIBRARY JCL parameter 424
- LINK
  - assembler macro 605
  - command
    - input 578
    - LOAD operand 579
    - syntax 578
- link time error 601
- link-edit
  - z/OS C and z/OS C++ object files 490
- linkage editor
  - creating a load module under z/OS batch 570
  - errors 557

- linkage editor (*continued*)
  - function of 563
  - INCLUDE statement and 556
  - input to 555, 564
  - LIBRARY statement and 556
  - options
    - MAPINOMAP 552
    - specifying 570
  - output 555, 556, 564
  - requesting options with c89 580
  - using c89 and xlc to compile and bindt 309
  - using make to compile and bind 311
  - using under TSO 574
- linking 11, 569
  - See also* linkage editor
  - IBM-supplied class libraries 569
  - multiple object modules 557
- LIST compiler option 146, 602
- LIST parameter CXXMOD EXEC 576
- listings
  - all included text 602
  - cross reference 602
  - from linkage editor 555
  - from prelinker 552, 564
  - include file option (SHOWINC) 187
  - IPA Compile step, using 221, 258
  - IPA Link step compiler options map 279
  - IPA Link step external symbol cross reference 281
  - IPA Link step external symbol dictionary 281
  - IPA Link step global symbols map 279
  - IPA Link step heading information 278
  - IPA Link step inliner 279
  - IPA Link step message summary 282
  - IPA Link step messages 282
  - IPA Link step object file map 278
  - IPA Link step partition map 281
  - IPA Link step prolog 278
  - IPA Link step pseudo assembly 281
  - IPA Link step source file map 278
  - IPA Link step storage offset 281
  - IPA Link step, using 271
  - message summary, z/OS XL C 256
  - message summary, z/OS XL C++ 269
  - object code 602
  - object library utility map 437
  - object module option (LIST) 146
  - source file 602
  - using z/OS XL C++ 257
  - z/OS XL C cross reference table 255
  - z/OS XL C external symbol cross reference 257
  - z/OS XL C external symbol dictionary 257
  - z/OS XL C includes section 255
  - z/OS XL C messages 255
  - z/OS XL C object code 257
  - z/OS XL C pseudo assembly listing 257
  - z/OS XL C source program 255
  - z/OS XL C static map 257
  - z/OS XL C structure and union maps 255
  - z/OS XL C, using 220
  - z/OS XL C++ cross reference table 269
  - z/OS XL C++ external symbol cross reference 271

- listings (*continued*)
  - z/OS XL C++ external symbol dictionary 271
  - z/OS XL C++ includes section 269
  - z/OS XL C++ IPA Link step static map 282
  - z/OS XL C++ messages 269
  - z/OS XL C++ object code 271
  - z/OS XL C++ pseudo assembly listing 271
  - z/OS XL C++ source program 269
  - z/OS XL C++ static map 271
- load library
  - storing object modules 579
- load module
  - creating 554
  - inputs for 564
- LOAD parameter CXXMOD EXEC 576
- local environment, defining 475
- local variables 189
- locale
  - converting source definitions for categories 475
  - customizing 473
  - definition file 473
  - DSECT utility option 461
  - object 473
- LOCALE compiler option 148
- localedef shell command 475
- localedef utility
  - TSO 474
  - z/OS batch 474
- long names
  - definition of 550
  - LIBRARY control statement and 584
  - mapping to short names 553
  - RENAME control statement and 585
  - resolving undefined 569
  - support 150
  - unresolved 569
  - UPCASE prelink option and 591
- LONGNAME compiler option 149
- LookAt message retrieval tool xxiii
- LOPT parameter CXXMOD EXEC 575
- LOWERCASE DSECT utility option 462
- LP64 compiler option 150
- LP64 DSECT utility option 462
- LPARM parameter 423, 570
- LRECL (logical record length) parameter
  - DSECT utility option 464
- LRECL DSECT utility option 464
- LSEARCH compiler option 153

## M

- macro
  - assembler
    - ATTACH 605
    - CALL 605
    - compiling z/OS XL C/C++ programs with 605
    - LINK 605
  - expanded in source listing 103
  - expansion 601
  - feature test 316

- maintaining
  - objects in an archive library 479
  - programs through makefiles 480
  - programs with make using c89 311
- make utility
  - compiling and binding application programs 311
  - compiling source and object files 306
  - creating makefiles 480
  - maintaining z/OS XL C/C++ application programs 480
- Makedepend utility 480
- makefiles
  - creating 480
  - maintaining application programs 480
- mangled name filter utility 449
- map
  - load module 556
  - pragma 553
  - prelinker 552, 553, 564
- MAP prelinker option 552, 564, 591
- mapping
  - long names to short names
    - rules for 553
  - of load modules 571
- MARGINS compiler option 158, 598
- MAXMEM compiler option 159
- MEMBER JCL parameter 424
- memory
  - files, compiler work-files 161
  - MAXMEM compiler option 159
  - MEMORY compiler option 161
  - MEMORY prelinker option 591
- message prefixes
  - CCN 595
  - CEE 595
  - EDC 595
  - EQA 595
  - IBM 595
  - IGZ 595
  - others 595
  - PLI 595
- message retrieval tool, LookAt xxiii
- messages
  - directing to your terminal 206
  - generate warning 116
  - on IPA Link step listings 282
  - on z/OS XL C compiler listings 255
  - on z/OS XL C++ compiler listings 269
  - specifying severity of 105
- mismatches, type 598
- MVS (Multiple Virtual System)
  - batch environment
    - running shell scripts and z/OS XL C/C++ applications 481
- natural reentrancy
  - generating 179
  - linking 601
- NCAL prelinker option 591
- NESTINC compiler option 163
- NOAGGREGATE compiler option 68
- NOALIAS compiler option 68
- NOANSIALIAS compiler option 69
- NOARGPARSE compiler option 74
- NOASCII compiler option 75
- NOATTRIBUTE compiler option 76
- NOAUTO prelinker option 591
- NOCALLBACKANY 97
- NOCHECKOUT compiler option 78
- NOCICS compiler option 80
- NOCLASSNAME option of CXXFIL utility 451
- NOCOMPACT compiler option 82
- NOCOMPRESS compiler option 83
- NOCONVLIT compiler option 84
- NOCSECT compiler option 86
- NOCVFT compiler option 89
- NODEBUG compiler option 91
- NODIGRAPH compiler option 95
- NODLL compiler option 97
- NODUP prelinker option 591
- NOER prelinker option 591
- NOEVENTS compiler option 101
- NOEXECOPS compiler option 102
- NOEXH compiler option 103
- NOEXPMAC compiler option 103
- NOEXPORTALL compiler option 104
- NOFASTTEMPINC compiler option 104
- NOFLAG compiler option 105
- NOGOFF compiler option 111
- NOGONUMBER compiler option 111
- NOHALTONMSG compiler option 113
- NOHGPR compiler option 114
- NOHOT compiler option 114
- NOIGNERRNO compiler option 115
- NOINFO compiler option 116
- NOINITAUTO compiler option 118
- NOINLINE compiler option 119
- NOINLRPT compiler option 123
- NOIPA compiler option 124
- NOKEYWORD compiler option 132
- NOLIBANSI compiler option 145
- NOLIST compiler option 146
- NOLOCALE compiler option 148
- NOLONGNAME compiler option 149
- NOLSEARCH compiler option 153
- NOMAP prelinker option 591
- NOMARGINS compiler option 158, 598
- NOMAXMEM compiler option 159
- NOMEMORY compiler option 161
- NOMEMORY prelinker option 591
- Non-XPLINK version of the Standard C++ Library and c89 365
- Non-XPLINK version of the Standard C++ Library and xlc 366
- Non-XPLINK version of the Standard C++ Library and z/OS batch 374

## N

- NAME control statement 551, 556
- NAMEMANGLING compiler option
  - NAMEMANGLING compiler option 161

NONCAL prelinker option 591  
 NONESTINC compiler option 163  
 NOOBJECT compiler option 163  
 NOOE compiler option 165  
 NOOFFSET compiler option 166  
 NOOPTFILE compiler option 167  
 NOOPTIMIZE compiler option 169, 598  
 NOPORT compiler option 174  
 NOPPONLY compiler option 175  
 NOREDIR compiler option 178  
 NOREGULARNAME option of CXXFILT utility 450  
 NORENT compiler option 178  
 NOROCONST compiler option 179  
 NOROSTRING compiler option 181  
 NORTTI compiler option 183  
 NOSEARCH compiler option 183  
 NOSEQUENCE compiler option 185, 598  
 NOSERVICE compiler option 186  
 NOSHOWINC compiler option 187  
 NOSIDEBYSIDE option of CXXFILT utility 450  
 NOSOURCE compiler option 187  
 NOSPECIALNAME option of CXXFILT utility 451  
 NOSPILL compiler option 188  
 NOSPLITLIST compiler option 190  
 NOSQL compiler option 193  
 NOSSCOMM compiler option 194  
 NOSTART compiler option 195  
 NOSTATICINLINE compiler option 195  
 NOSTRICT compiler option 196  
 NOSTRICT\_INDUCTION compiler option 197  
 NOSUPPRESS compiler option 198  
 NOSYMMAP option of CXXFILT utility 450  
 NOTEMPINC compiler option 203  
 NOTEMPLATERECOMPILE compiler option 204  
 NOTEMPLATEREGISTRY compiler option 205  
 NOTERMINAL compiler option 206  
 NOTEST compiler option 206  
 Notices 625  
 NOUPCASE prelinker option 591  
 NOUPCONV compiler option 214  
 NOWARN64 compiler option 215  
 NOWIDTH option of CXXFILT utility 450  
 NOWSIZEOF compiler option 215  
 NOXPLINK compiler option 216  
 NOXREF compiler option 220

## O

OBJ parameter for CXXMOD EXEC 575

object

code 291

library utility

adding object modules 437

deleting object modules 437

listing the contents 437

TSO 439

z/OS batch 437

module

additional object modules as input 556

creating 573

DLL compiler option 97

object (*continued*)

module (*continued*)

EXPORTALL compiler option 104

link-editing multiple modules 557

LIST compiler option 146

OBJECT compiler option 163

optimization 169

storing in a load library 579

TARGET compiler option 198

z/OS XL C object listing 257

z/OS XL C++ object listing 271

OBJECT

compiler option 163

JCL parameter 424

object code, listing 602

object files

object file browse 315

working with 315

object files variations

object file variation identification 316

Object Library Utility

example under z/OS batch 437

long name support 437

map

heading 447

member heading 447

symbol definition map 448

symbol information 448

symbol source list 448

user comments 447

OBJECTMODEL compiler option 165

OE compiler option 165

OFFSET compiler option 166, 602

OGET utility 308, 415

OGETX utility 415

OMVS

OE compiler option 165

OPARM JCL parameter 424

OPTFILE compiler option 167

optimization

object module 169

OPTIMIZE compiler option 169

storage requirements 169

TMPLPARSE compiler option 210

TUNE compiler option 211

OPTIMIZE compiler option 169, 598

optional features 490

options

compiler

See compiler options

CXXFILT 449

linkage editor 556

prelinker

See prelinker, options

run-time 287

OPUTX utility 415

OUTFILE parameter 423

output

from the linkage editor 555, 556

from the prelinker 552

OUTPUT DSECT utility option 464

## P

- PARM parameter 571
- passing arguments 288
- PCH (precompiled header)
  - See precompiled headers
- PDF documents xxii
- performance
  - C/C++ programs
    - FLOAT 492
    - XPLINK 500
- PHASEID compiler option 172
- PLI message prefix 595
- PLIB parameter CXXMOD EXEC 575
- PLIST compiler option 173
- PMAP parameter CXXMOD EXEC 576
- PMOD parameter CXXMOD EXEC 575
- POPT parameter CXXMOD EXEC 575
- PORT compiler option 174
- PPARM
  - JCL parameter 424
  - parameter 570
- PPCOND DSECT utility option 462
- PPONLY compiler option 175, 598, 602
- pragmas
  - csect 553
  - map 553
  - options 49
  - runopts 287
  - See runtime options
- prelinker
  - building and using DLLs 559
  - error source 600
  - function of 563
  - functions of 550
  - IBM-supplied class libraries 569
  - IMPORT statement and 583
  - INCLUDE statement and 583
  - input 551, 552, 563
  - LIBRARY statement and 584
  - load modules 600
  - map 552, 564
  - mapping long names to short names 553
  - messages from 552
  - options
    - MAPINOMAP 564
    - specifying 570
  - output from 551, 552, 563, 577
  - overview 549
  - RENAME statement and 585
  - resolving undefined symbols 569
  - under z/OS batch 572
  - usage 549
- prelinking 11
- preprocessor directives
  - effects of PPOONLY compiler option 175
  - include 316
- preprocessor, diagnostic information 602
- preventive service planning (PSP) bucket 596, 603
- primary data set
  - specifying input to the compiler 291
  - specifying input to the linkage editor 555

- primary input
  - compiler 291
  - linkage editor 555
  - to the linkage editor 555
  - to the prelinker 551
- processing a C program
  - z/OS XL C sample program, under TSO 28
  - z/OS XL C sample program, under z/OS Batch 27
- Profile-Directed Feedback 129
- program management binder 13
- programming errors 78
- PSP (preventive service planning) bucket 596, 603
- PTF (Program Temporary Fix) 596

## R

- RECFM DSECT utility option 464
- record margins 158
- REDIR compiler option 178
- reentrancy 524
  - linking 600
  - RENT compiler option 178
- reentrant code
  - linking 600
  - RENT compiler option 178
- region size 409
- regular names used with CXXFILT 449
- REGULARNAME option of CXXFILT utility 450
- release changes 3
- RENAME control statement
  - mapping long names to short names 553
  - syntax 585
- RENT compiler option syntax 178
- REXX EXECs
  - supplied by IBM
    - C370LIB 419
    - CC, new syntax 419
    - CC, old syntax 431
    - CDSECT 419
    - CMOD 431, 432
    - CPLINK 576
    - CXXBIND 419
    - CXXMOD 419
    - EDCLDEF 474
    - GENXLT 419, 472
    - ICONV 419, 470
    - LOCALEDEF 419
- ROCONST compiler option 179
- ROSTRING compiler option 181
- ROUND compiler option 182
- RTTI compiler option 183
- run-time
  - errors 601
  - options
    - in the EXEC statement 411
    - recognize at run time 102
    - specifying 287
    - under z/OS batch 410
    - under z/OS UNIX System Services 415
    - specifying run-time environment 198
- run-time library file types 16



- running programs
  - TSO
    - example 413
    - specifying run-time options 413
    - with CALL TSO command 412
  - z/OS batch
    - BPXBATCH 416
    - example 411
    - with EXEC JCL statement 410
  - z/OS UNIX System Services application 414

## S

- sample program
  - processing z/OS XL C under TSO 28
  - processing z/OS XL C under z/OS Batch 27
  - z/OS XL C source 25
  - z/OS XL C++ source 31
- SCEECPP library 575
- SCEELKED library 564, 575
- SEARCH compiler option 183
  - using to compile z/OS XL C code 327
  - using to compile z/OS XL C++ code 328
- search sequence
  - library files 410
  - system include files 184
  - user include files 153
- secondary data set
  - libraries 301
  - secondary input to the linkage editor 556
- secondary input
  - compiler 292, 301
  - linkage editor 556
  - to the linkage editor 555
  - to the prelinker 551
- SECT DSECT utility option 455
- select format of floating-point numbers
  - FLOAT 492
- SEQUENCE compiler option 185, 598
- SEQUENCE DSECT utility option 463
- sequence numbers on input records 185
- SERVICE compiler option 186
- serviceability
  - C/C++ programs
    - GONUMBER 494
- shell
  - compiling and linking using c89 307
  - invoking load modules 415
  - using BPXBATCH to run commands or scripts 481
- short names
  - automatic library call processing 569
  - definition of 550
  - mapping 553
  - unresolved 569
- shortcut keys 623
- SHOWINC compiler option 187, 602
- SIDEBYSIDE option of CXXFILT utility 450
- singlebyte character conversions 471
- source
  - file listing 602

- source (*continued*)
  - program
    - comment (SSCOMM compiler option) 194
    - compiler listing options 187
    - file names in include files 317
    - generating reentrant code 178
    - input data set 291
    - margins 158
    - SEQUENCE compiler option 185
  - source code
    - compiling using c89 305
    - z/OS XL C sample program 25
    - z/OS XL C++ example program 31
  - SOURCE compiler option 187, 602
  - source definitions
    - converting for locale categories 475
  - special characters, escaping 48, 298, 304
  - special names used with CXXFILT 449
  - SPECIALNAME option of CXXFILT utility 451
  - spill area
    - changing the size of 189
    - definition of 189
    - pragma 189
  - SPILL compiler option 188
  - SPLITLIST compiler option 190
  - SQL compiler option 193
  - SSCOMM compiler option 194
  - standard files, allocation for BPXBATCH 481
  - standards
    - ANSI compiler option 132
    - LIBANSI compiler option 145
  - START compiler option 195
  - statement
    - failure in 602
    - switch 602
  - STATICINLINE compiler option 195
  - STEPLIB
    - data set 424, 425, 427
    - ddname 550
    - prelinker 551
  - storage optimization 169
  - STRICT compiler option 196
  - STRICT\_INDUCTION compiler option 197
  - structure and union maps, z/OS XL C compiler listing 255
  - stub routines
    - contents of 557
    - in z/OS Language Environment 557
  - SUPPRESS compiler option 198
  - switch statement 602
  - SYMMAP option of CXXFILT utility 450
  - syntax diagrams
    - how to read xvi
  - SYSCPRT data set 294, 424, 426, 427
  - SYSDEFSD data set
    - description 427, 428
    - prelinker and 550, 551
  - SYSEVENT data set
    - description of 426
  - SYSIN data set for stdin
    - description of 425, 426

SYSIN data set for stdin (*continued*)  
     primary input to prelinker 550, 551, 563  
     primary input to the compiler 300  
     usage 424  
 SYSLIB data set  
     description of 425, 427  
     linkage editor and 554, 555, 564  
     prelinker and 550, 551, 563  
     secondary input to linkage editor 556  
     specifying 301  
     usage 292, 424  
 SYSLIN data set  
     description of 425, 427  
     linkage editor and 554, 555, 563  
     primary input to linkage editor 555  
     usage 424  
     with OBJECT compiler option 294  
 SYSLMOD data set 424, 554, 555, 564  
 SYSMOD data set 424, 550, 552, 564  
 SYSMSGs data set 424, 550, 551  
 SYSOUT data set  
     description of 425, 427, 430  
     prelinker and 550, 552  
     usage 424  
 SYSPRINT data set  
     linkage editor and 554, 555  
     prelinker and 550  
     usage 424  
 system  
     files and libraries 167, 183  
     programmer, establishing library access 302, 412  
 system header files 301  
 System Programming C facility 17  
 SYSUT1 data set 424, 426, 554, 555  
 SYSUT5-10 data sets 426

## T

TARGET compiler option 198  
 tasks  
     avoiding installation problems  
         steps for 603  
     binding each compile unit under TSO  
         steps for 381  
     binding each compile unit under z/OS batch  
         steps for 368  
     binding each compile unit using c89  
         steps for 362  
     building a module in UNIX System Services using PDF  
         steps for 349  
     building and using a DLL under TSO  
         steps for 381  
     building and using a DLL under z/OS batch  
         steps for 370  
     compiling, binding, and running the C example program using TSO commands  
         steps for 28  
     compiling, binding, and running the C example program using UNIX commands  
         steps for 29

tasks (*continued*)  
     compiling, binding, and running the C++ example program using TSO commands  
         steps for 37  
     compiling, binding, and running the C++ example program using UNIX commands  
         steps for 38  
     compiling, binding, and running the C++ template example program under z/OS batch  
         steps for 41  
     compiling, binding, and running the C++ template example program using UNIX commands  
         steps for 44  
     compiling, running, and binding the C++ template example program using TSO commands  
         steps for 43  
     diagnosing errors that occur at compile time  
         steps for 598  
     diagnosing errors that occur at IPA Link time  
         steps for 599  
     diagnosing errors that occur at run time  
         steps for 601  
     generating a reentrant load module in C  
         steps for 587  
     generating a reentrant load module in C++  
         steps for 588  
     problem diagnosis using optimization levels  
         steps for 597  
     rebinding a changed compile unit under TSO  
         steps for 382  
     rebinding a changed compile unit under z/OS batch  
         steps for 375  
     rebinding a changed compile unit using c89  
         steps for 364  
     single final bind under TSO  
         steps for 380  
     single final bind under z/OS batch  
         steps for 367  
     single final bind using c89  
         steps for 361  
     steps for building and using a DLL using c89  
         steps for 363  
     utilizing PDF optimization  
         steps for 347  
 technical support xxiv  
 TEMPINC compiler option 203  
 TEMPLATERECOMPILE compiler option 204  
 TEMPLATEREGISTRY compiler option 205  
 templates  
     create template instantiation output 294  
     program example 39  
 TERMINAL compiler option 206  
 test case, creating 597, 598  
 TEST compiler option 206, 602  
 TEXT deck 596  
 TMPLPARSE compiler option 210  
 trigraph 598  
 TSO (Time Sharing Option)  
     compiling under 302  
     creating an object library  
         See Object Library Utility

TSO (Time Sharing Option) *(continued)*  
  LINK command 579  
TUNE compiler option 211  
type conversion, preserving unsignedness 214  
type conversions 214  
type mismatches 598  
typographical conventions xv

## U

UNDEFINE compiler option 213  
UNIQUE DSECT utility option 463  
UNIX System Services 13  
UNIX System Services C functions 15  
unknown names input to CXXFILT utility 451  
UNNAMED DSECT utility option 464  
unprintable character 598  
UNROLL compiler option 213  
unsignedness preservation, type conversion 214  
UPCASE prelinker option 591  
UPCONV compiler option 214  
user  
  comments, object library utility map 447  
  include files  
    LSEARCH compiler option 153  
    SEARCH compiler option 183  
    specifying with #include directive 316  
  prefix 27, 36  
USERLIB 155, 193, 301, 426  
USL 8  
utilities  
  CXXFILT 449  
  mangled name filter 449  
  z/OS UNIX System Services 479  
  z/OS XL C 419  
  z/OS XL C, old syntax 431  
  z/OS XL C++ 419

## W

WARN64 compiler option 215  
WIDTH option of CXXFILT utility 450  
work data sets 424  
writable static  
  object library 437  
  prelinker and 552  
  relative offsets 550  
WSIZEOF compiler option 215

## X

XL C compiler-specific features 8  
XL C/C++ compiler utilities 9  
XL C++ compiler-specific features 8  
xlc 528  
xIC 528  
xlc utility 527  
xlc\_64 528  
xIC\_64 528  
xlc\_x 528  
xIC\_x 528

xlc/xIC shell command  
  environment variables 530  
  specifying  
    system and operational information to  
      xlc/xIC 530  
xlc++ 528  
xlc++\_64 528  
xlc++\_x 528  
XPLINK  
  C/C++ programs 500  
  compiler option 216  
  extra performance linkages 500  
  improved performance 500  
XREF compiler option 220, 602

## Z

z/OS batch  
  compiling under 296, 331  
  link-editing 573  
  running shell scripts and z/OS XL C/C++  
    applications 481  
  running your program 410  
z/OS Language Environment 9  
z/OS UNIX System Services 13  
  compiling and binding using c89 306  
  compiling and binding using compiler invocation  
    command names supported by c89 and xlc 309  
  compiling and binding using make 311  
  maintaining objects in an archive library 479  
  maintaining through makefiles 480  
  OE compiler option 165  
  placing z/OS load modules in z/OS UNIX System  
    Services 415  
z/OS UNIX System Services C functions 15  
z/OS XL C compiler-specific features 8  
z/OS XL C/C++ compiler utilities 9  
z/OS XL C++ compiler-specific features 8







Program Number: 5694-A01 and 5655-G52

Printed in the United States of America

SC09-4767-05

